

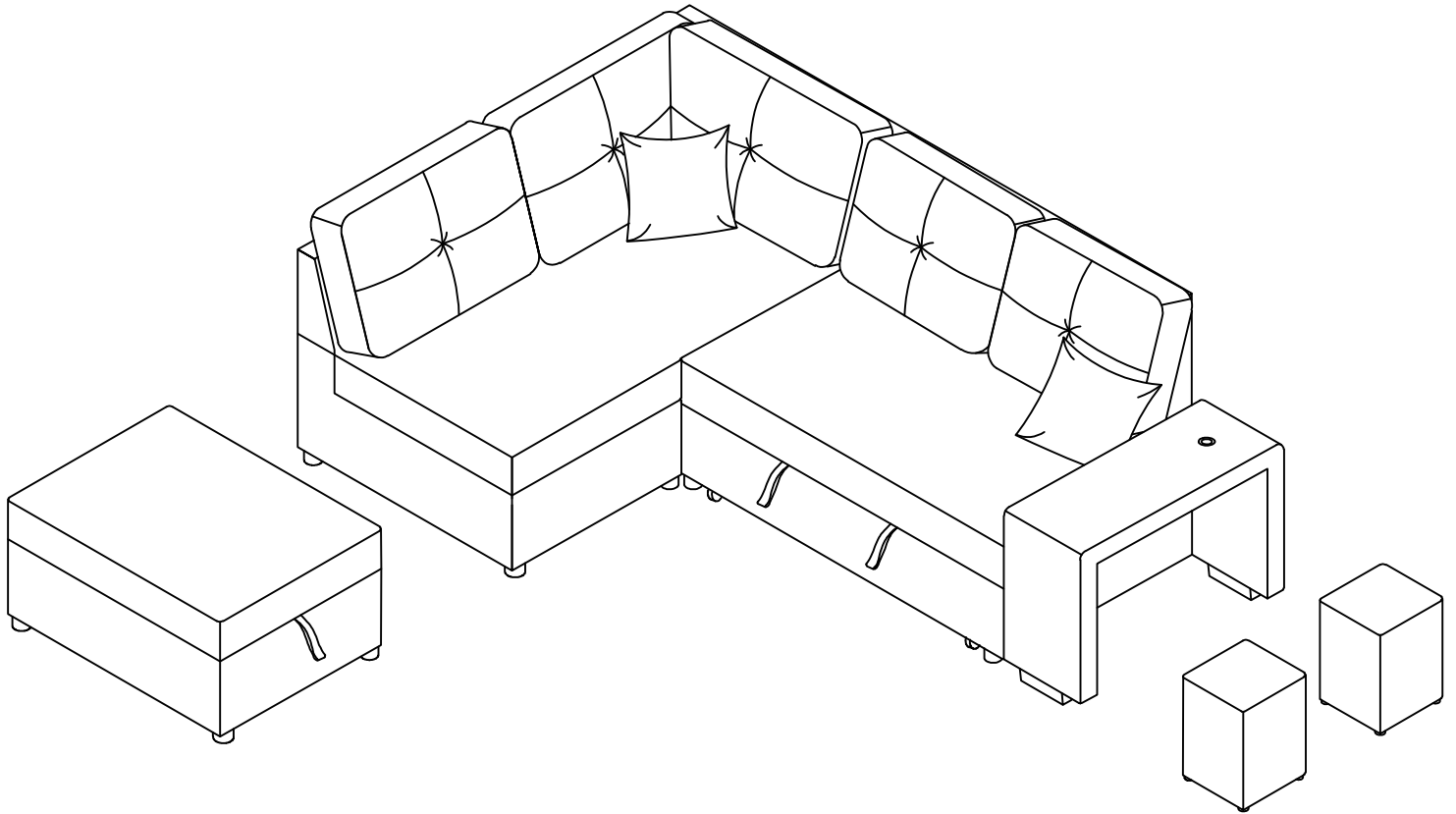







ASSEMBLY INSTRUCTION









ITEM NO.: WF314622 -WF314623-WF314624-WF314625





WF314622-COMPONENT LIST

NO.	DRAWING	QTY	DESCRIPTION
A		1	Loveseat Body
E		1	Loveseat Backrest
I		1	Corner Backrest
F		1	Back Cushion
K		1	Long Corner Back Cushion
L		1	Short Corner Back Cushion
B		4	Round legs
J		1	Loveseat Backrest



WF314623-COMPONENT LIST

NO.	DRAWING	QTY	DESCRIPTION
D		1	Loveseat Body
F		2	Back Cushions
M		2	Square Legs
N		4	Bolt 5/16"X50mm
O		1	Allen key
R		4	Wheels
S		4	Bolt Ø1/4"x20MM
B		4	Round legs

WF314624-COMPONENT LIST

C		1	Arm
H		2	Small ottomans

WF314625-COMPONENT LIST

NO.	DRAWING	QTY	DESCRIPTION
G		1	Ottoman
P		2	Pillows
B		4	Round legs

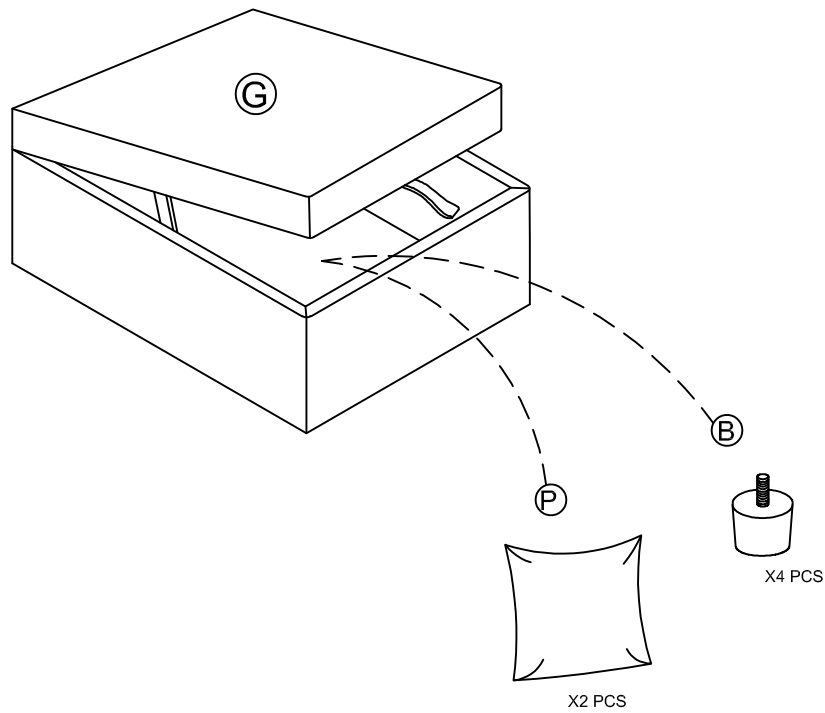

* Open the seat cushion (G)

** Take out the (P), (B)

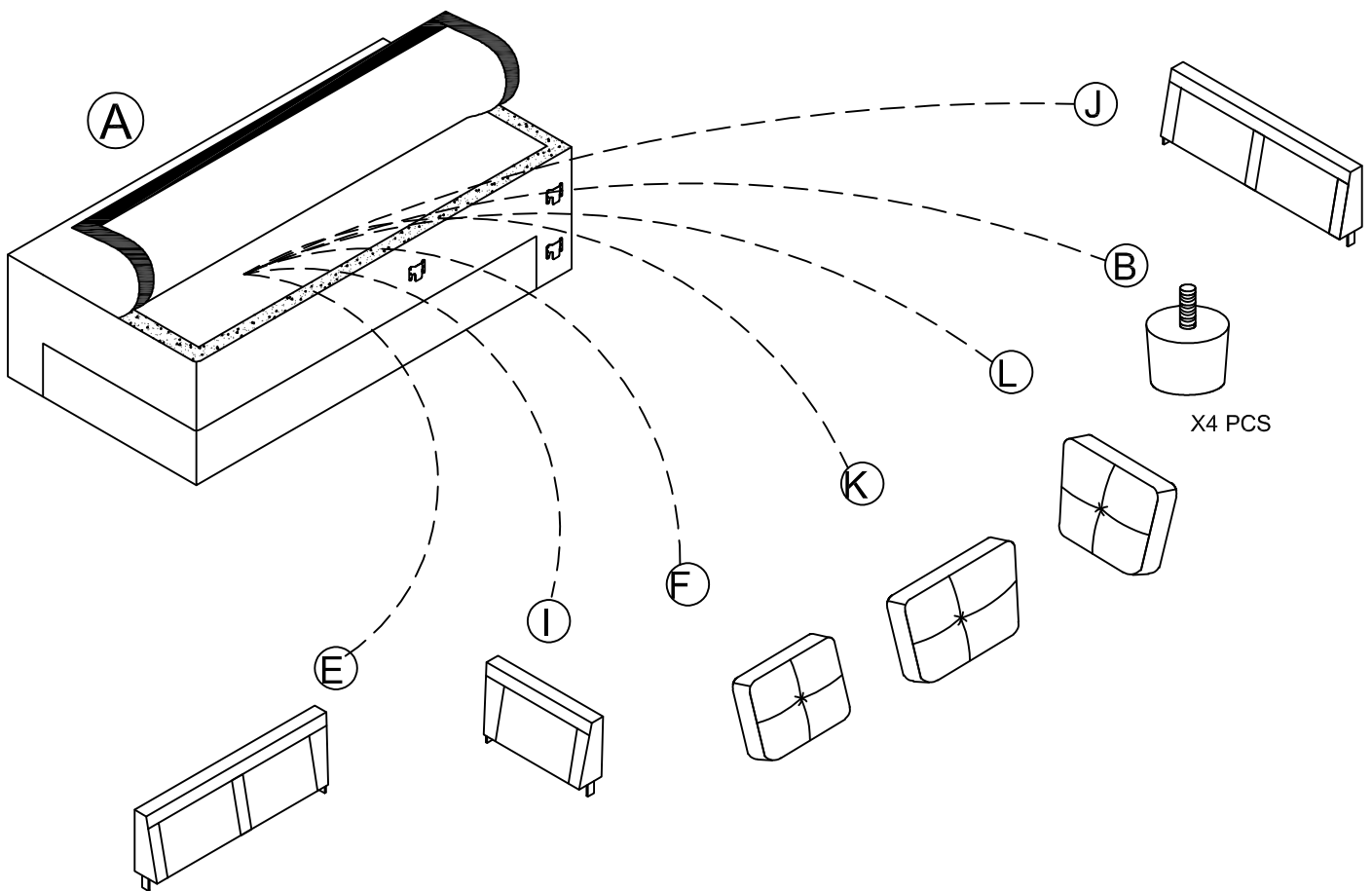



* Turn upside down the (A)

** Take out the (E), (I), (F), (K), (L), (B), (J)

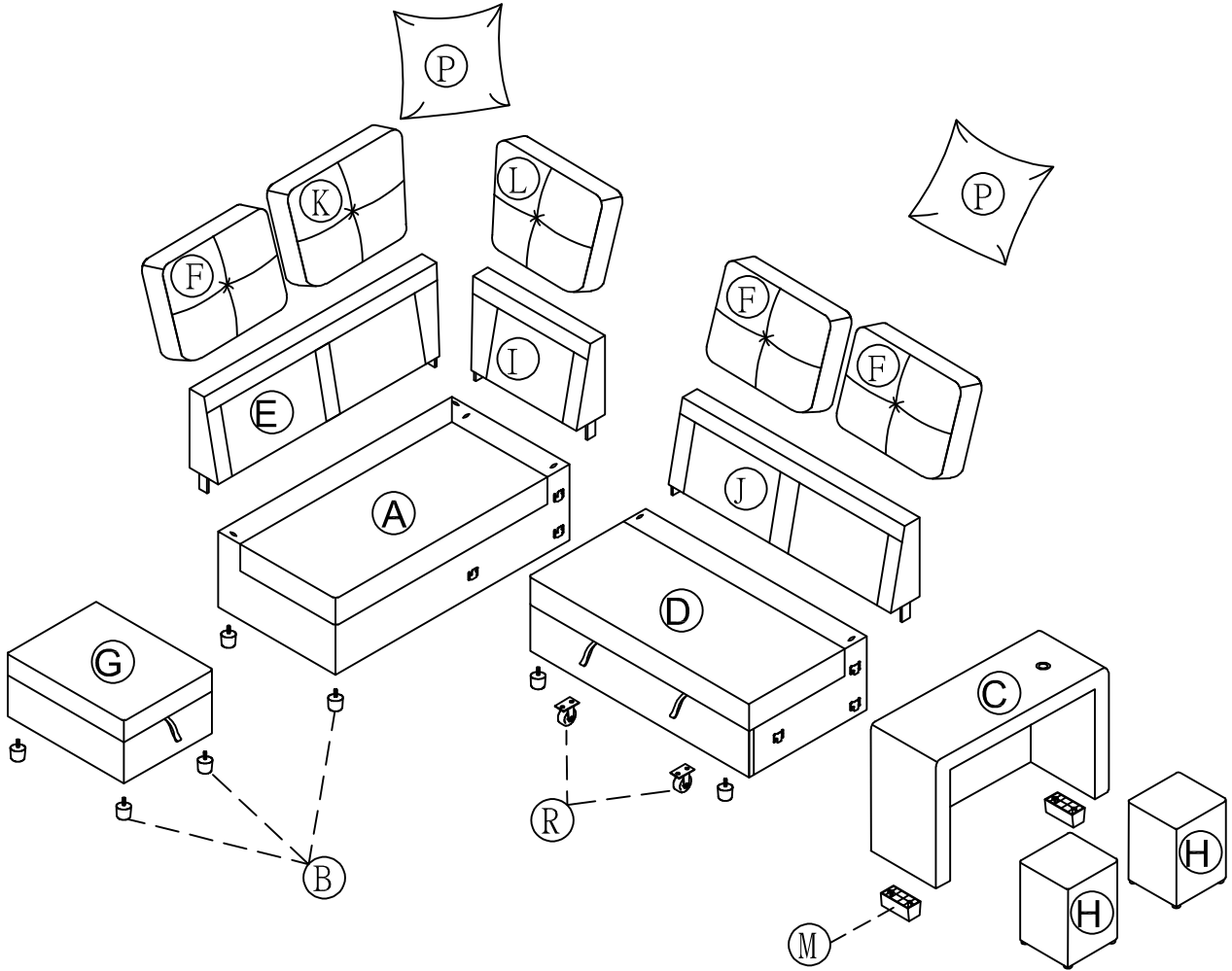
PARTS LIST

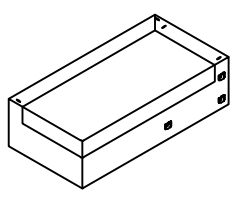
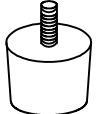
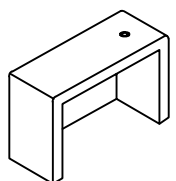
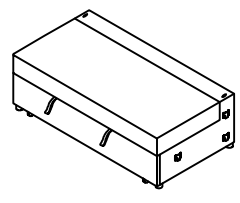
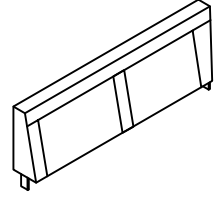
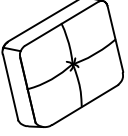
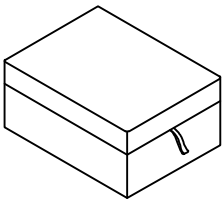
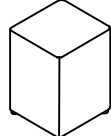
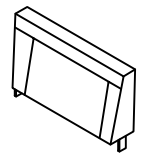
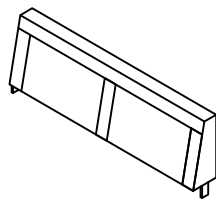
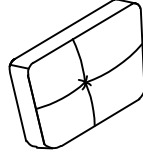
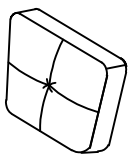
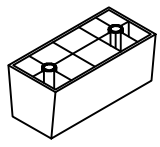
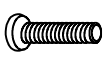

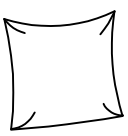
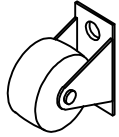
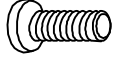
					
<p>Loveseat Body X 1PC</p>	<p>Round legs X 12 PCS</p>	<p>Arm X 1PC</p>	<p>Loveseat Body X 1PC</p>	<p>Loveseat Backrest X 1PC</p>	<p>Back Cushion X 3PCS</p>
					
<p>Ottoman X 1PC</p>	<p>Small ottoman X 2PCS</p>	<p>Corner Backrest X 1PC</p>	<p>Loveseat Backrest X 1PC</p>	<p>Long Corner Back Cushion X 1PC</p>	<p>Short Corner Back Cushion X 1PC</p>
					
<p>Square Legs X 2PCS</p>	<p>Bolt Ø5/16"x50MM X 4 PCS</p>	<p>Allen key X 1PC</p>	<p>Pillows X 2PCS</p>	<p>Wheels X 4 PCS</p>	<p>Bolt Ø1/4"x20MM X 4 PCS</p>

STEP 1:

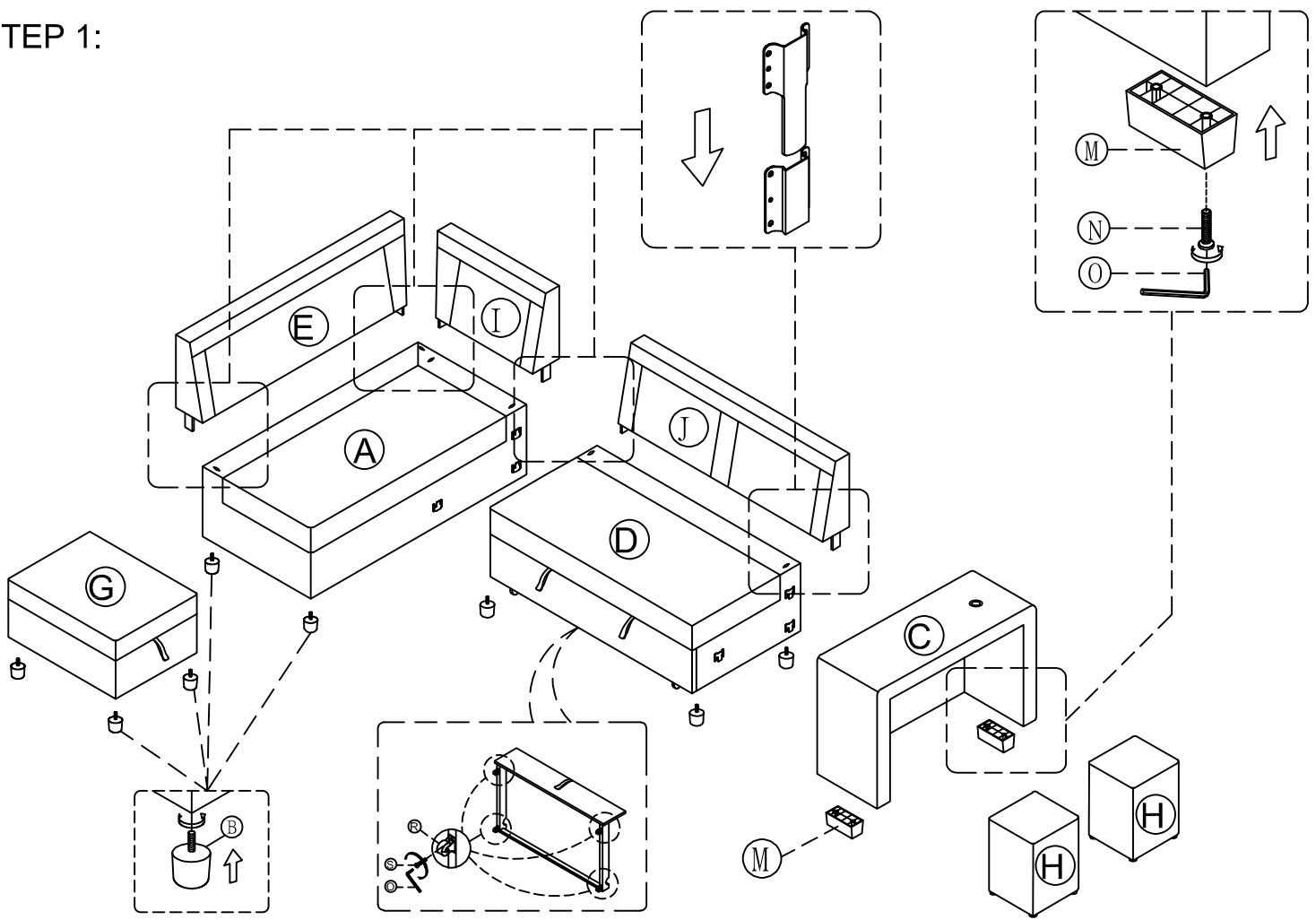

STEP 2:

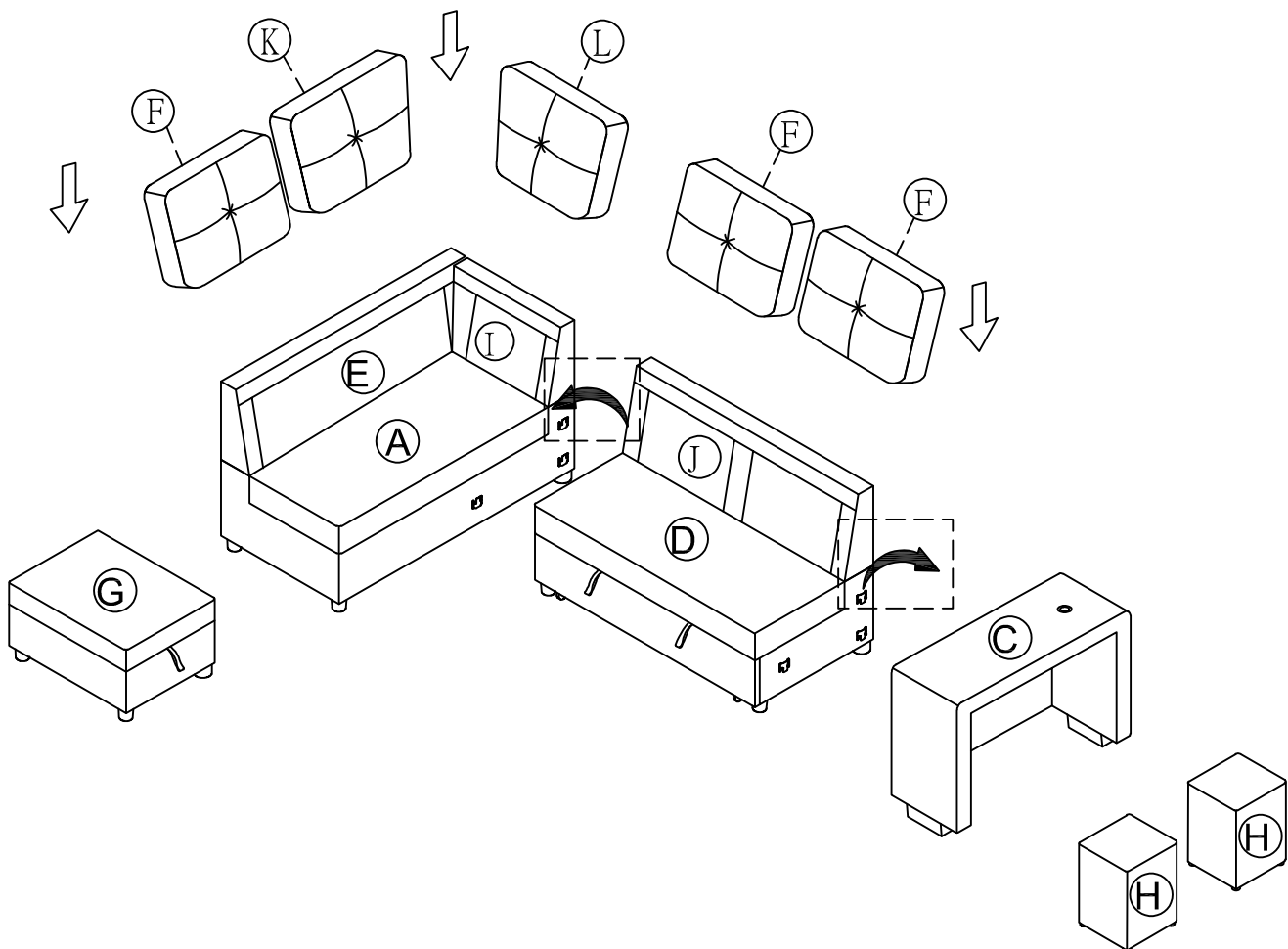

Helpful Hints

- Sofa bed can transform into a sleeper
- Move your new furniture carefully, with two people lifting and carrying the unit to its new location.
- Your furniture can be disassembled and reassembled to move.
- Clean the product with a soft damp cloth. DO NOT use harsh chemicals or abrasive cleaners.

COMPLETED

