



# ASSEMBLY INSTRUCTIONS



**(BOX 1)**  
BOX OF DRESSER

| NO | ITEM   | QTY   |
|----|--|-------|
| A  | DRESSER<br>           | 1 pc  |
| B  | BUN FOOT<br>          | 4 pcs |
| C  | BOTTOM CENTER LEG<br> | 1 pc  |

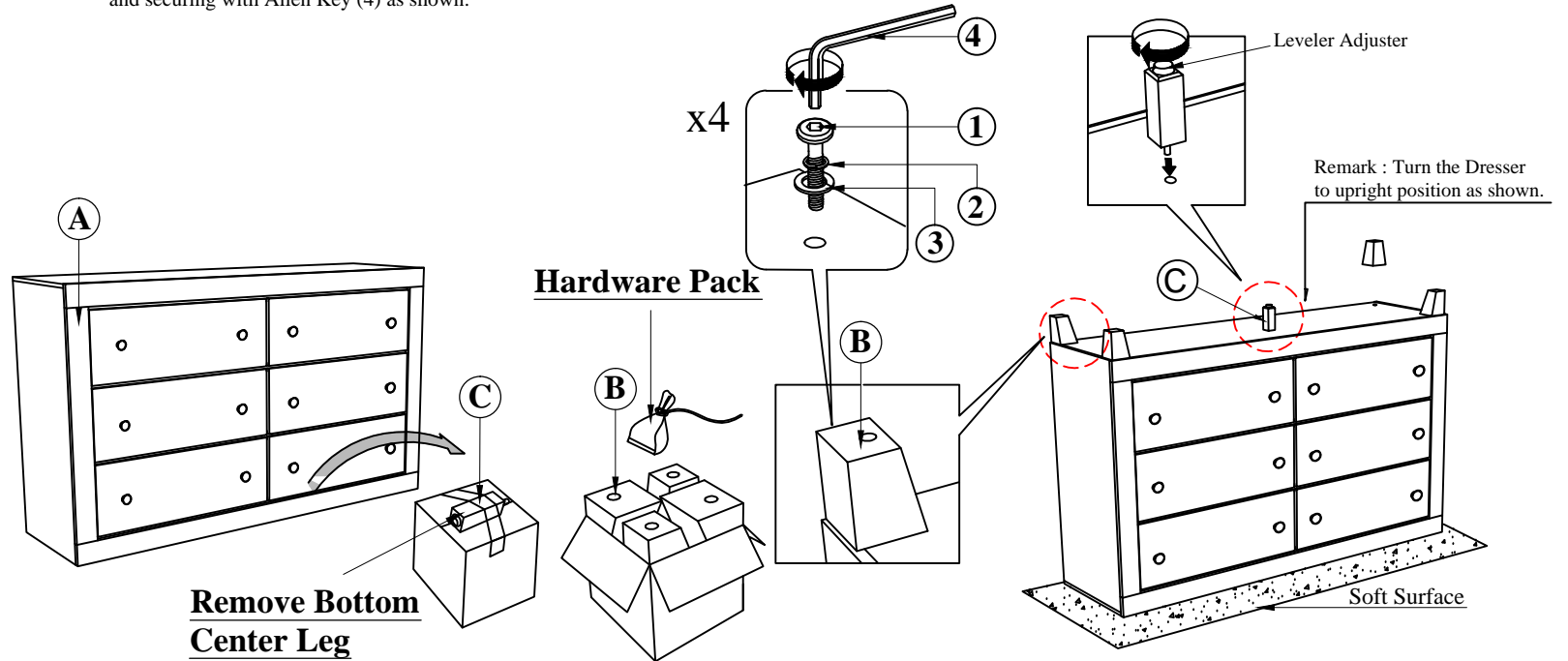
**STEP 1 :** Pull the bottom drawer and take out the Bunfoot carton ( B ). Assemble the Bun Foot (B) with JCBC Bolt (1),Spring washer (2),Flatwasher (3) and securing with Allen Key (4) as shown.

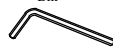

**(BOX 1)**  
HARDWARE LIST

| NO | ITEM  | QTY   |
|----|---|-------|
| 1  | JCBC Bolt m6x50mm Blk<br>            | 4 pcs |
| 2  | Spring Washer 1/4" Blk<br>           | 4 pcs |
| 3  | Flat Washer 1/4"IDx13mmOD Blk<br>    | 4 pcs |
| 4  | Allen Key m4x110mm With Ball Blk<br> | 1 pc  |



**COMPLETED ASSEMBLY**

NOTE : MUST TIGHTEN SCREWS **PERIODICALLY** WITH USE SCREW WILL BECOME LOOSE CHECK TIGHTNESS OF ALL SCREW EVERY 6-8 WEEKS.