

# INSTALLATION GUIDE

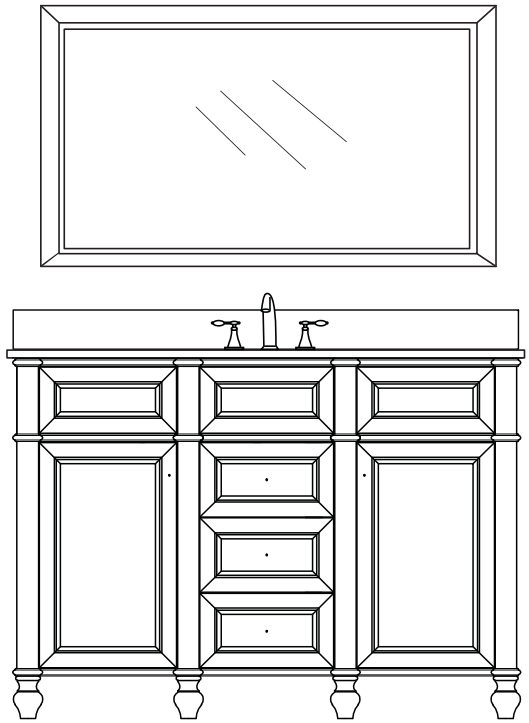

# INSTALLATION MANUAL

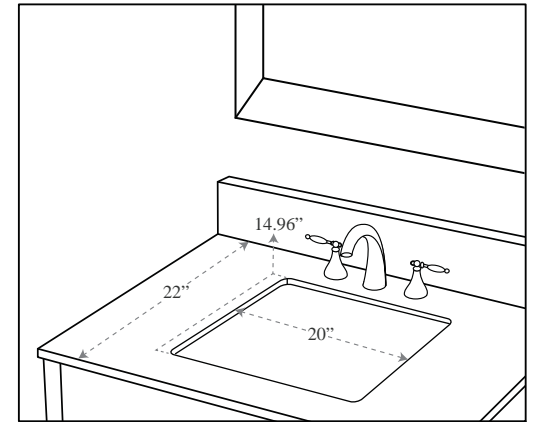
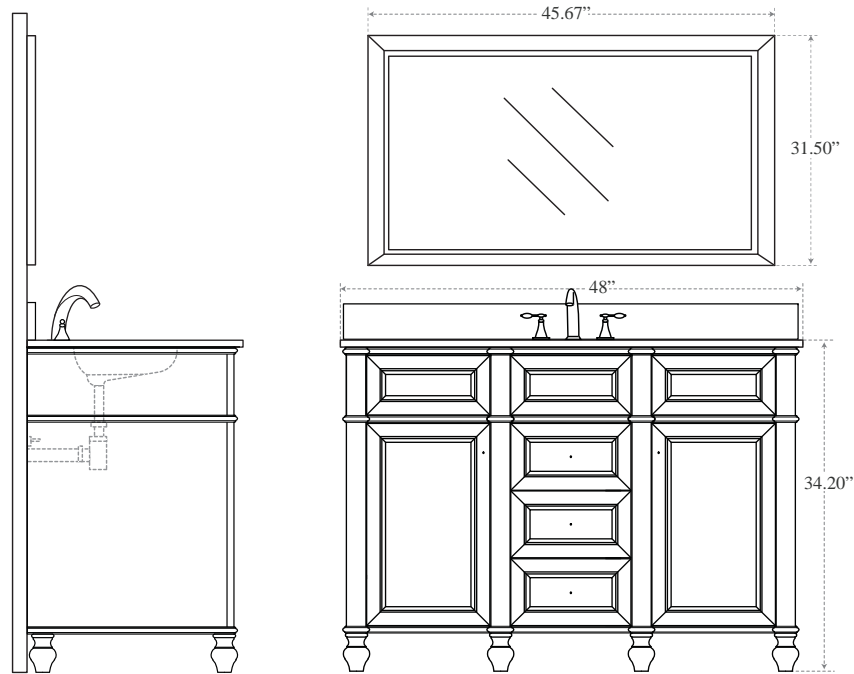

## PACKING LIST *(Not all components may be included, depending upon your purchase)*

### SAFETY & PRECAUTIONS

1. Recommends you to review the Installation Manual before starting the vanity installation.
2. Please handle heavy objects with care and support to avoid mishaps damages or injuries.
3. After completing the installation, please wait up to 24-hours before using the vanity.
4. When cleaning the top or cabinet use mild strength for scrubbing to avoid scratching the surface.
5. Professional installation recommended.

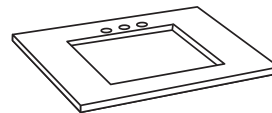
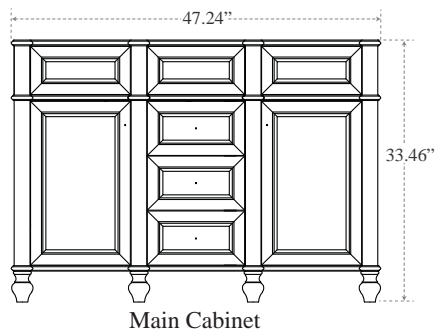

Optional: Countertop

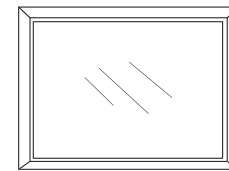

Optional: Mirror

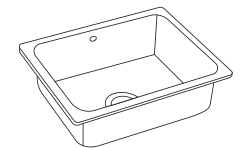

Optional: Square Sink

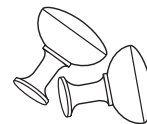

Cabinet Hardware

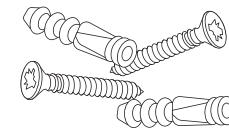

Mirror Installation Screws

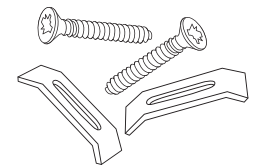

Sink Mounting Kit

## RECOMMENDED TOOLS

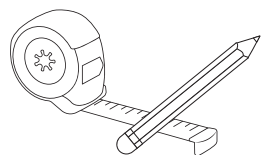

Pen & Ruler

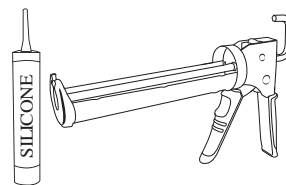

Caulk & Caulk Gun

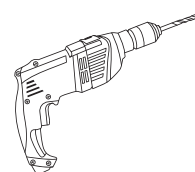

Power Drill

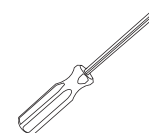

Phillips Screwdriver

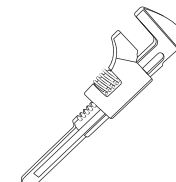

Adjustable Wrench

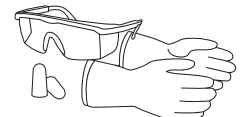

Goggles, Gloves & Ear Plugs

## HINGES INSTALL & ADJUSTMENT

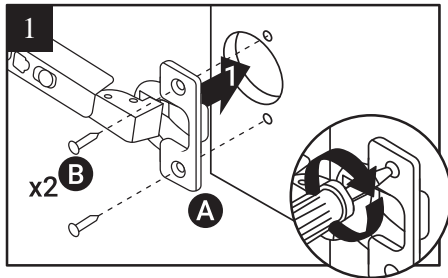

1. Attach hinge (A) to door with screws (B).

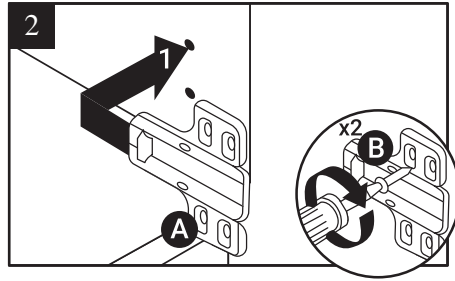

2. Attach mounting plate (A) to cabinet with screw (B).

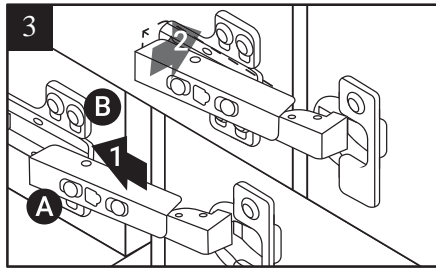

3. Attach hinge (A) to mounting plate (B) and snap into position.

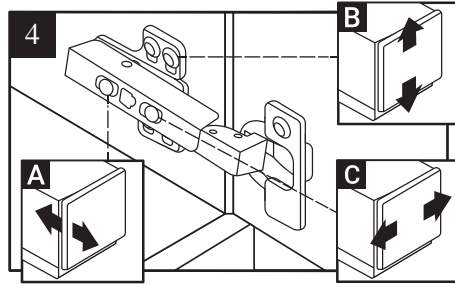

4. Align door to cabinet. Use screw (A) to adjust door depth, screw (B) to adjust vertically and screw (C) to adjust horizontally.

## OPTIONAL: SINK INSTALLATION

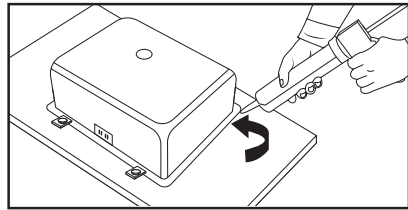

- Apply a continuous stream of silicone glue around the sink top rim. Flip the countertop upside down.
- Carefully align the sink onto countertop back, fasten the sink rim with the sink mounting screws.
- Apply a continuous silicone glue along the sink edges to seal any gaps.

## OPTIONAL: MIRROR INSTALLATION

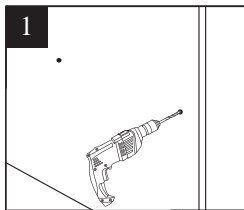

1. Measure the screw holes from the backside of mirror (Fig. A) distance. Then drill the holes into the wall.

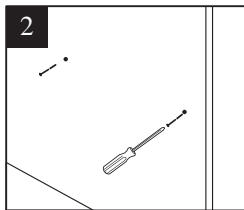

2. Insert the anchor screws into the holes and drill the screws into them.

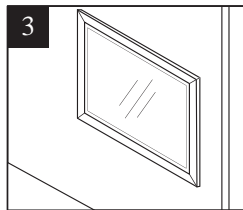

3. Hang up the mirror into position and it's done.

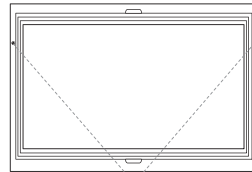
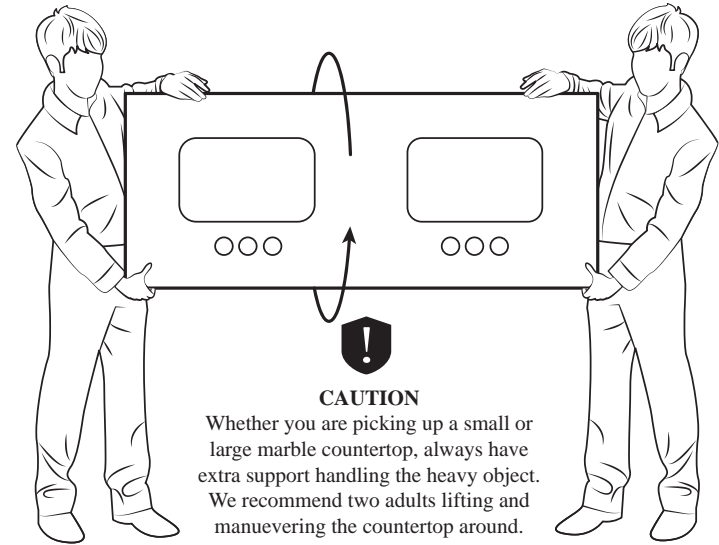

Fig. A

## HOW TO CARRY THE TOP



**CAUTION**  
Whether you are picking up a small or large marble countertop, always have extra support handling the heavy object. We recommend two adults lifting and maneuvering the countertop around.

## OPTIONAL: TOP & BACKSPLASH INSTALLATION

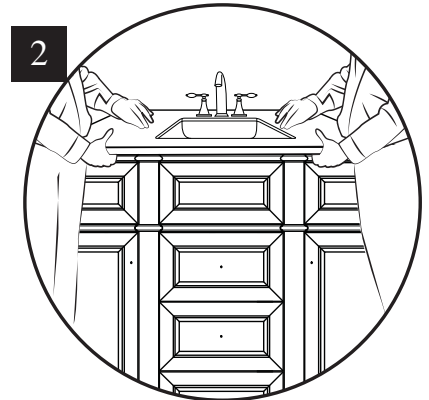
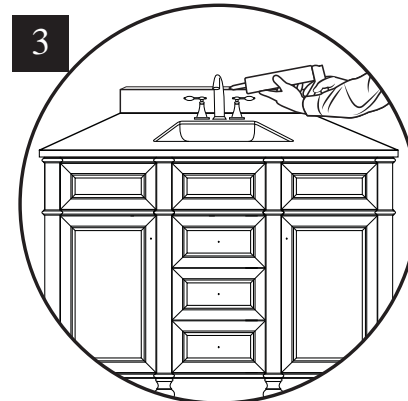
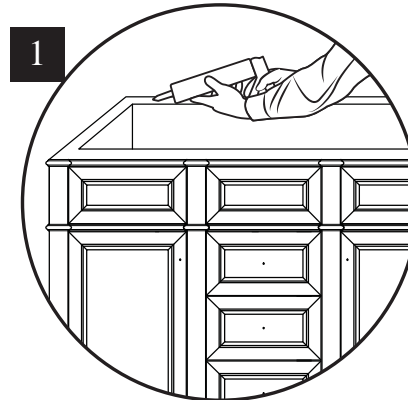

1. Apply a continuous stream of silicone glue around the top of the cabinet.

2. Carry the countertop and gently place it onto the cabinet.

3. Install the backsplash by applying silicone glue near the edge of the countertop. Then place the backsplash onto the silicone area. Add additional silicone onto the edges for sealant if necessary.

**Note:** Allow up to 24-hours for the silicone glue to dry before using the vanity.