











# Assembly Instructions

**Caution: You must read this before you proceed**

## Care & Maintenance

	<ul style="list-style-type: none"><li>● Not for commercial use. For residential use only.</li></ul>
	<ul style="list-style-type: none"><li>● Furniture may scratch floors. We recommend using furniture pads to protect your floors.</li></ul>
	<ul style="list-style-type: none"><li>● Do not put hot items directly on furniture surface.</li></ul>
	<ul style="list-style-type: none"><li>● Do not clean furniture with harsh cleansers or polish.</li></ul>
	<ul style="list-style-type: none"><li>● Do not place furniture under direct sunlight.</li></ul>
	<ul style="list-style-type: none"><li>● Do not place furniture near heating or cooling vents.</li></ul>
	<ul style="list-style-type: none"><li>● Do not write on furniture without a padded barrier to protect the surface.</li></ul>
	<ul style="list-style-type: none"><li>● Do not place furniture outside . For indoor use only.</li></ul>
	<ul style="list-style-type: none"><li>● Stains may be removed with mild soap solution and damp cloth.</li></ul>
	<ul style="list-style-type: none"><li>● Children should not climb or jump on the furniture.</li></ul>
	<ul style="list-style-type: none"><li>● Dust and pick-up spills using a clean, non-colored, lint-free cloth.</li></ul>

Please look in the magic tape pouch for hardware packs and legs



Sets often ship in multiple boxes and may arrive a day or two apart.

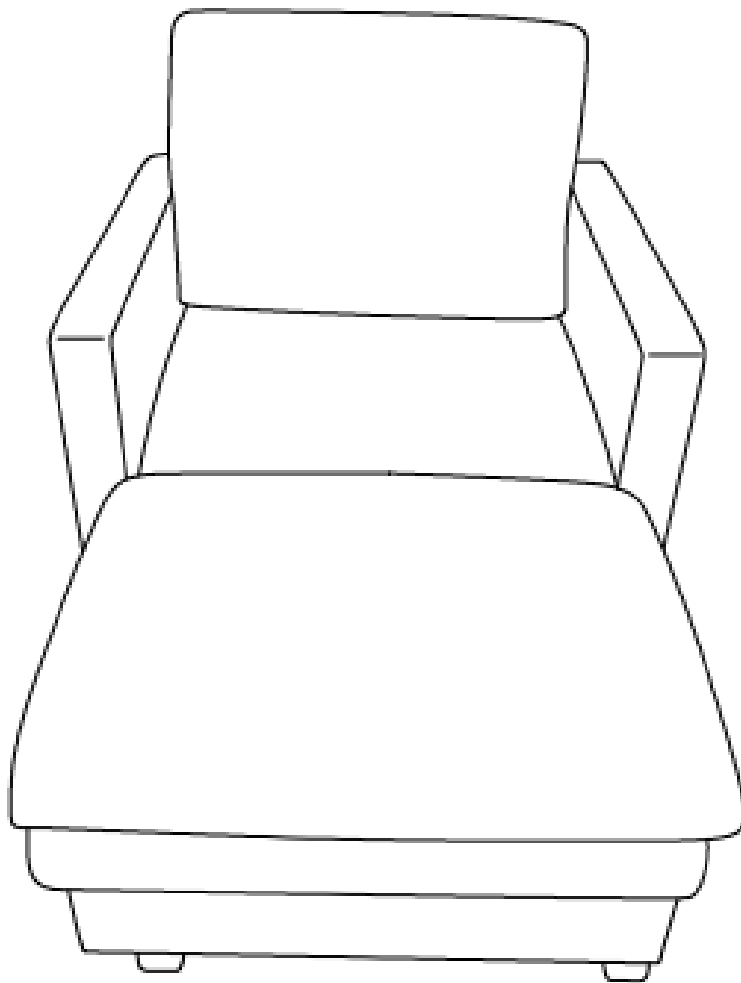



CHAIR  
N765P216174

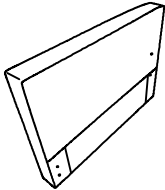
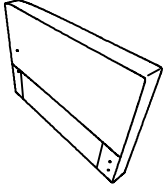
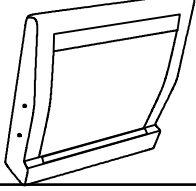
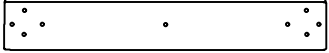
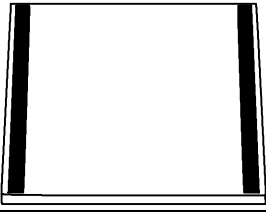

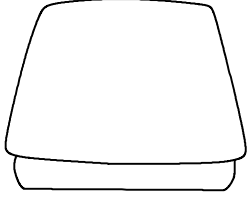
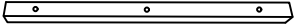
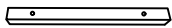

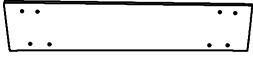

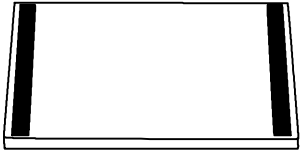
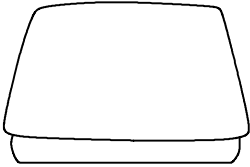



# Part List

N765P216174

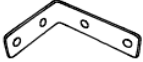
Label	Picture	Description	QTY
AL		Left armrest	1
AR		Right armrest	1
B		Backrest	1
C		Front bafflez	1
D		Seat frame	1
E		Backrest cushion	1
F		Seat cushion	1
G		Supporting block	1
H		Ottoman Supporting blocks	2

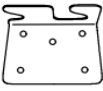
Label	Picture	Description	QTY
I		Ottoman front baffles	2
J		Ottoman Lateral baffles	2
K		Ottoman Seat frame	1
L		Ottoman seat cushion	1
M		Gaskets	8
N		Leg	8

### Hardware List

Label	Picture	Description	QTY
①		Conical connector	2
②		Conical connector	2
③		Leg iron	4
④		Bracing cage	4
⑤		Hook support iron	1
		Hook support iron	1
⑦		Screws M6X15mm	50
⑧		Screws M6X40mm	7
⑨		Hex key	1

# Assembly Preparation

Before Beginning Assembly:

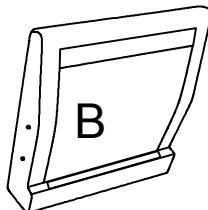
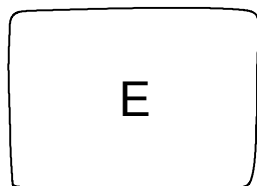

①\*2

②\*2

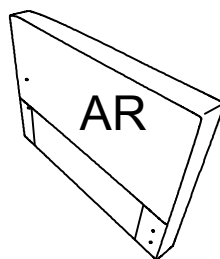
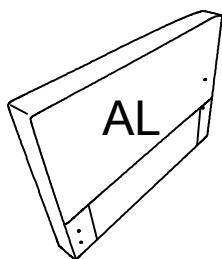

③\*4

④\*4

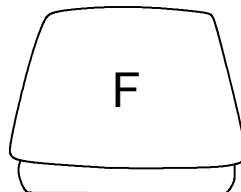
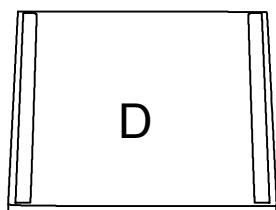

⑤\*1

⑥\*1

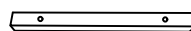
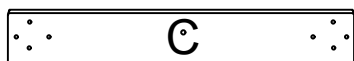

H\*2

↓  
⑦\*50  
M6\*15MM

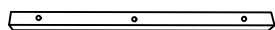

G



⑧\*7  
M6\*40MM

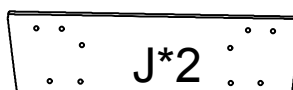

J\*2

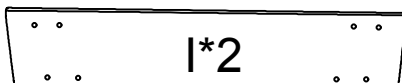

I\*2

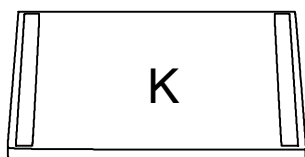

K

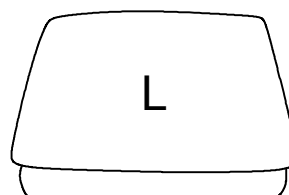

L



⑨



N\*8



M\*8



- Read instructions, cover to cover-



- Have 2 adults on hand for assembly-



- Do not assemble on flooring or carpet-



- Assemble on a clean non-marring surface (packing foam)-



- Save all packaging until finished-

## Assembly Steps

### OVERVIEW

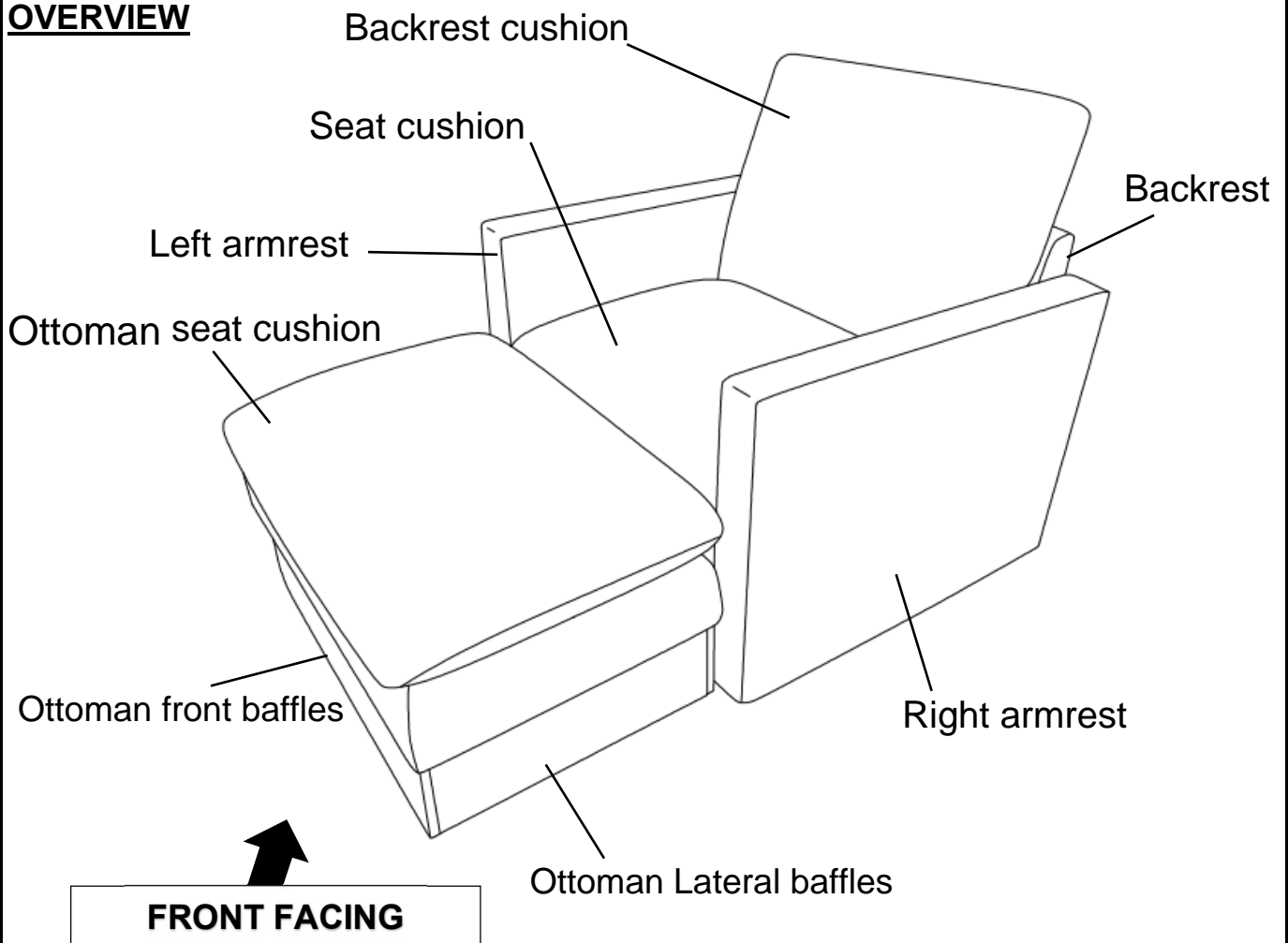

This Chair has multiple parts and may require up to 60 minutes to assemble. To give you an overview of the Chair parts, the above picture is to help you put the various parts into perspective. Please read through the instructions below to familiarise yourself with the parts and steps before assembly.

**Note: It is recommended that you have an adult partner to assist during the entire assembly process.**

### Step 1

① x2

⑦ x8

M x4

N x4

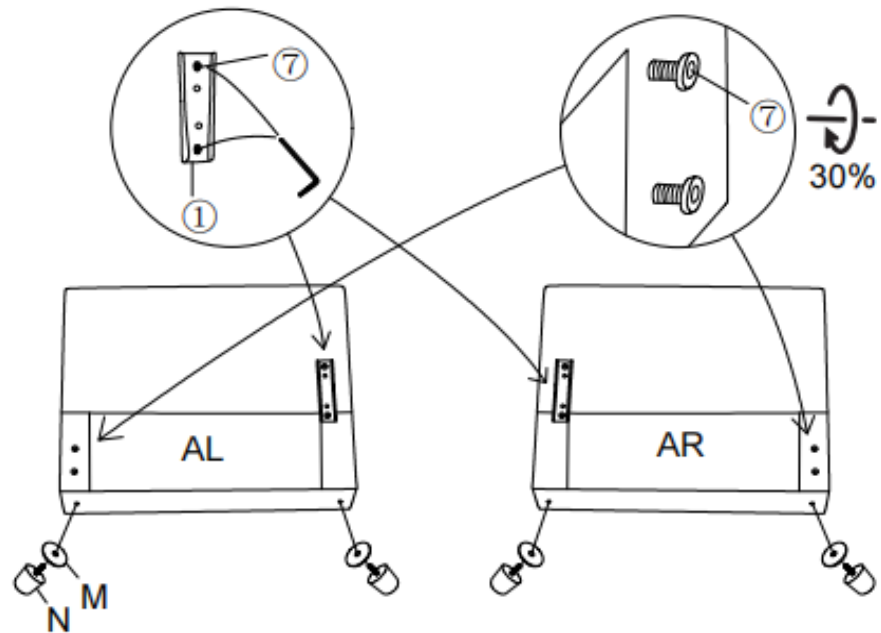

Use the wrench tool to secure part① to Left armrest AL and Right armrest AR with part⑦.  
Fasten the legs N through accessory M to Left armrest AL and Right armrest AR  
Use a wrench to loosen the two bolts of the left handrail (AL) about 1/2 cm.  
Repeat the same steps to loosen the 3 bolts of the right handrail (AR).

### Step 2

② x2

⑦ x4

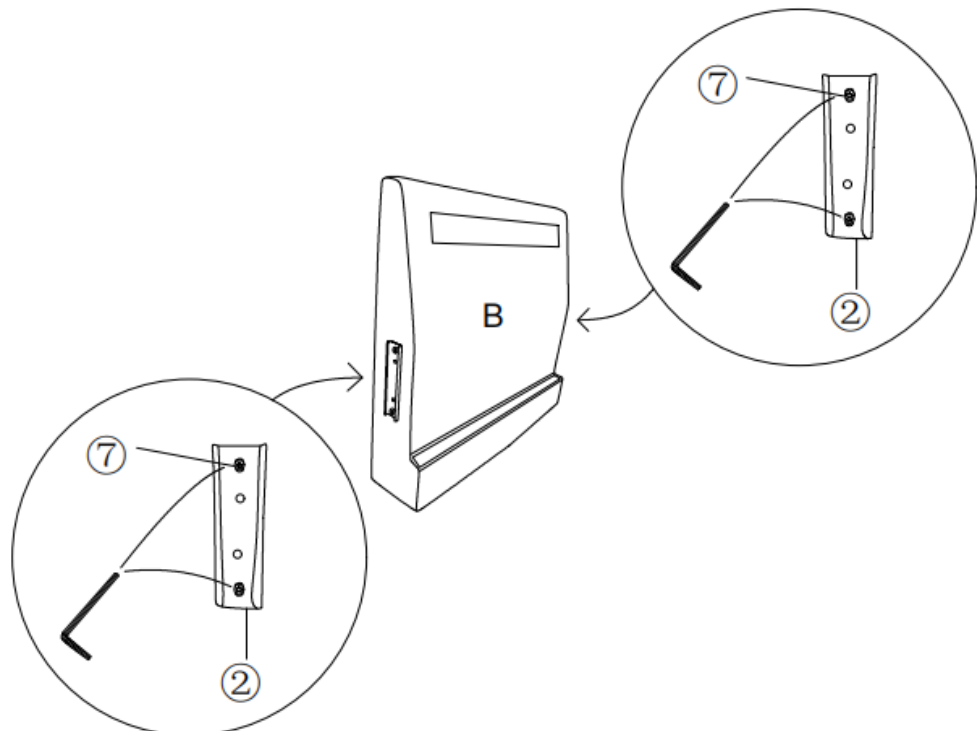

Use the wrench tool to secure part② to Backrest B with part⑦.

**Step 3**

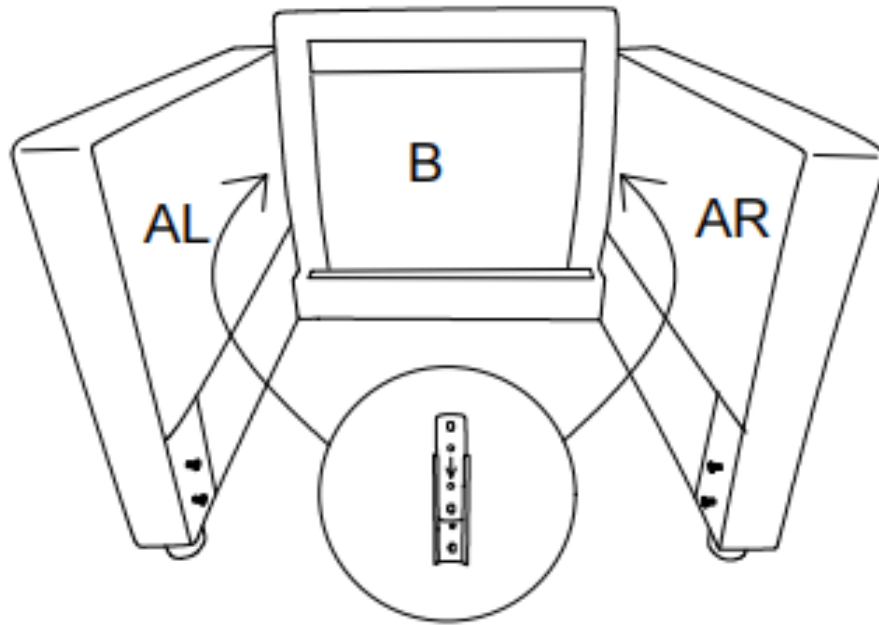

Slide the Tapered Connectors on the Backrest B into the Tapered Connectors on the Left Armrest AL and Right Armrest AR

**Note: Make sure the Tapered Connectors on the Backrest B into the Tapered Connectors on the Left Armrest AL and Right Armrest AR**

**Assistance from an adult partner is necessary for this assembly process.**

**During this assembly process - do exercise caution. You may need to use your hand to press**

**Caution: Ensure that your fingers do not get caught or pinched in the assembly process.**

**Step 4**

⑤ x 1

⑥ x 1

⑦ x 6

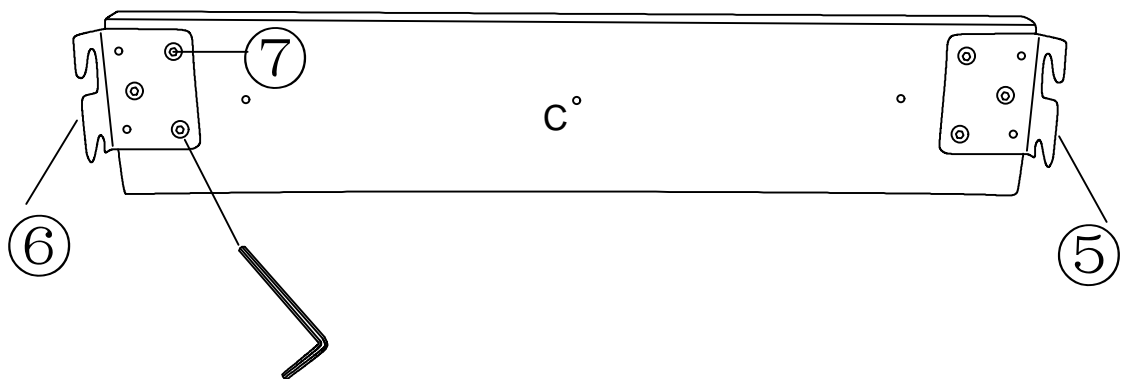

Use the wrench tool to secure part ⑤ and part ⑥ to Front baffle C with part ⑦.

Step 5

⑧ x 3

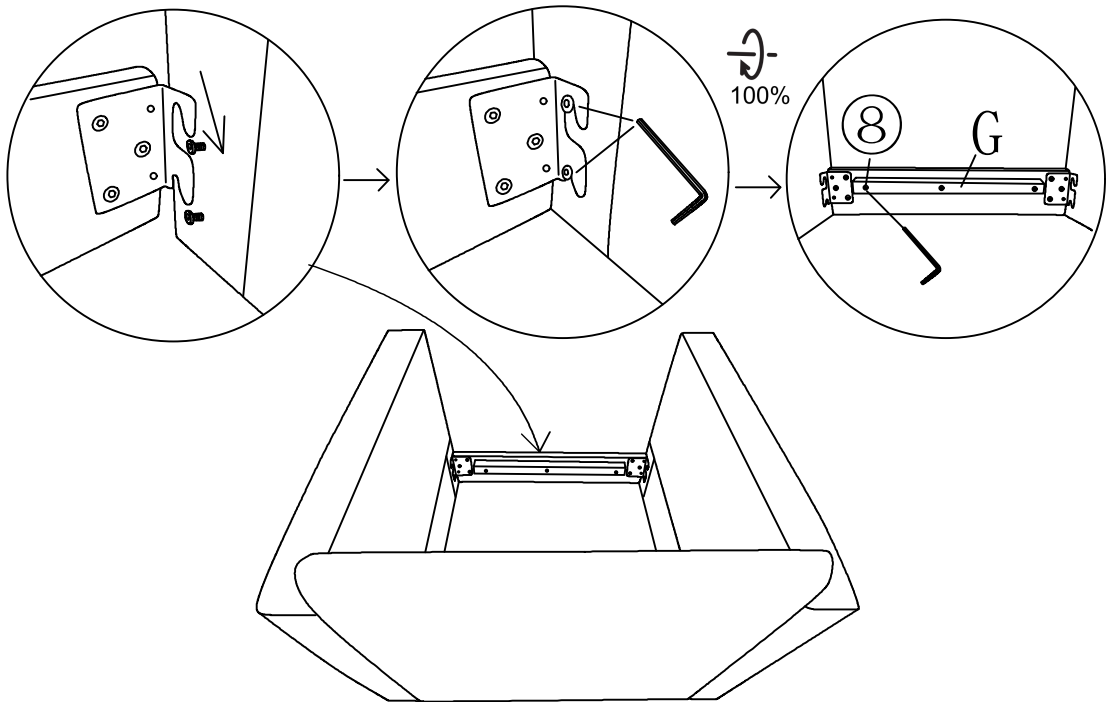

Fasten the connectors on the left and right sides of Front baffle C to the screws on the left armrest AL and right armrest AR with a wrench

Use the wrench tool to secure Supporting block G to Front baffle C with part ⑧.

Step 6

③ x 4

④ x 4

⑦ x 32

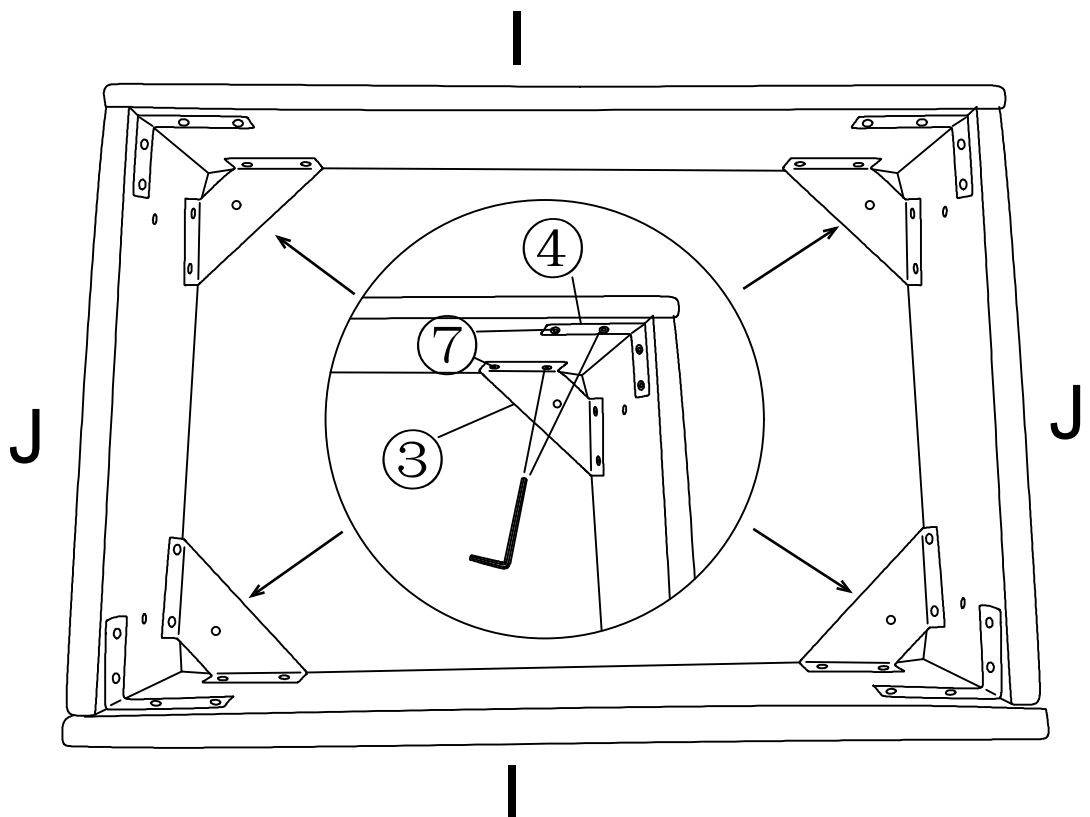

1. Use the wrench tool to secure part ④ to Ottoman front baffles I and Ottoman Lateral baffles J with part ⑦.
2. Use the wrench tool to secure part ③ to Ottoman front baffles I and Ottoman Lateral baffles J with part ⑦.

Please twist the part ③ screw to ~50%, twist the part ④ screw to ~50%, and then tighten the screws together

Step 7

⑧ x4

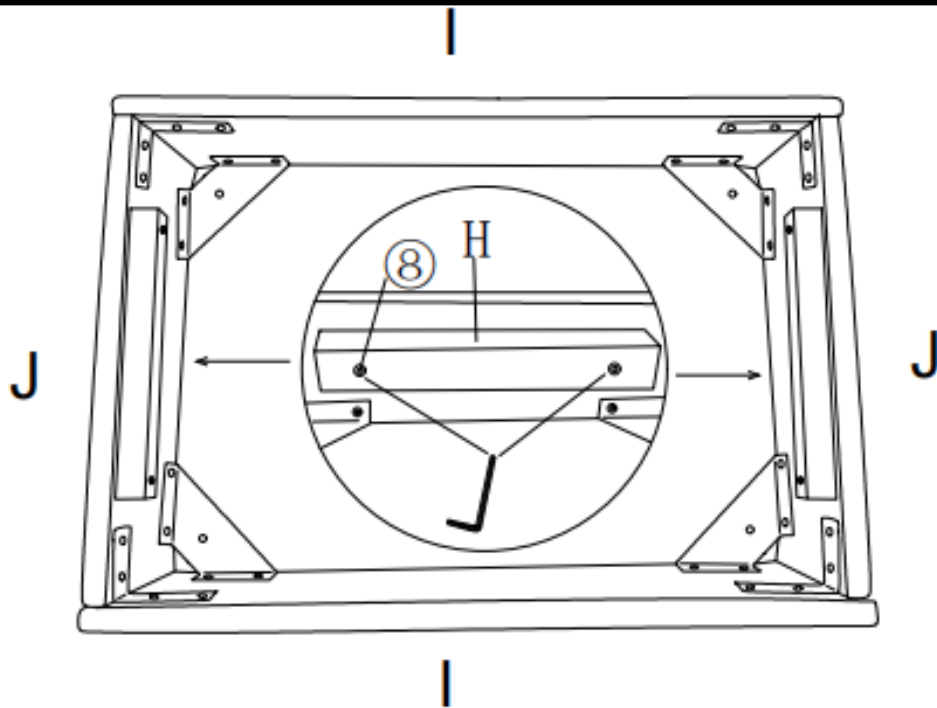

Use the wrench tool to secure Ottoman Supporting blocks H to Ottoman Lateral baffles J with part⑧.

Step 8

M x4

N x4

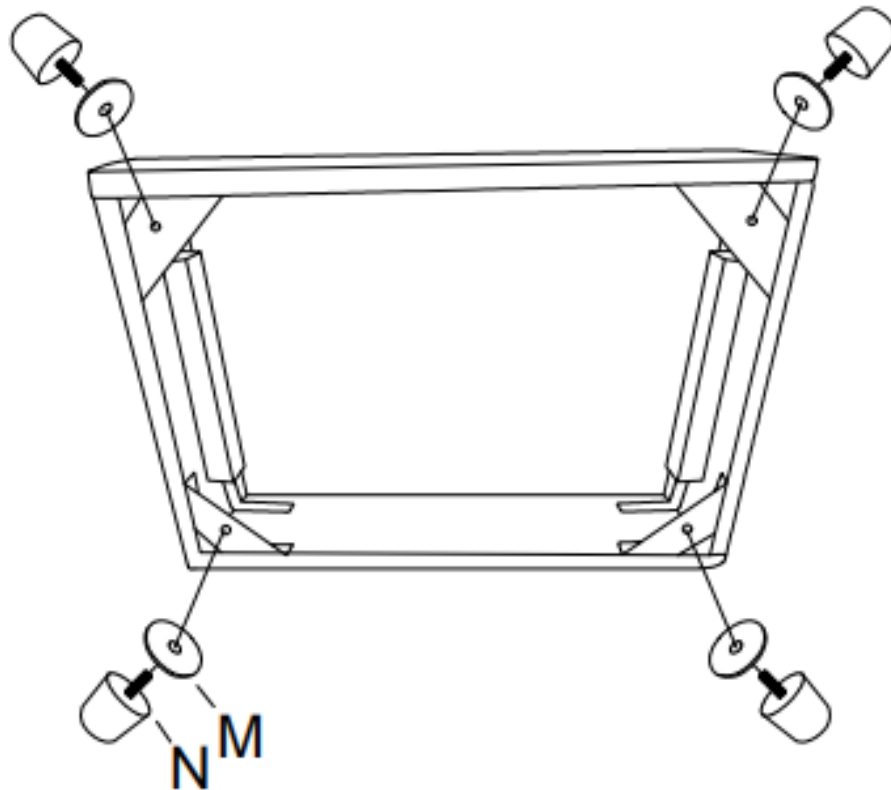

Fasten the legs N through accessory M to part③

Step 9

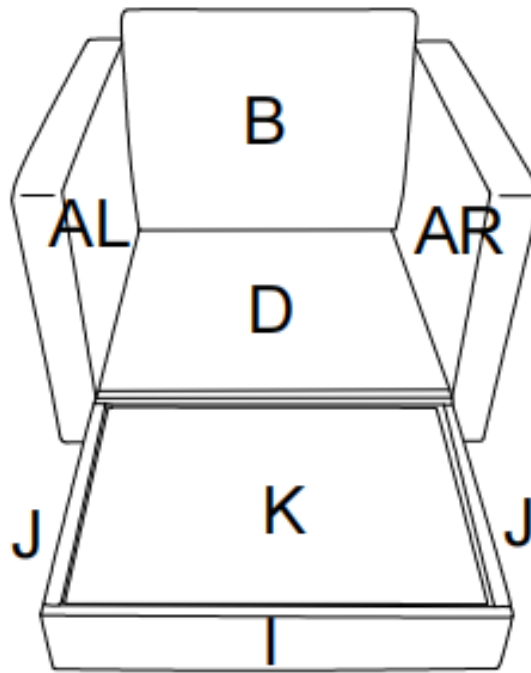

Step 10

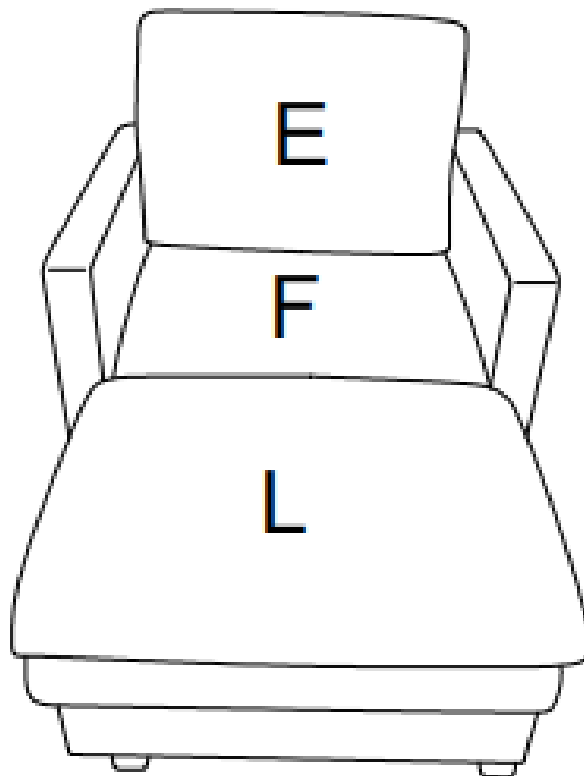

Step 11

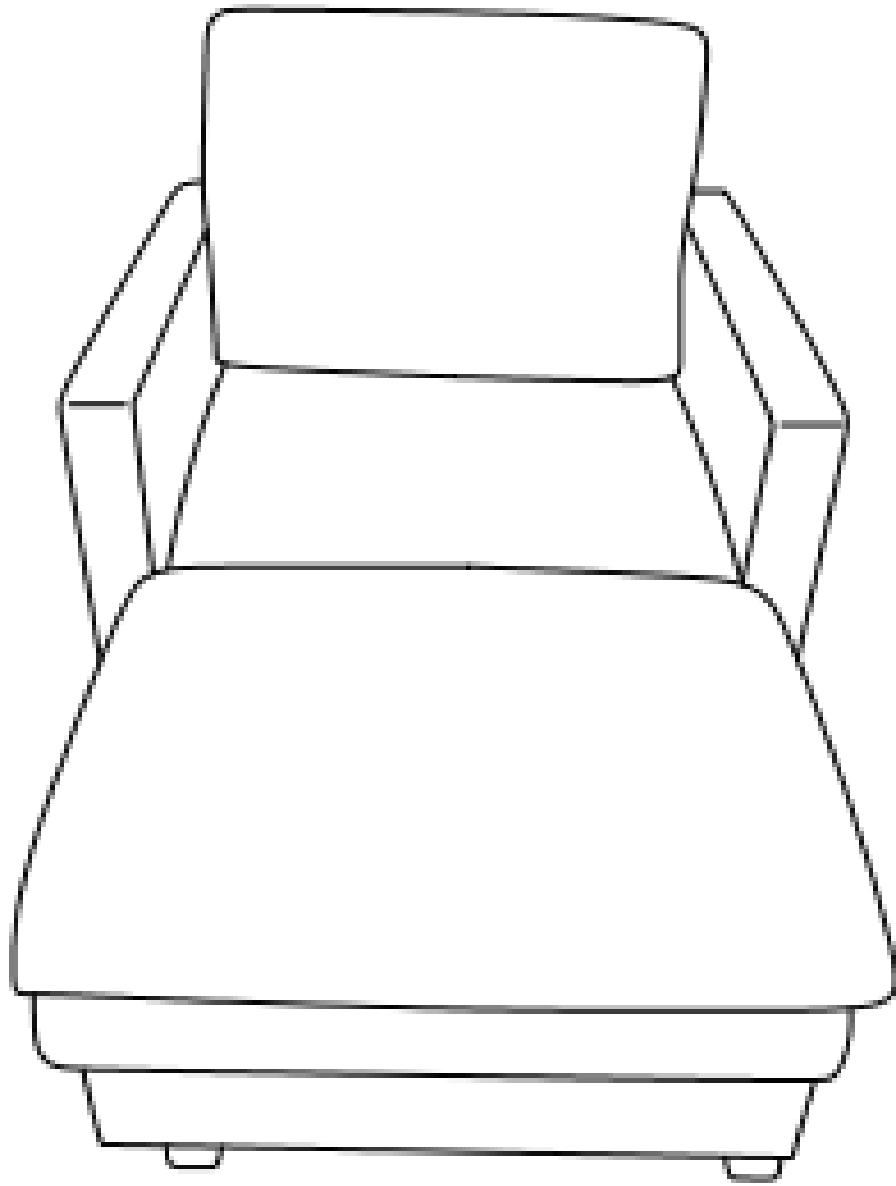

Your Chair is ready for use.  
This Chair can only be used on a flat, level surface.