

To deodorize the chair, leave it in a shaded and well-ventilated outdoor area for 1-2 days.

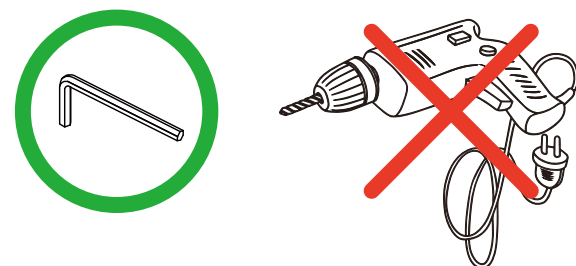

For long-term use, periodically retighten all bolts with the provided Allen Key.  
 Note: Do not use an electric screwdriver, as it may damage the chair. Always tighten the bolts manually.



## Safety Information



Sit in the center of the chair, with your back against the backrest.

Do not sit on the front edge of the chair.

Do not stand on the chair.

Do not use the chair with more than one person.



Do not push the chair around when a person is sitting in it.

Do not push down on the backrest when a person is reclined.

Do not put your full weight on the backrest.

# INSTRUCTION MANUAL

Model: FK-BYV2347

✉ HJ-Customer-Service@outlook.com

☎ (909)637-7665 | (909)637-7593

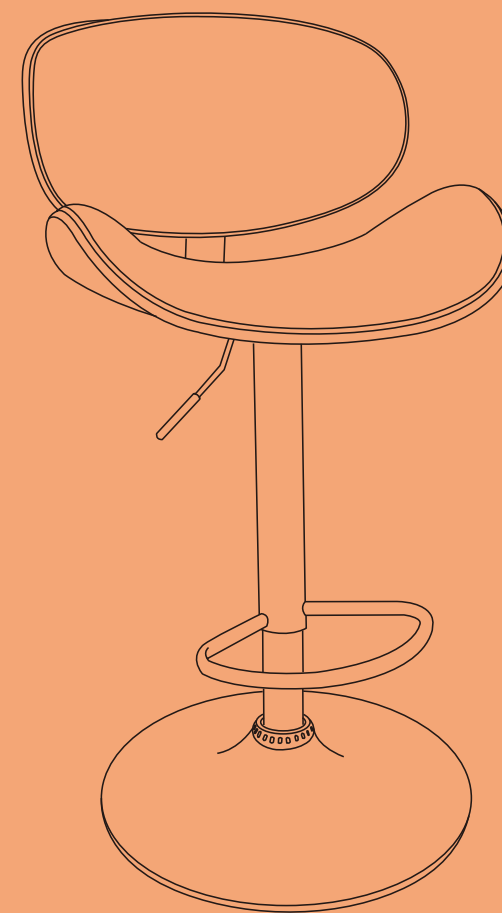

# INSTRUCTION MANUAL

## FK-BYV2347

✉ HJ-Customer-Service@outlook.com

☎ (909)637-7665 | (909)637-7593

EST 9:00AM--17:00PM



## Parts List

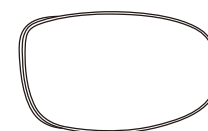

(A)\*1



(B)\*1

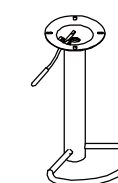

(C)\*1

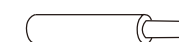

(D)\*1

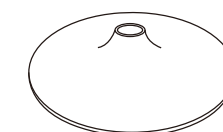

(E)\*1



(F)\*1

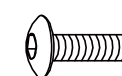

(1)\*4  
M6x16mm

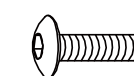

(2)\*7  
M6x20mm



(3)\*1

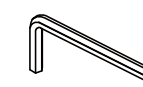

(4)\*1

# Assembly Instruction

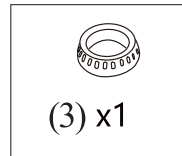
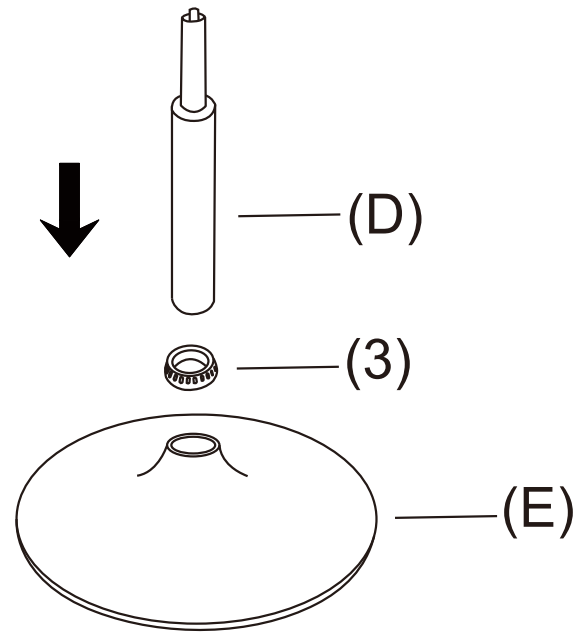
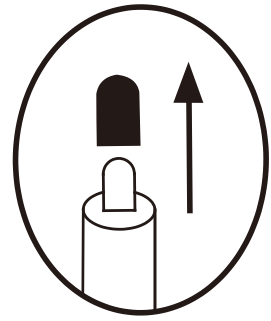

1

**NOTE:** Please remove black cap from top of Gas Lift (D) before assembly.

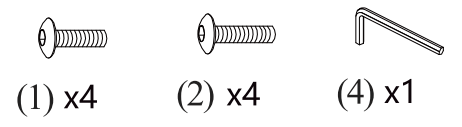
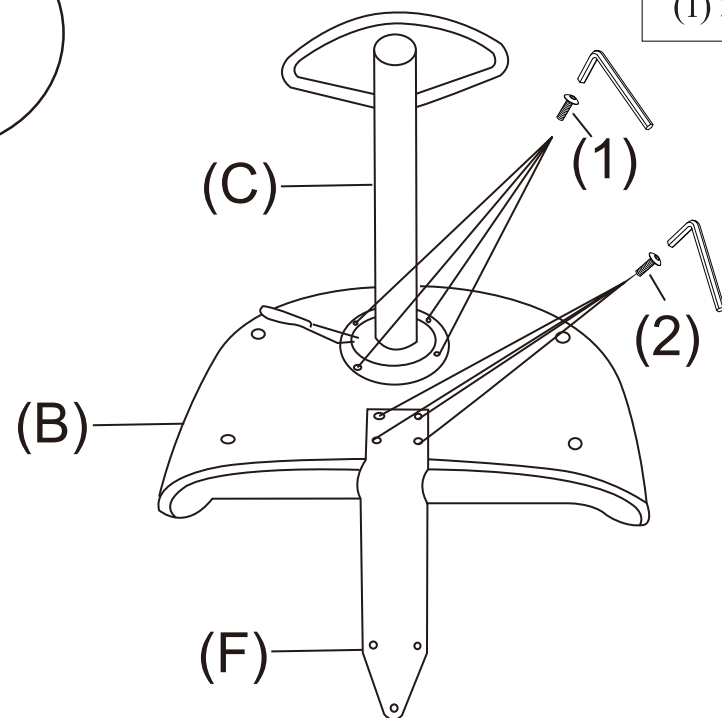
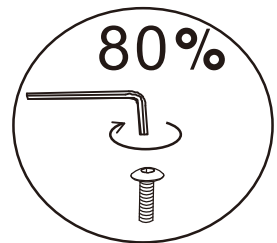

2

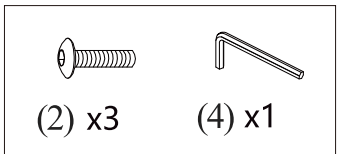
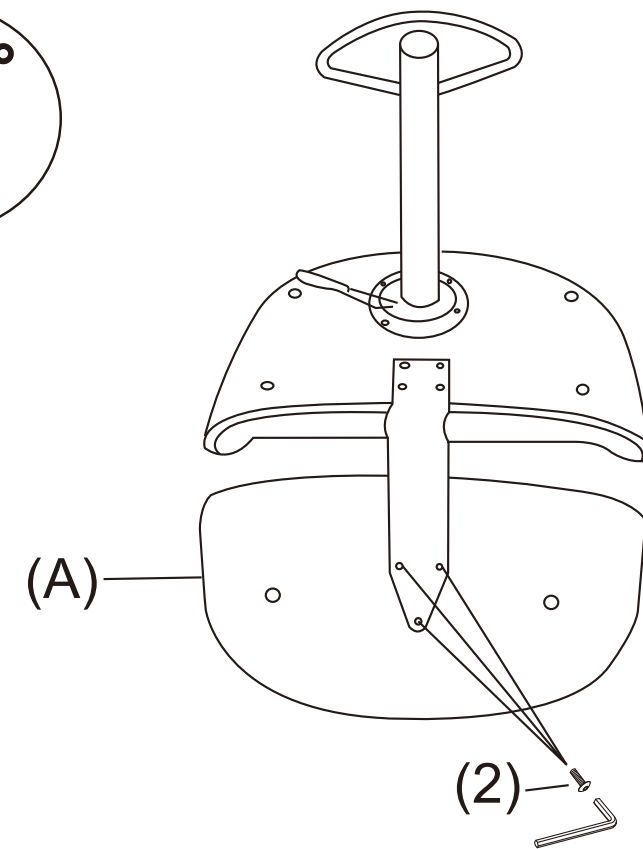
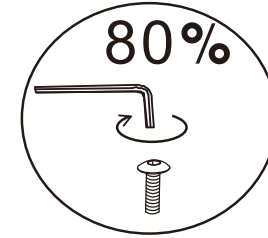

3

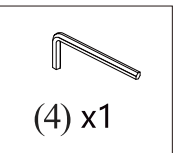
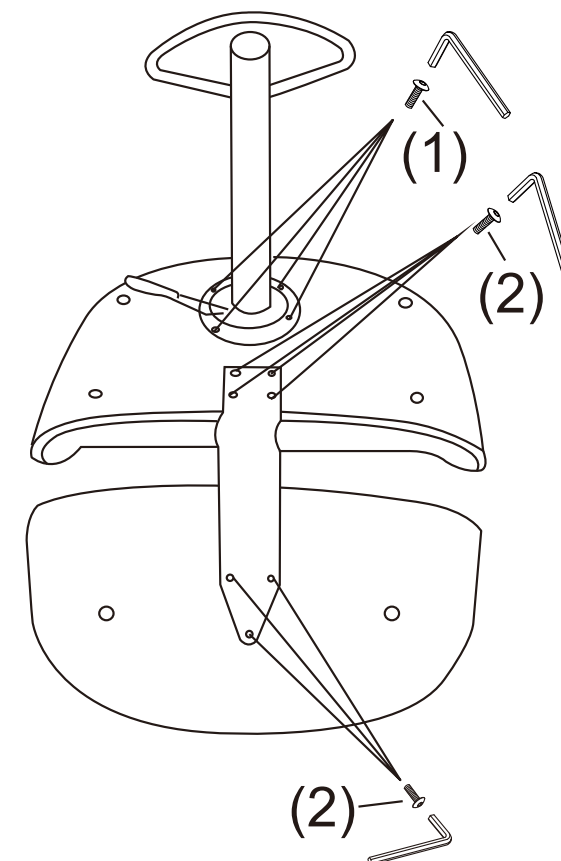
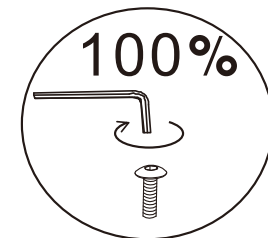

4

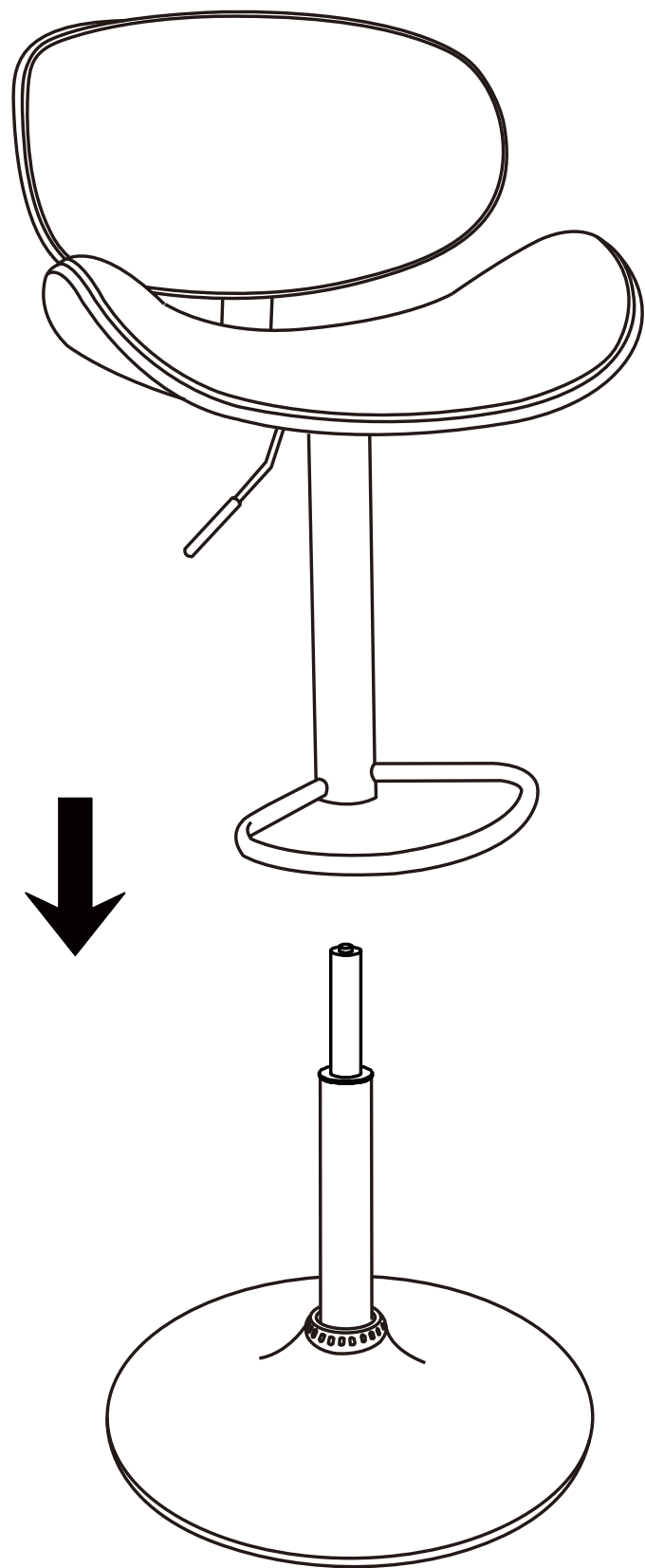

5

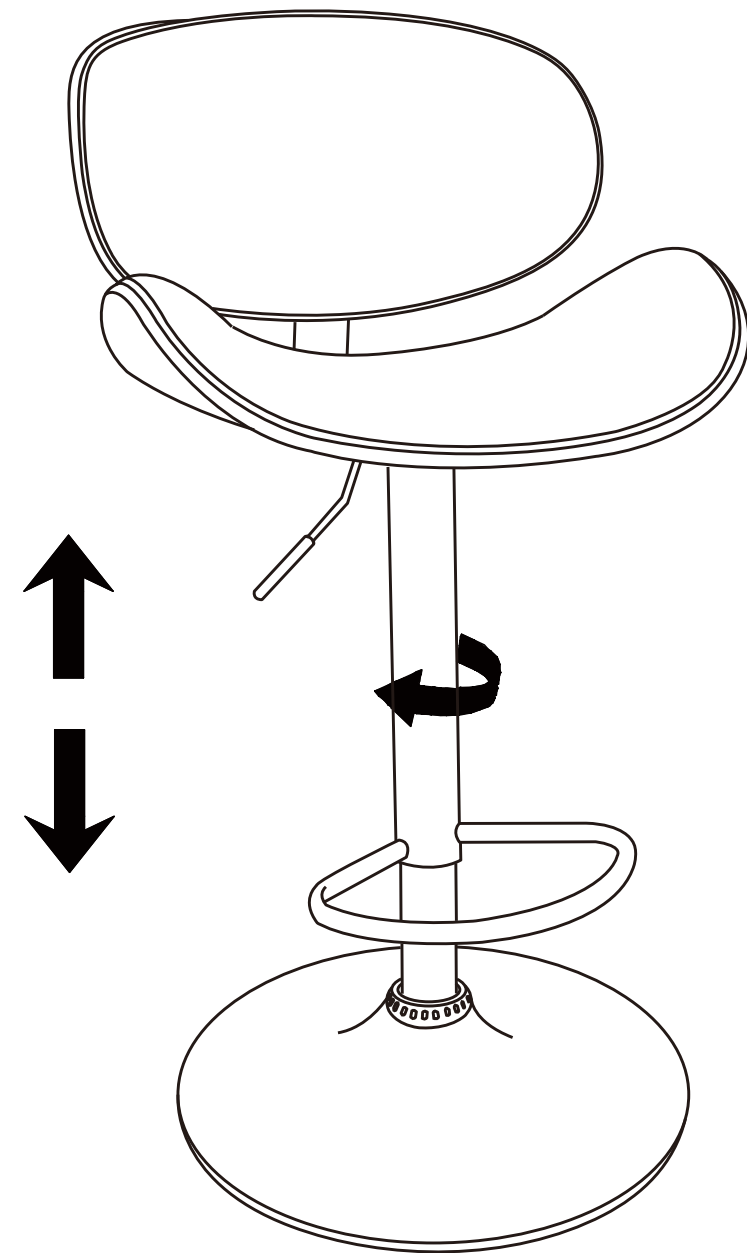

**6** **NOTE:** The height adjusts easily by pulling the handle up and down. And the seat of the Bar Stools can be rotated 360 degrees freely.

### CAUTION:

- \* Before using the Bar Stools, check to ensure that all bolts are fully tightened.
- \* Lubricate all parts and tighten all bolts every 6 months or whenever needed.

**NOTE:** Please ensure all bolts are 100% tightened.