

UNIQUE LIMITED LIFETIME WARRANTY

This warranty gives you specific legal rights, and you may also have other rights which vary from state to state.

WHAT IS COVERED

Except as specified below, the manufacturer of this product warrants it to be free of all defects in workmanship and material.

WHAT IS NOT COVERED BY THIS WARRANTY

1. All costs of removal or reinstallation of the fan.
2. Damage resulting from failure to follow instructions contained herein.
3. Damage occurring during shipment of the product (claims must be presented to the carrier).
4. Damage resulting from accident, misuse, abuse, or neglect.
5. Damage resulting from the application of any exterior coating, or by the addition of any unapproved accessories.
6. Damage resulting from repair or attempted repair by anyone other than the manufacturer.
7. Damage resulting from causes other than product defects, including lack of technical skill, competence, or experience of the user.

8. Glass or acrylic components or accessories.
9. Minor occurrences of 'wobble' are accepted as normal and should not necessarily be considered a defect.

WHO MAY ENFORCE WARRANTY

This warranty may be enforced only by the original purchaser. The end user must possess a dated proof of purchase from an authorized dealer to establish a warranty claim.

LENGTH OF THE WARRANTY

1. For the fan motor – for the lifetime of the original purchaser.
2. For everything else, except blades and finish - one year from the date of purchase.
3. For fan blades and finish - 90 days from the date of purchase.

WHAT WE WILL PAY FOR -

We agree to correct defects outlined in the warranty without charge, or at our option replace the fan with an equivalent

or superior product if the defective unit is returned prepaid to us.

TO GET WARRANTY SERVICE

To obtain warranty service, the product must be returned prepaid to . (This warranty is not enforceable outside the United States.) Details regarding return shipment are explained elsewhere in this manual. Whenever warranty service is required, **you must present a copy of the original dated sales receipt as proof of coverage.**

There is no other express warranty. Quorum hereby disclaims any and all implied warranties, including but not limited to those of merchantability or fitness for a particular purpose to the extent permitted by law. Quorum shall not be liable for incidental, consequential, or special damages arising out of or in connection with the product use or performance except as may otherwise be accorded by law. The duration of any implied warranty which cannot be disclaimed is limited to the periods specified above in the express warranty.

EXTENDED WARRANTY SERVICE

An extended warranty which applies to all parts except the fan motor (which is covered by the lifetime warranty) is available. This coverage allows free parts replacement for any such components for the lifetime of the original owner of the fan. Indicate your desire for this added coverage on the warranty reply card and mail, along with \$11.50 to Quorum. We will acknowledge your registration for this coverage.

WARRANTY SERVICE

1. Most problems can be handled by our customer service agents over the telephone. Customers seeking warranty repair or replacement for any fan or component are encouraged to call us for assistance. All returns must be issued a Return Goods Authorization number (RGA) prior to returning the defective unit or part. Call (817) 626-5483 - Monday thru Friday 8:00 a.m.-5:00 p.m. CST to obtain a RGA number.

2. Arriving shipments will be refused if they do not bear a valid RGA number on the outside packaging.

3. A dated proof of purchase must accompany any fan or component clearly indicating the name of the original purchaser.

4. To avoid damage in transit, the product should be returned in its original box and packaging. Quorum will not bear responsibility for any such damage.

5. Any return of a fan or component must be shipped freight and insurance prepaid.

FOR YOUR RECORDS

Purchases From _____
 City _____
 Fan Model No. _____
 Date Purchased _____

Complete and mail the enclosed warranty card within 10 days to ensure your warranty is registered.

If you have any questions regarding the warranty, or the procedures for obtaining service, please call us at (817) 626-5483 - Monday thru Friday 8:00 a.m.-5:00 p.m. CST.

CEILING FAN INSTALLATION INSTRUCTIONS

Please read and save these instructions

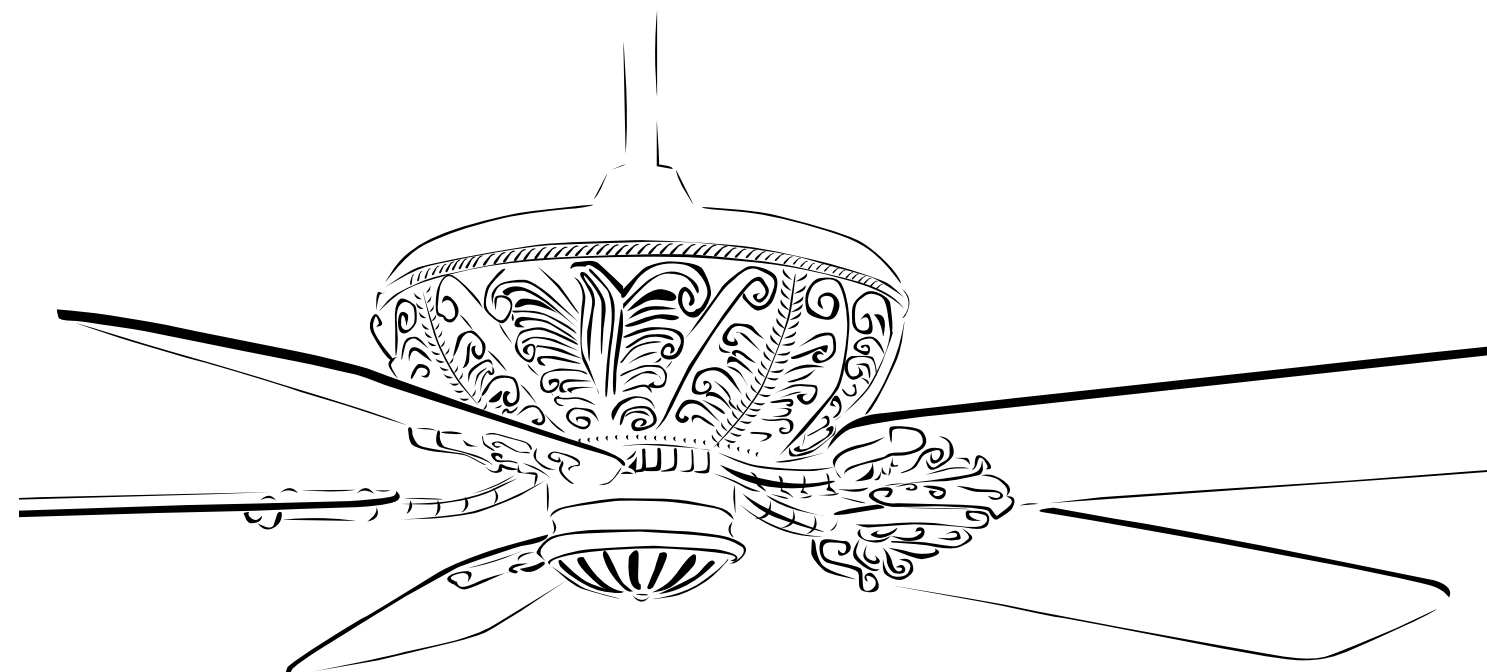

1. SAFETY RULES

19.5 lbs.

1. To avoid possible electric shock, **turn off the electricity** at the main fuse box or circuit panel before you begin the fan installation or before servicing the fan or installing accessories.

2. Read all instructions and safety information carefully before installing your fan and **save these instructions.**

3. Make sure all electrical connections comply with local codes or ordinances as well as the National Electrical Code. If you are unfamiliar with electric wiring, please use a qualified and licensed electrician.

4. Make sure you have a location selected for your fan which allows clear space for the blades to rotate, and at least

seven (7) feet of clearance between the floor and the fan blade tips.

5. The outlet box and ceiling support joist used must be securely mounted, and **capable of supporting at least 50 pounds.** To reduce the risk of fire, electric shock, or personal injury, use only an outlet box clearly labeled **“Acceptable For Fan Support”**.

6. To reduce the risk of personal injury use only approved hanging brackets and screws supplied with this fan for mounting to the outlet box.

7. After installation is complete, check that all connections are absolutely secure.

8. Do not insert anything into the fan blades while they are rotating.

9. Do not operate the reverse switch until the fan has come to a complete stop.

10. Do not attempt to control the operation of the fan (or an optional light kit) from any wall control that is not approved by Quorum for use with its fans. Do not use solid state wall controls. The use of an unapproved control voids the fan's warranty.

INSTALLATION TOOLS

Phillips Screwdriver
 Wire Cutters
 Electrical Tape
 Step Ladder

2. UNPACKING YOUR FAN

Unpack your fan and check the contents. Do not discard the carton. If warranty replacement or repair is ever necessary the fan should be returned in original packaging. Remove all parts and hardware. Do not lay motor housing on its side – the decorative casing may shift. Check all visible screws, bolts and nuts for tightness. Examine all parts. You should have the following:

1. Set of blades (a)
2. Fan motor assembly (b)
3. Hanger/mounting bracket (c)
4. Ceiling canopy (d)
5. Switch cup (e)
6. Yoke cover (f)
7. Set of blade arms (g)
8. Downrod assembly (4") and alternate downrod (6") (h)
9. Parts bags (i) containing:
 - Blade attachment hardware (screws with washer attached for each blade)
 - Bracket attachment hardware
 - Mounting hardware (wire nuts, 2" wood screws)

NOTE:

Some Quorum fan models will have slightly different parts than what is shown here depending upon the design you have chosen. Basic installation procedures are similar for all models.

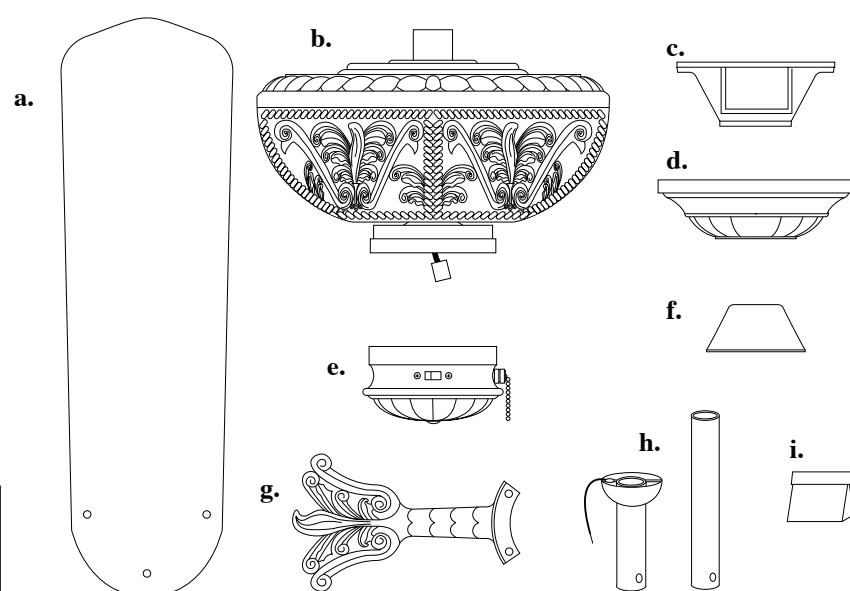

If you find that parts are missing, contact your dealer for replacement, or call Quorum directly and we will mail replacements to you immediately.

3. MOUNTING OPTIONS

WARNING - To reduce the risk of shock, fire or injury, mount the fan ONLY to an outlet marked "Acceptable for Fan Support".

1. Disconnect the power by removing fuses or turning off circuit breakers.
2. If there is an existing outlet box, ensure it is clearly marked "Suitable For Fan Support". If it is not so marked, it must be replaced with an approved one.
3. Secure the outlet box (or make sure the existing box is secured) directly to the building structure. Use appropriate fasteners and building materials.

Fig. 2

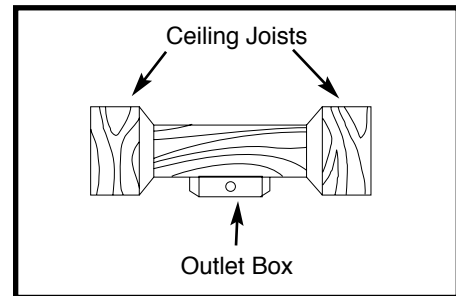

4. Figures 1, 2 and 3 are examples of different ways to mount the outlet box in different situations. A longer downrod may be required in sloped ceiling situations to maintain proper blade clearance.
5. To hang the fan in locations where no ceiling joist is available, a hanger support bar may be required (Fig. 4). Quorum distributes approved hanger support bars and outlet boxes.

Fig. 3

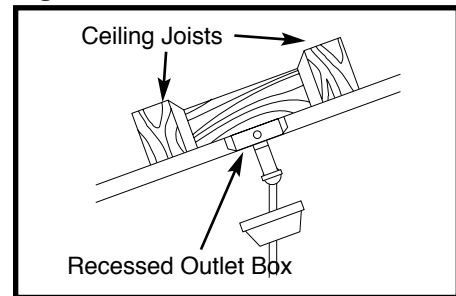

Fig. 1

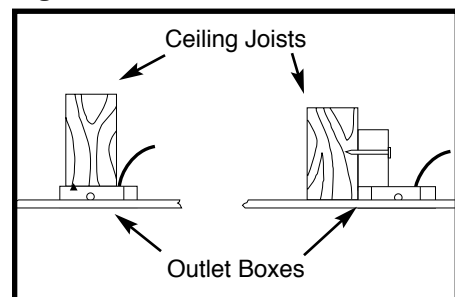
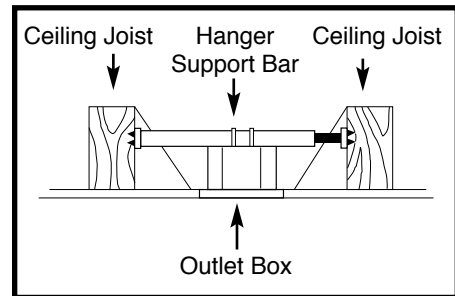

Fig. 4



4. HANGING YOUR FAN

WARNING - Turn off the power!

DO NOT fasten the blades to the fan until it is assembled and hanging from the ceiling. To do so now will likely bend the blade arms and almost certainly cause wobble.

1. If not already affixed to the hanger bracket, place the rectangular rubber isolators between the hanger bracket and outlet box. Secure the hanger bracket to the outlet box using the 2 long steel screws supplied with the fan.
2. Remove the set pin and safety lock clip from the downrod/ball assembly. Slide the downrod through the canopy. Slide the yoke cover onto the downrod (Fig. 5). Feed the wires from the fan motor through the downrod assembly.

3. (Fig. 6) Attach the downrod assembly to the motor by sliding the downrod into the yoke on top of the motor assembly. Slide the set pin through the hole in the yoke, downrod and washer and secure it with the safety lock clip. Tighten the set screws on yoke.
4. Lift the fan motor without the blades and place into the hanger bracket, rotating the ball until the groove engages the tab on the hanger bracket. This locks the ball mount and fan motor, preventing fan rotation during operation.

Fig. 5

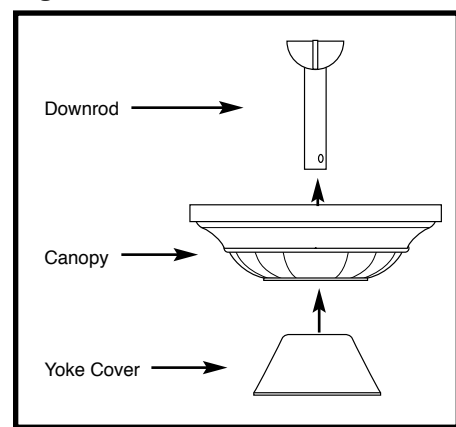
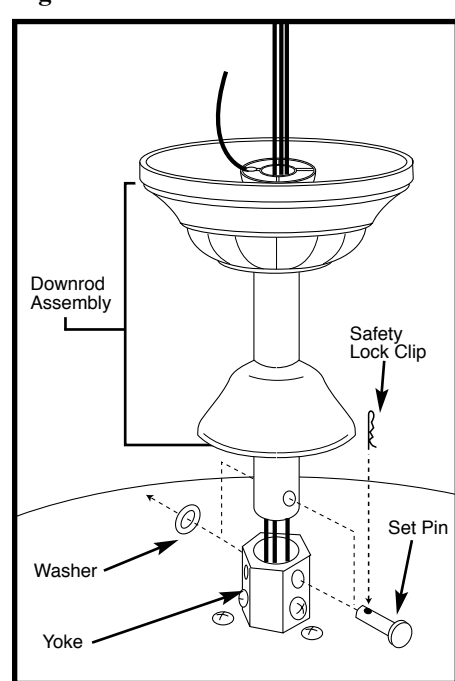

Fig. 6



5. ELECTRICAL CONNECTIONS

REMEMBER - Turn off the power!

Use the wires nuts supplied with your fan when making connections. Secure the connectors with electrical tape and make sure there are no loose connections or wire strands.

1. Spread the wires apart so that the black and blue wires from the fan are on one side of the mounting bracket and the white wire and green ground wire are on the other side.
2. (Fig. 7) Connect the BLACK building supply wire to the BLACK AND BLUE fan wires. Connect the WHITE building neutral wire to the WHITE fan neutral wire. Connect the COPPER building ground wire to the GREEN fan ground wire.

Fig. 7

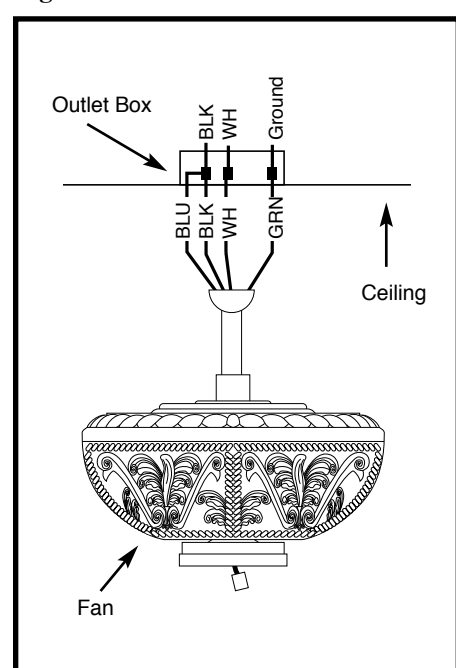

Fig. 8

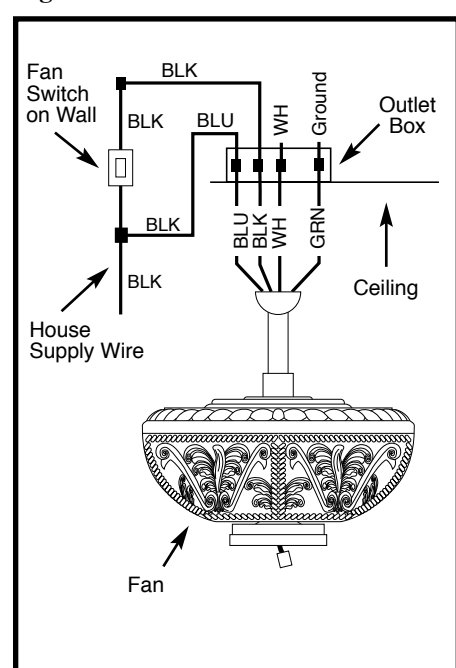
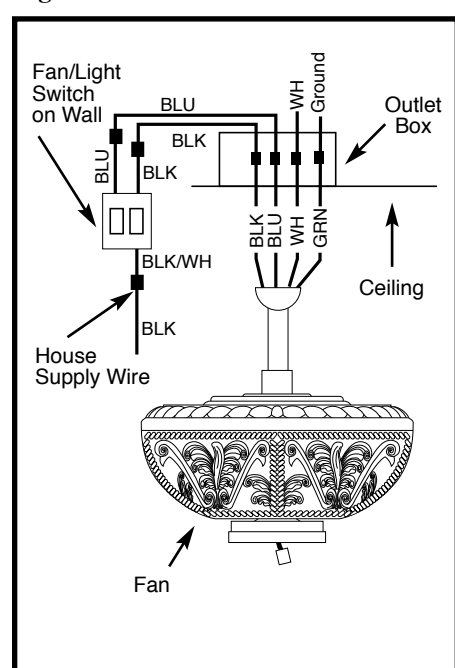

Fig. 9



3. **Optional Wall Controls**
Wiring connections for optional wall control are shown in Fig. 8 and 9. Figure 9 shows how to wire a fan wall control switch. This controls the fan only. To separately control an optional light kit using the light kit pull chain, you would have to connect the blue wire from the fan to the house supply wire, before it goes to the wall control. This is not an easy connection, and we suggest you call a qualified electrician to do it for you.

4. Inside the ceiling junction box be sure to spread the wires apart so that the black and blue connections are on one side of the outlet box and the white/white and green/copper connections are on the other side.

Use ONLY wall controls approved by Quorum. Use of unapproved wall controls will cause unacceptable humming noise, and voids the fan warranty.

6. COMPLETING THE INSTALLATION

1. Make sure the wiring is safely inside the outlet box as instructed in Step 5 - Electrical Connections. To install the canopy, partially unscrew the 2 screws in the hanger bracket. Align the slotted holes in the canopy with the screws in hanger bracket. Push up the canopy so the screws slip into the slot. Turn the canopy so it locks in place. Make sure the canopy is not quite touching the ceiling.

2. Blade Assembly

Using the supplied blade arm screws, attach the blades to the blade arms. (Fig. 10). In some cases the metal washer is permanently fixed to the screw head. Ensure all screws are used for each blade.

3. Blade Installation

You can provide easy access to the blade screw holes on the motor housing by centering them in the access hole of the flange. Attach the blades to the motor housing using the supplied screws. Turn the housing to expose the next set of blade screw holes. Continue with each blade. **DO NOT bend the blade arms when installing the blades.**

4. A certain amount of wobble may be considered normal, especially if the fan is on a downrod longer than 12".
5. (Fig. 11) Attach the switch cup by lining up the cannon plug from the motor housing to the one from the switch cup. Attach the switch cup to the flange with the screws provided.

6. Turn on the fan and check the 4 position speed switch - 3 speeds and stop. (Fig. 12) Check the reverse switch NOTE: Wait for the fan to stop rotating before changing from forward to reverse.

Fig. 10

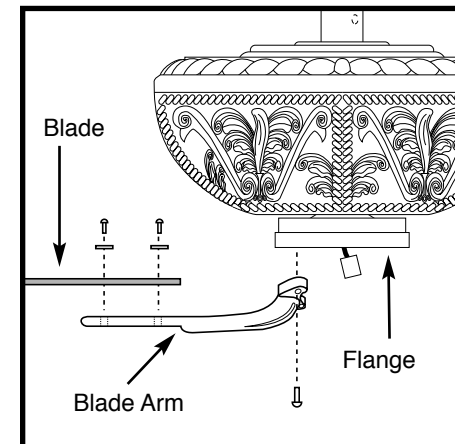

Fig. 11

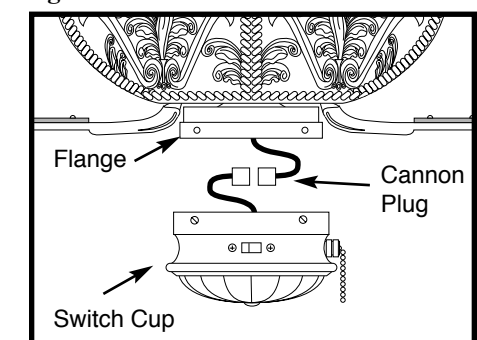
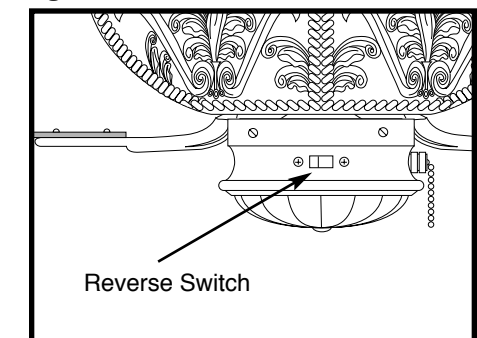

Fig. 12



7. FAN OPERATION AND CARE

1. A ceiling fan is an environmentally smart choice to cool as well as help to warm your home or office. You should see a reduction in both heating and cooling costs by regular use of your fan.

Do not hesitate to use your fan during summer and winter months. In summer, using the reverse switch, adjust the fan's direction so cool air is blown down, producing a cooling breeze. (Fig. 13) In winter, reverse the fan so that an upward airflow will push warm air off the ceiling and circulate it downwards into the living area (Fig. 14). In winter months, use the fan at a lower speed than summer.

2. Periodically check tightness of all screws securing the blades to the blade arm attachment points. A clicking or rattling noise is a sure indication of loosening screws. Since screws will invariably work loose over time, at least once a year, tighten all the screws attaching blades to blade arms. **Do not bend blade arms when cleaning or servicing the fan.**

3. Clean your fan periodically using only a cloth dampened with a mild detergent solution for all hardware - never use solvents. The finish plating is lacquered to prevent tarnishing. Use a lint-free cloth with clean water to clean blades.

4. You will never need to oil or lubricate your fan. Its permanently sealed bearings will provide trouble-free, silent operation for many years.

5. If repairs or servicing are ever required, to avoid possible electric shock, **turn off the electricity** at the main fuse or circuit panel before you begin.

Fig. 13

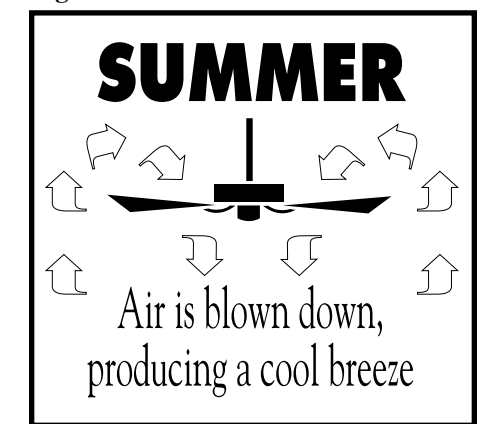
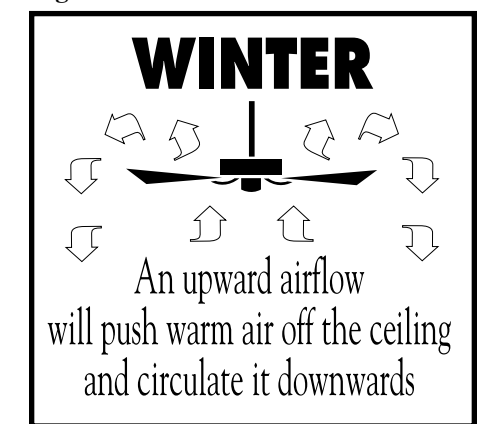

Fig. 14



8. TROUBLESHOOTING

FAN WILL NOT START

1. Check that the electricity has been turned on at the circuit breaker which had probably been turned off during installation.
2. Turn off the electricity. Check all connections in the wiring of the fan at the ceiling and make sure it follows the wiring instructions outlined in this manual.

NOISE

Note: Always allow a day or two "run-in" time for any new fan at medium or high speed. When attempting to diagnose noise, listen carefully from several sides to try and isolate the location of the noise (blades, upper end, motor, light kit, etc.).

1. Tighten all screws attaching blades to blade arms. Remember to tighten these screws at least once a year because they may loosen slowly over time and cause a clicking noise.

2. Turn off the power. Loosen the canopy and check that the wiring and/or wire nut connectors are not resting against the canopy, possibly vibrating while the fan is on.

3. Use of a standard light rheostat or an unapproved fan wall control to control the fan speed will always cause an annoying "hum". Many fan motors do not work quietly with solid state variable speed controls.

4. Check that the rubber gasket on the mounting bracket has been installed if called for in the installation instructions.

5. Check that the canopy is not touching the ceiling.

6. Check that all screws on the motor housing and the bottom housing are tight.

FAN TURNS, BUT DOES NOT MOVE MUCH AIR

1. The fan may be running in reverse.
2. The distance from the ceiling to the blades may be too small. At least 8" are recommended.
3. The room may contain items which obstruct the air flow.
4. The fan may be too small for the size of the room.

EXCESSIVE WOBBLE

Note: A small amount of wobble is considered acceptable and should not be considered a defect.

1. Make certain all blades are tightly attached to each blades' respective blade arm.

REPLACEMENT PARTS

For replacement parts, contact your local dealer.