

**ASSEMBLY AND CARE
INSTRUCTION**
Corner Shelf

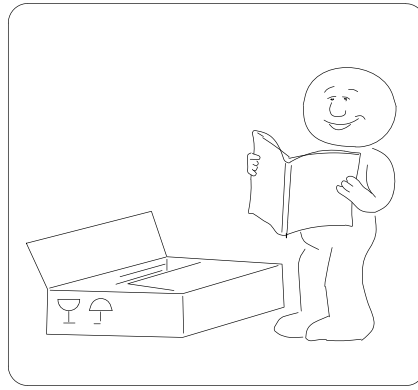

! WARNING !

1. PLEASE READ ALL INSTRUCTIONS CAREFULLY BEFORE STARTING ASSEMBLY.
2. DO NOT LET ANY SHARP OBJECTS TOUCH OR RUB THE SURFACE OF THE PRODUCT.
3. WHEN ASSEMBLING, DO NOT LET CHILDREN PLAY AROUND THE WORKING AREA.
4. PLEASE CONFIRM ALL PARTS ARE CORRECT BEFORE STARTING THE ASSEMBLY PROCESS.
5. DO NOT TIGHTEN ALL BOLTS AND SCREWS COMPLETELY UNTIL THE ENTIRE UNIT HAS BEEN ASSEMBLED AND SET UP.

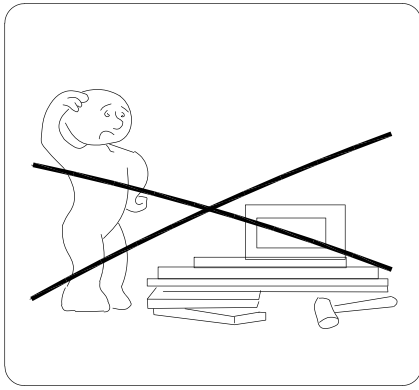
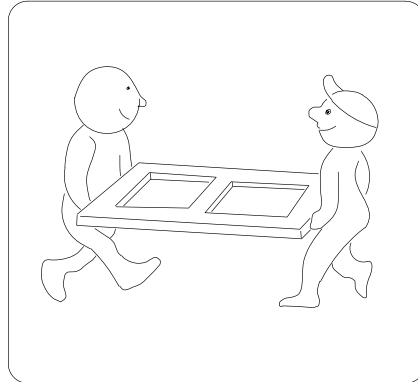
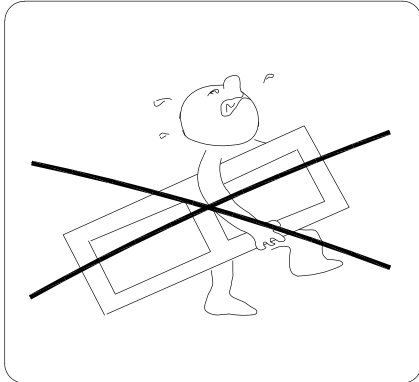
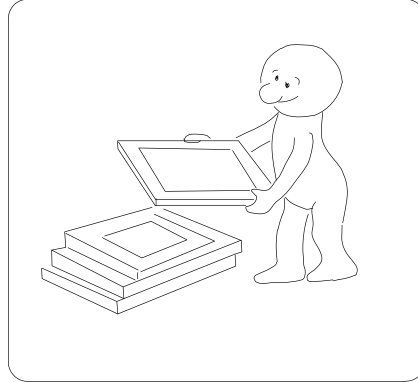
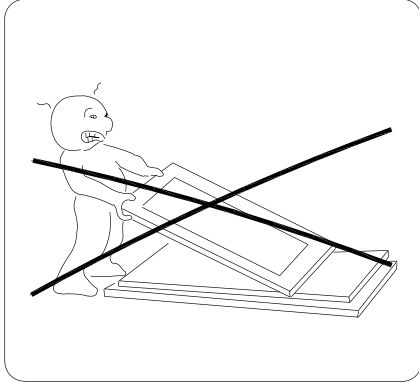

ADVISE

1. DO NOT SIT OR STAND ON THIS PRODUCT. IT IS INTENDED FOR PETS ONLY.
2. THIS PRODUCT SHOULD BE ASSEMBLED BY AN ADULT.
3. PLEASE PUT THE PRODUCT ON A SMOOTH SURFACE AFTER YOU ASSEMBLED IT.
4. PLACE ALL PARTS ON A CLEAN AND SMOOTH SURFACE SUCH AS A RUG OR CARPET TO AVOID THE PARTS FROM BEING SCRATCHED.
5. THE SCREW OF HINGE ON THE DOOR ALSO CAN BE ADJUSTABLE, TO MAKE IT EVEN THEN TIGHTEN ALL SCREWS.

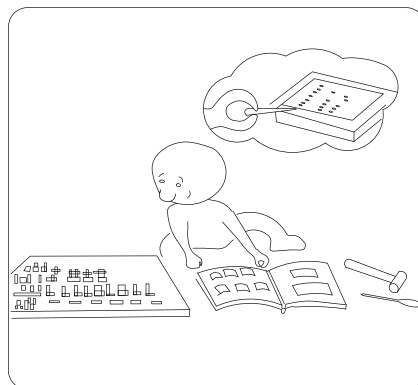
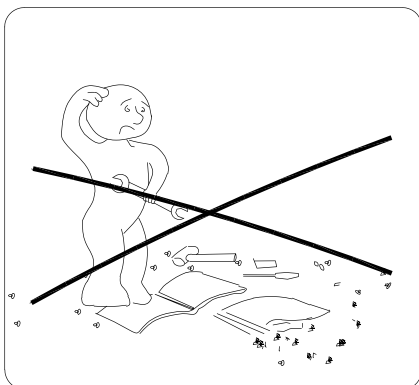

TOOL NEEDED

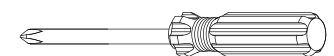

**SCREWDRIVER REQUIRED
- NOT INCLUDED**

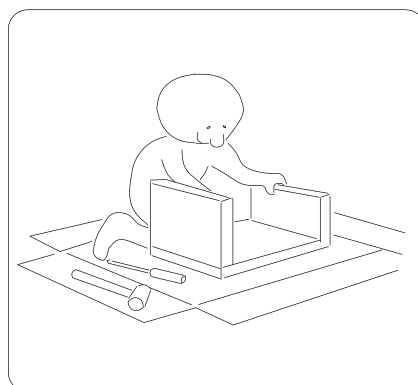
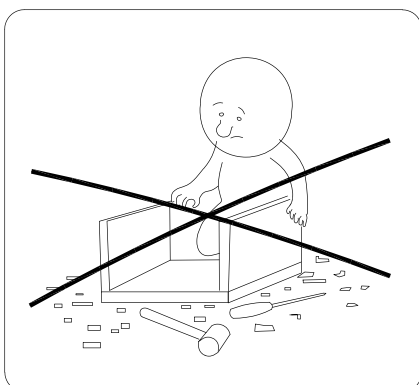

PARTS

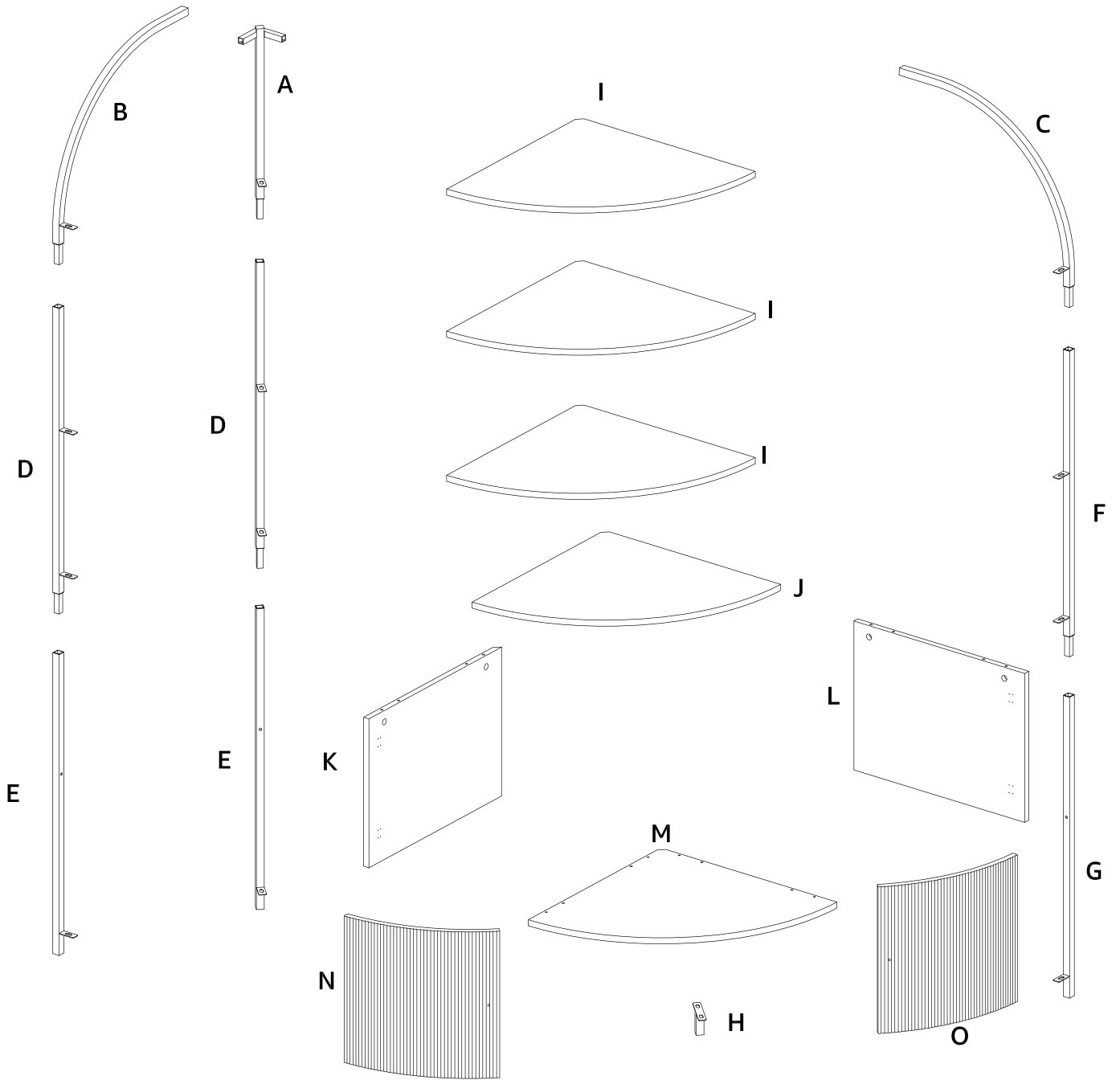

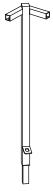

A
Iron Tube
x1



B
Iron Tube
x1

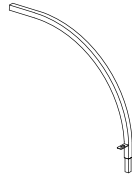

C
Iron Tube
x1



D
Iron Tube
x2



E
Iron Tube
x2



F
Iron Tube
x1



G
Iron Tube
x1



H
Support Feet
x1



I
Shelf
x3



J
Top Panel Of Cabinet
x1

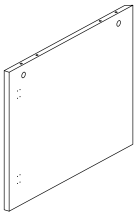

K
Left-Side Panel
x1

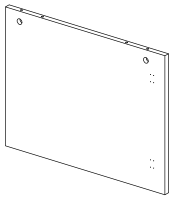

L
Right-Side Panel
x1



M
Bottom Panel
of Cabinet
x1

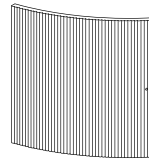

N
Left Door
x1

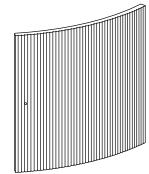

O
Right Door
x1

HARDWARE

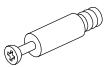

1
x 4 pcs



2
x 8 pcs



3
x 4 pcs



4
x 30 pcs



5
x 4 pcs



6
x 3 pcs



7
x 2 pcs



8
x 1 pc

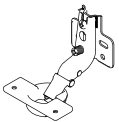

9
x 4 pcs



10
x 24 pcs



11
x 2 pcs



12
x 2 pcs



13
x 2 pcs



14
x 2 pcs



15
x 2 pcs



16
x 2 pcs



17
x 1 pc

ASSEMBLY INSTRUCTIONS



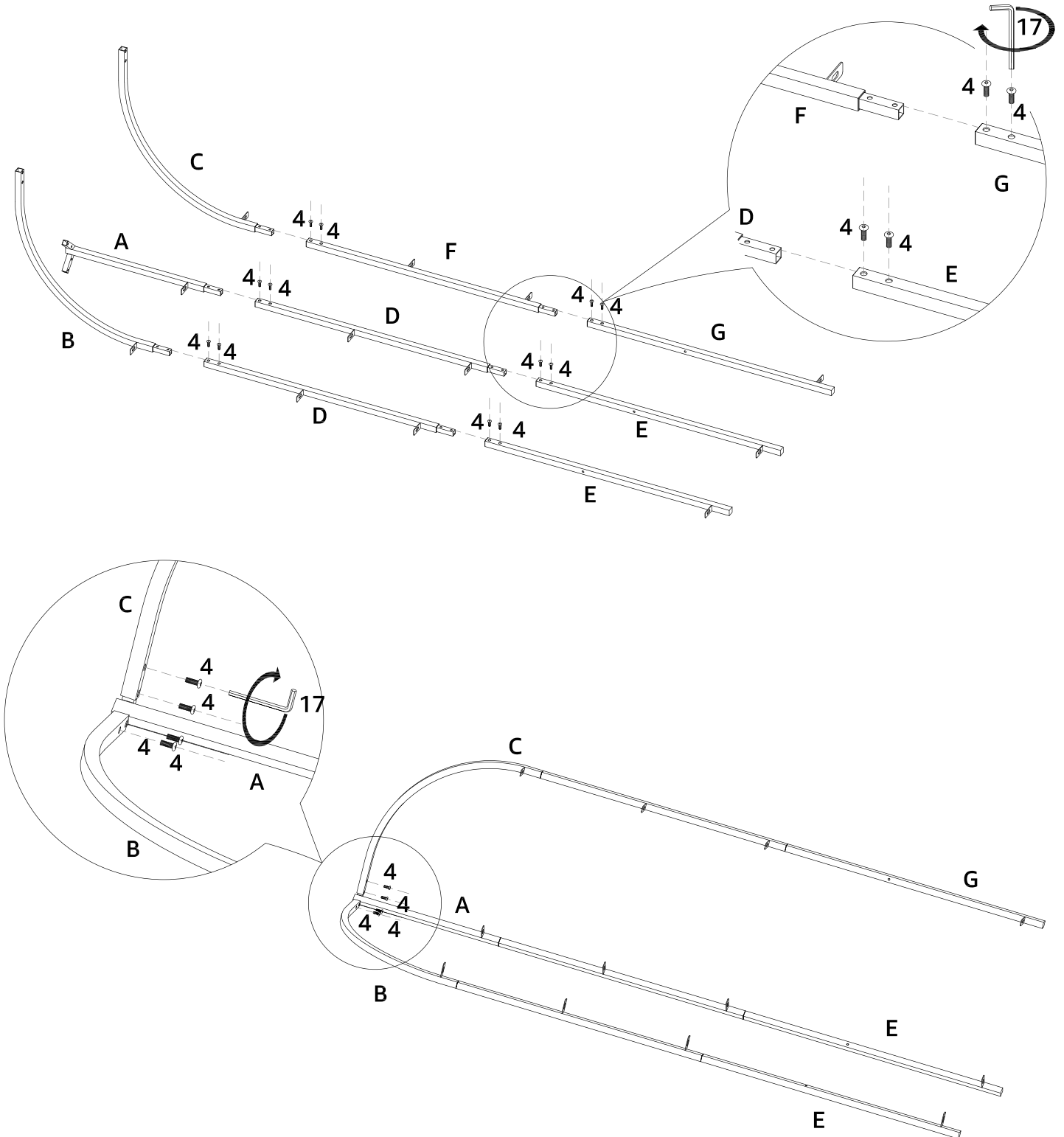
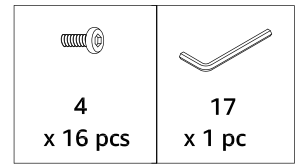





- 1 Insert Iron Tube A、 B、 C into Iron Tube D、 F and fasten it with bolt 4 by Allen Wrench 17. Insert Iron Tube D、 F into Iron Tube E、 G and fasten it with bolt 4 by Allen Wrench 17. connect assembled left、 right Iron poles to middle iron pole with bolt 4.

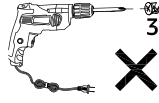

2

Insert pin 1 and wooden dowel 2 into Top Panel J of cabinet, Tighten magnet 8 to Top Panel J with screw 7.

Tighten Left-Side Panel L, Right-Side Panel K to Top Panel J with combiner 3.

 1 x 4 pcs	 2 x 4 pcs	 3 x 4 pcs	 7 x 2 pcs	 8 x 1 pc	  NO!	  YES!
---	---	---	---	---	--	---

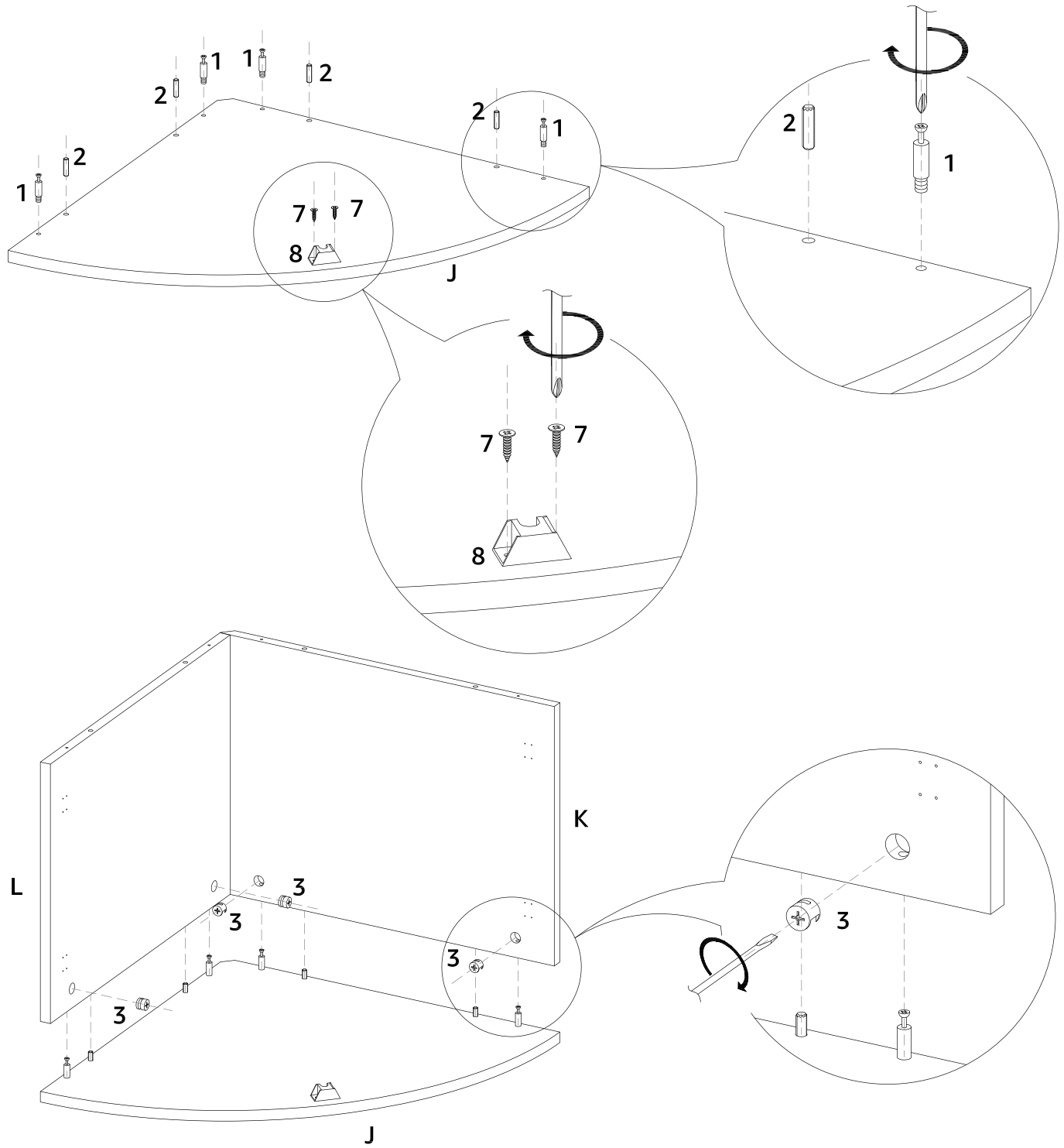

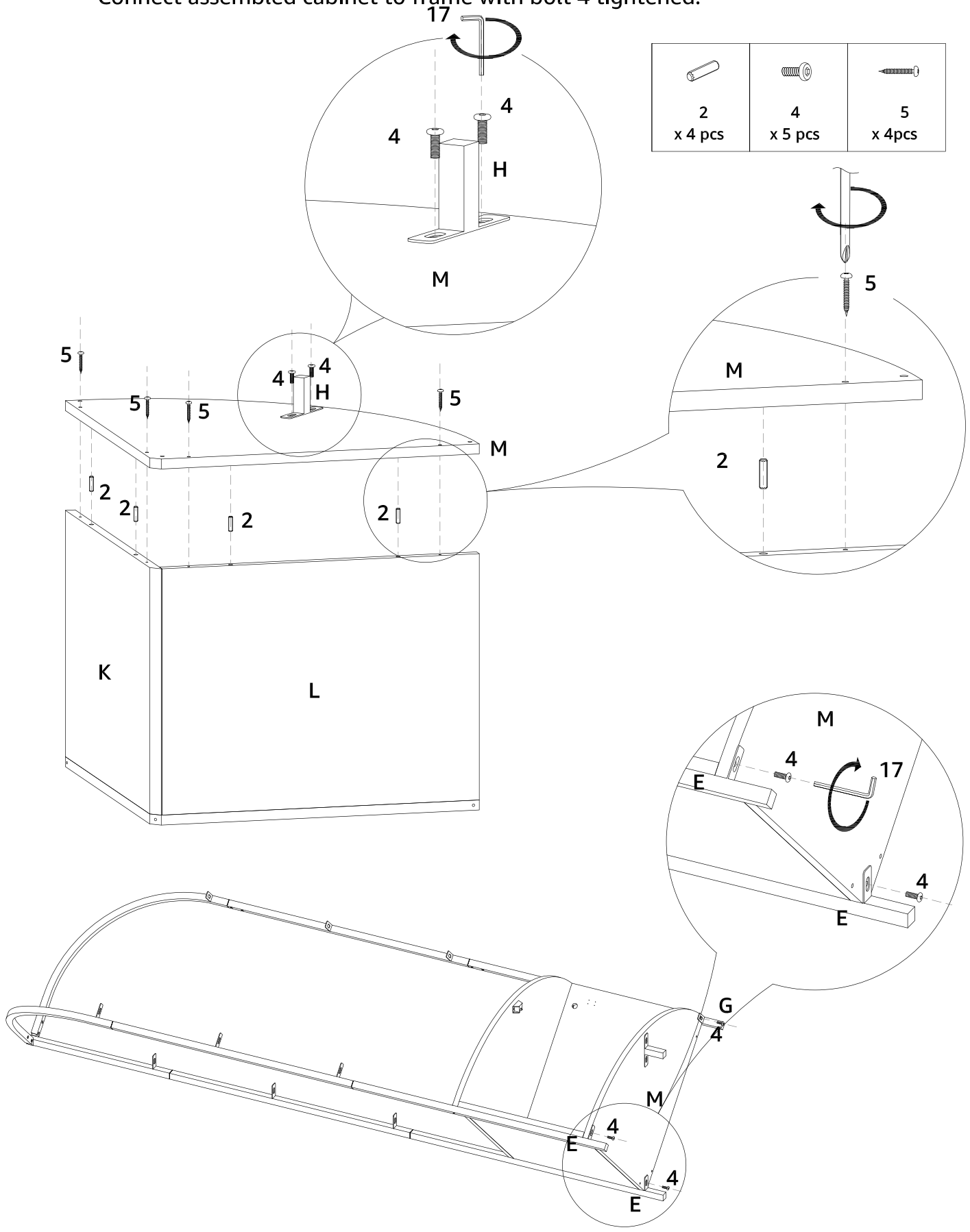

3

Install Support Feet H to Bottom Panel M with bolt 4 tightened.
Insert wooden dowel 2 into side panels L、K and tighten Bottom panel M to side panels L、K with screw 5.
Connect assembled cabinet to frame with bolt 4 tightened.



4

Tighten Top Panel J to frame with screw 6.
Put the Shelf I on the frame and fasten it with bolt 4.



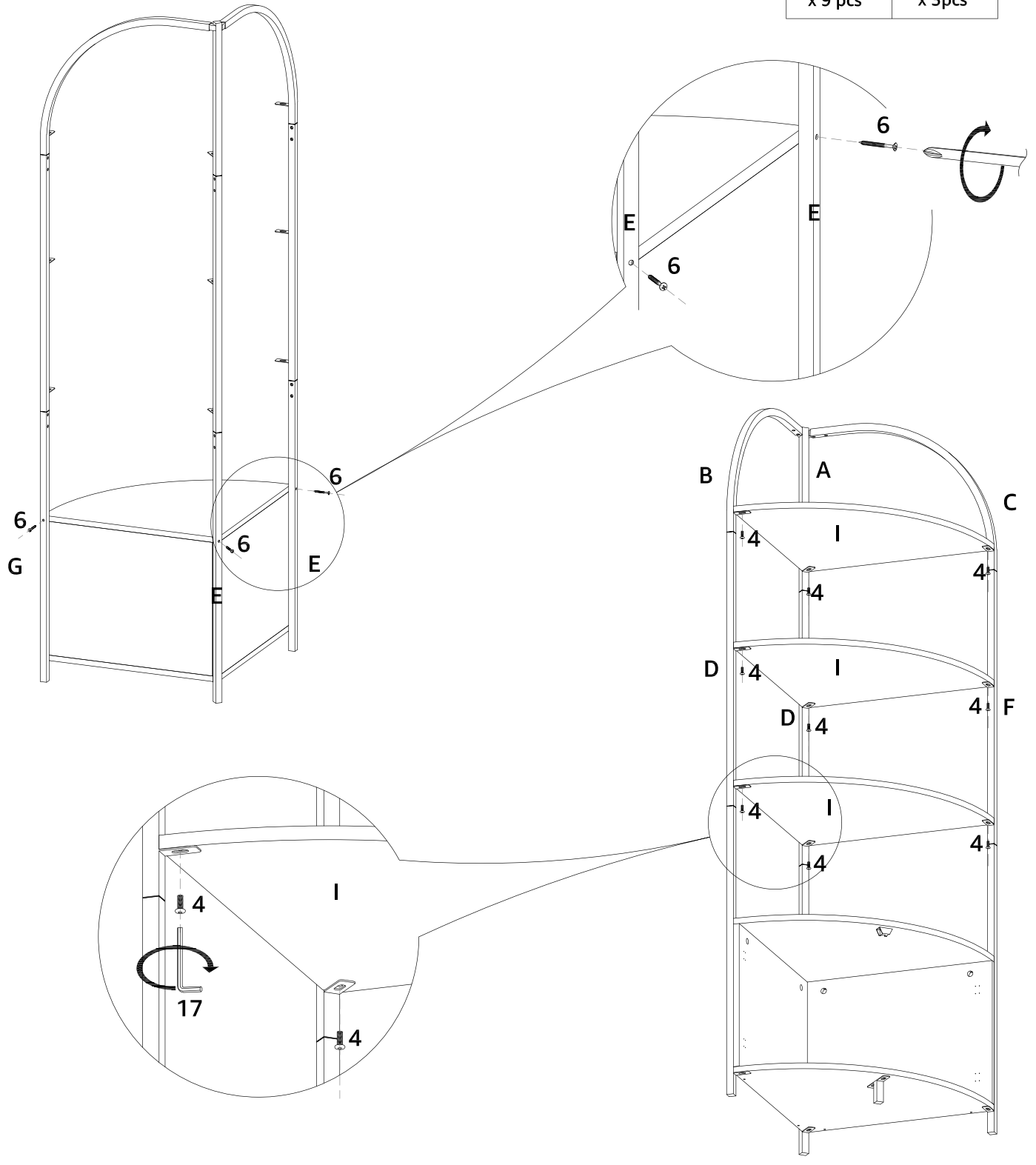

	
4 x 9 pcs	6 x 3 pcs



5

Connect the Handle 11 to two doors N、O with bolt 12



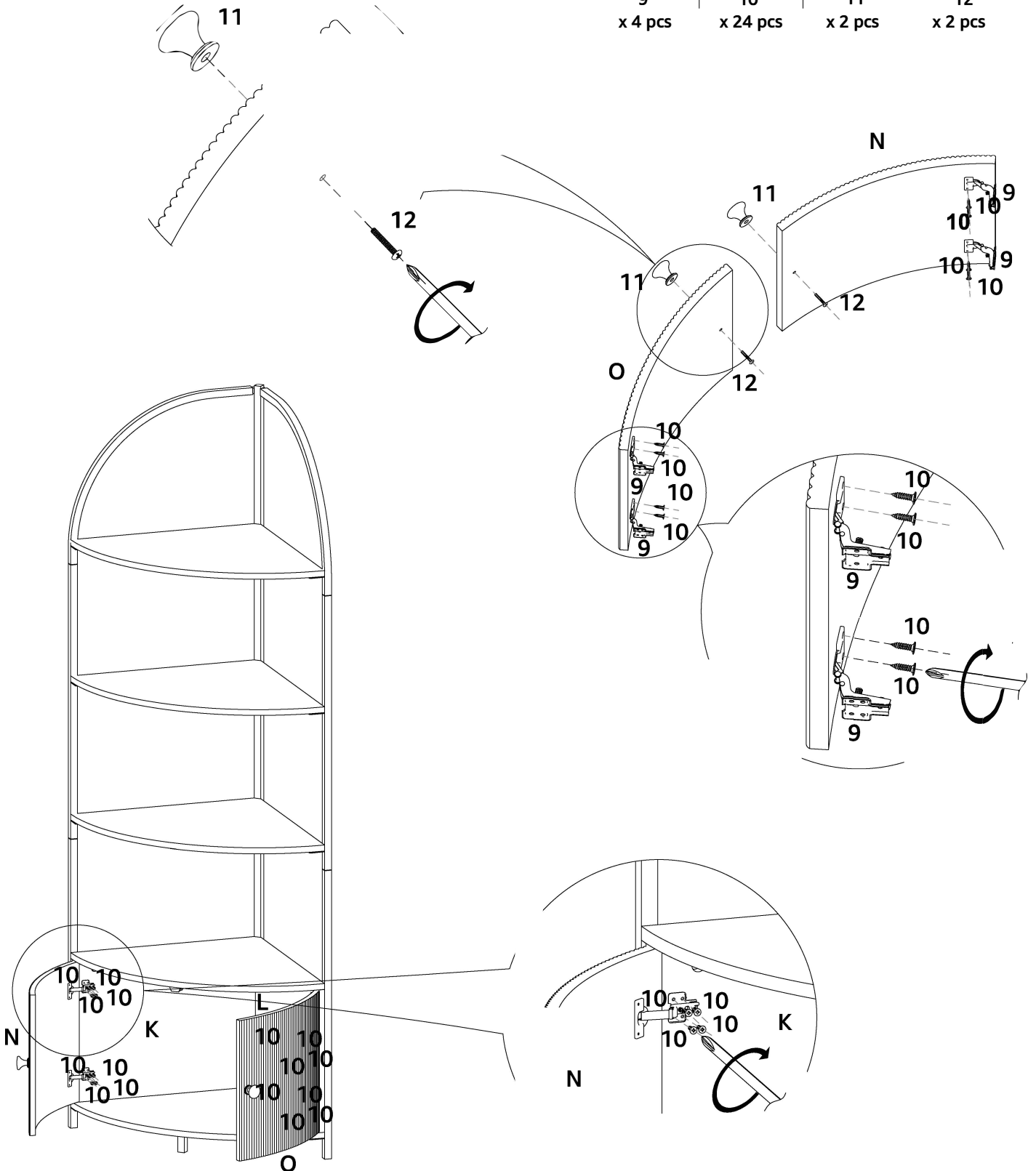

Fixing Hinge 9 on two doors N、O with screw 10 and connect Left Door N、Right Door O to side panels K、L with Hinge 9 and screw 10.

			
9	10	11	12
x 4 pcs	x 24 pcs	x 2 pcs	x 2 pcs



6

For safety use, you can secure the corner shelf where you want it to be on the wall. The following steps for how to install the anti-toppling device.

			
13 x 2 pcs	14 x 2 pcs	15 x 2 pcs	16 x 2 pcs

 Note: Please assemble the door according to the installation steps first. If the cabinet door is deviated, the internal hinge needs to be slowly adjusted to solve the problem.

