

# Dimension/Specification

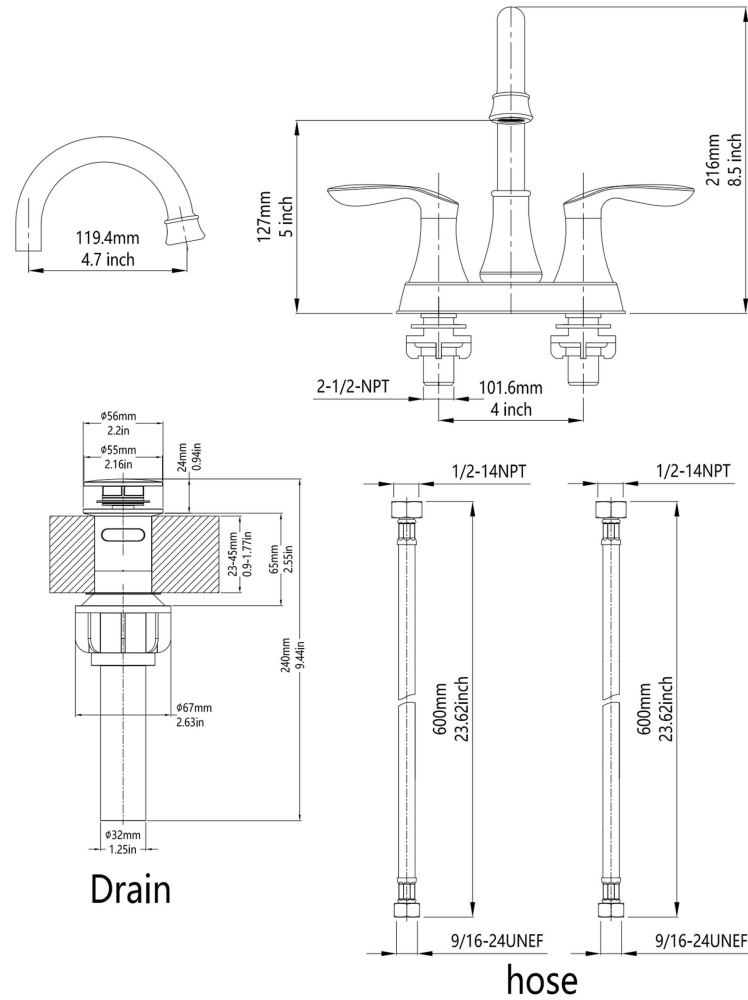

Sku No. 3001