











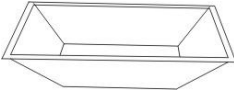

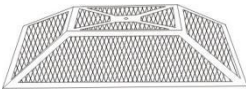

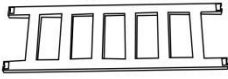

## INSTRUCTION MANUAL

Please check all packing material carefully before discarding, as some parts may be encased in the packing material.

### **Part List**

| Part List | Description      | Qty. | Drawings  |
|-----------|------------------|------|---|
| A         | Corner Post      | 4    |    |
| B         | Mantle           | 4    |     |
| C         | Square Bowl      | 1    |    |
| D         | Log Grate        | 1    |   |
| E         | Mesh Lid         | 1    |   |
| F         | Connecting Plate | 4    |  |
| G         | Ladder Frame     | 4    |   |
| H1        | Bolt (M6x12mm)   | 8    |  |
| H2        | Bolt (M6x15mm)   | 8    |  |
| I         | Bolt (M6x12mm)   | 8    |  |

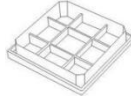
Go out of homes, feel the nature, share the sunny

|   |                                |   |  |
|---|--------------------------------|---|--|
| J | Lid Ring                       | 1 |   |
| K | Protective Cover               | 1 |   |
| L | Poker                          | 1 |   |
| M | Allen Wrench                   | 1 |    |
| N | Plastic Cap<br>(Pre-installed) | 4 |   |
| O | Cooking Gate                   | 1 |  |



### Special Warnings

- Check local bylaws before using the fire pit.
- This fire pit is intended for Outdoor Use Only! DO NOT use on wooden decks.
- This fire pit is intended to Burn Wood Logs Only! DO NOT burn coal, leaves or other combustible materials in the fire pit.
- NOT for use by children. Keep children and pets away from the fire pit.
- Fire pit is hot, use with caution. NEVER touch hot fire pit with bare hands.
- NEVER leave burning fire pit unattended and always extinguish fire completely before leaving the fire pit.
- Keep the fire pit at least 20 feet away from any flammable surface or dwelling.
- DO NOT use near flammable or combustible objects or materials.
- Only CHROMED PLATED COOKING GRID is intended for cooking. LOG GRATE is NOT intended for cooking and SHOULD NOT be used for this purpose.
- Always use gloves and protective glasses when loading the fire pit or extinguishing the fire.
- Have a fire extinguisher available near the fire pit in case of emergency.

Go out of homes, feel the nature, share the sunny

## Operation Instructions

- Place wood logs on grate and light with match. DO NOT overload logs.
- Please use Poker (provided) when handling.
- We do not recommend pouring water over the fire unless necessary. The fire should be allowed to expire on its own.

## Care and Maintenance

This fire pit is a quality-built product and is made to last for many years. The frame structure of this unit is made of powder-coated steel extrusion and should resist rusting under normal use. Should rusting occur, we suggest using a steel brush on the affected area followed by a spray coating of high temperature anti-rust paint. For additional rust proofing of the bowl, grate and mesh lid we recommend that a coat of high temperature primer is applied **before** use. You may cover the fire pit with a Protective Cover when the fire pit is not in use. Ensure the fire pit has completely cooled down before using the Protective Cover.

## Assembly Instructions

Estimated Assembly Time: 20 Minutes

**DO NOT over tighten hardware!**

**Step 1.** Place Mantle parts (B) on a soft, even clean surface with the groove sides upwards to form a square. Connect each by using Bolts (H1). (View Fig 1)

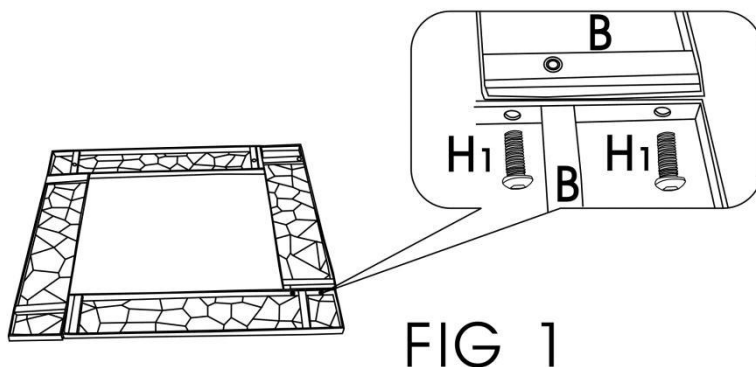

Go out of homes, feel the nature, share the sunny

**Step 2.** Attach Connecting Plates (F) to Corner Posts (A) by using Bolts (I). Tighten the Bolts (I) with an Allen Wrench (M) (provided). Then attach the Corner Posts (A) installed Connecting Plates (F) to the Mantles (B) by using Bolts (H2).

(View Fig 2)

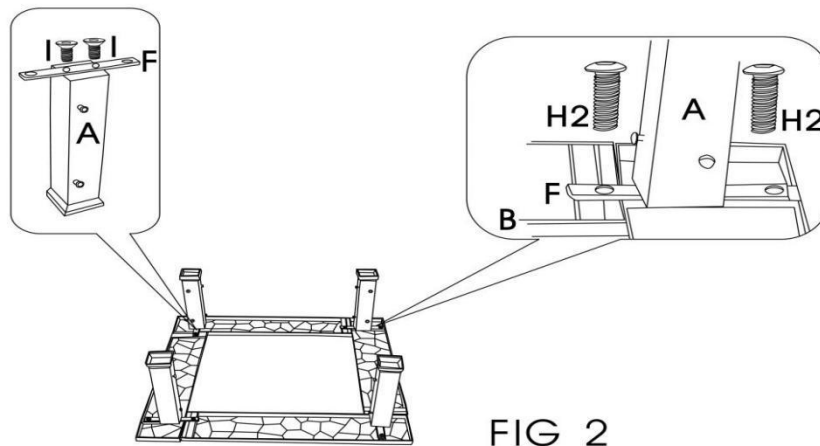

**Step 3.** Mount Ladder Frames (G) to the studs (pre-installed) on the Corner Posts (A). (View Fig 3)

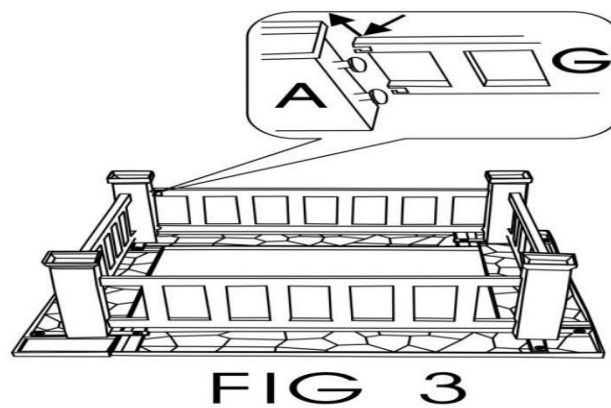

**Step 4.** Place Square Bowl (C) on the base and put Log Grate (D) in the Square Bowl (C). (View Fig 4)

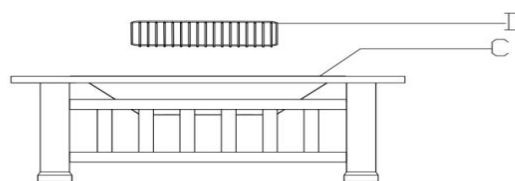

Go out of homes, feel the nature, share the sunny

**Step 5. Place the Cooking Gate (O) on top of the Log Gate(D) in the Square Bowl(C).**(View Fig 5)

O

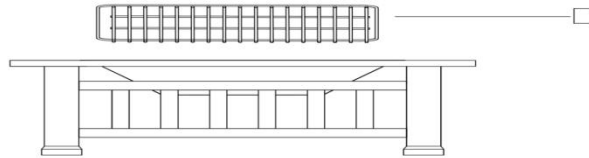

**Step 6. Affix Lid Ring (J) to the Mesh Lid (E) by screwing the lid ring into the upper hole of the mesh lid. Then place the mesh lid on the square bowl.** (View Fig 6)

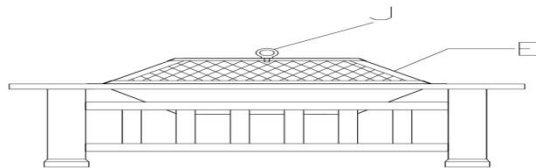

 **WARNING!**

- The use of alcohol, prescription or non-prescription drugs may impair the ability to properly assemble or safely operate this fire pit.
- When using this fire pit, exercise the same precautions you would with any open fire.
- Do not use this fire pit for indoor heating. Toxic carbon monoxide fumes can accumulate and cause asphyxiation or death.

Go out of homes, feel the nature, share the sunny