

ASSEMBLY INSTRUCTION

A*7

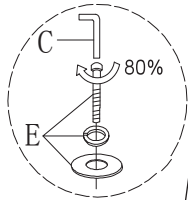

1



B*7



C*1



D*12



E*7

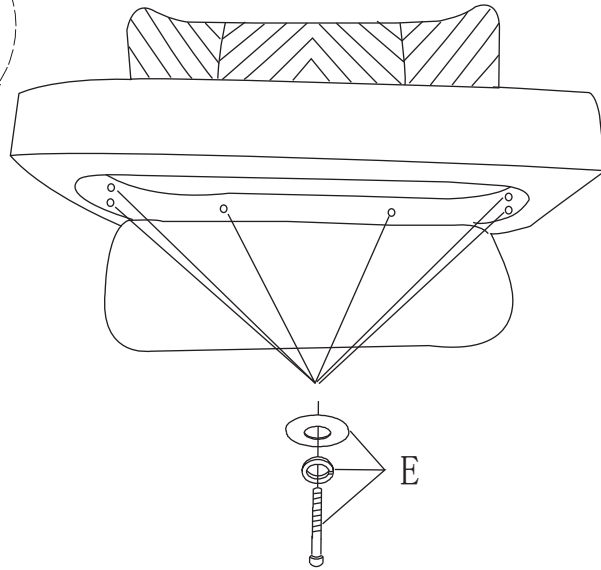

2

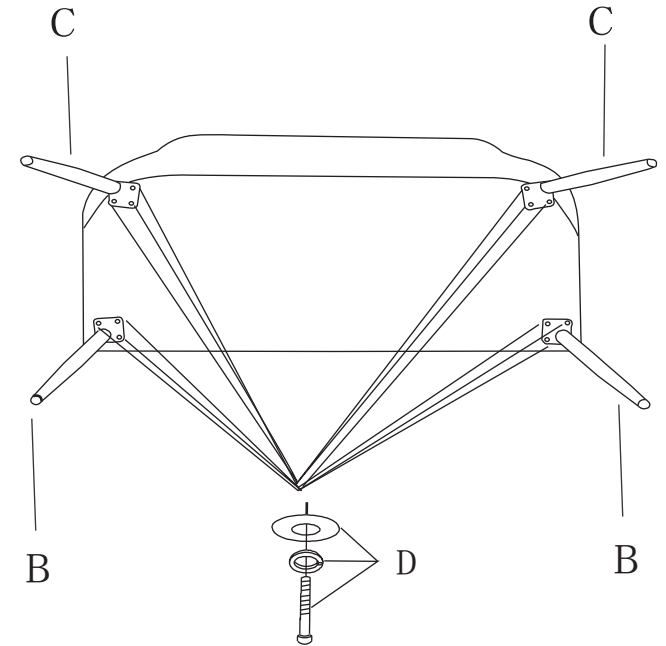
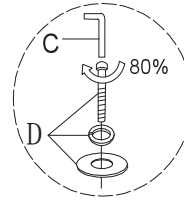

F*1



3

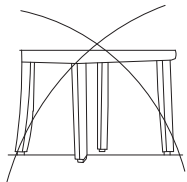

G*1

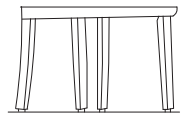

B*2

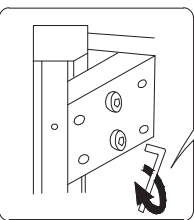

C*2

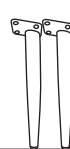

Ziehen Sie alle Schrauben zu 100% fest

4