

INSTRUCTIONS FOR CHANDELIER

Install Accessory

Wire Nut:  X 3

Bracket Machine Screws:  X 2

Install The Main Body Of The Lamps:

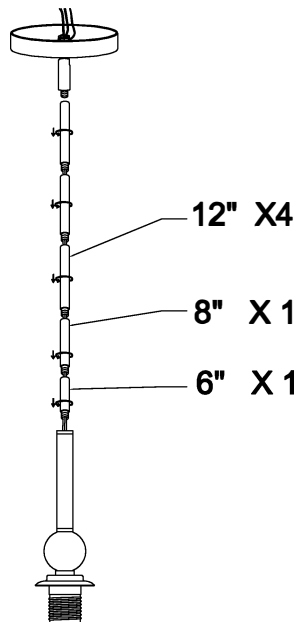
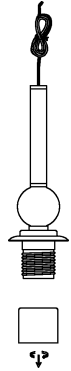

WARNING:

We suggest a qualified, licensed electrician to perform the installation.
Before starting installation disconnect the power by turning off the Circuit Breaker or by removing fuse at the fuse box.

Install Mounting Plate:

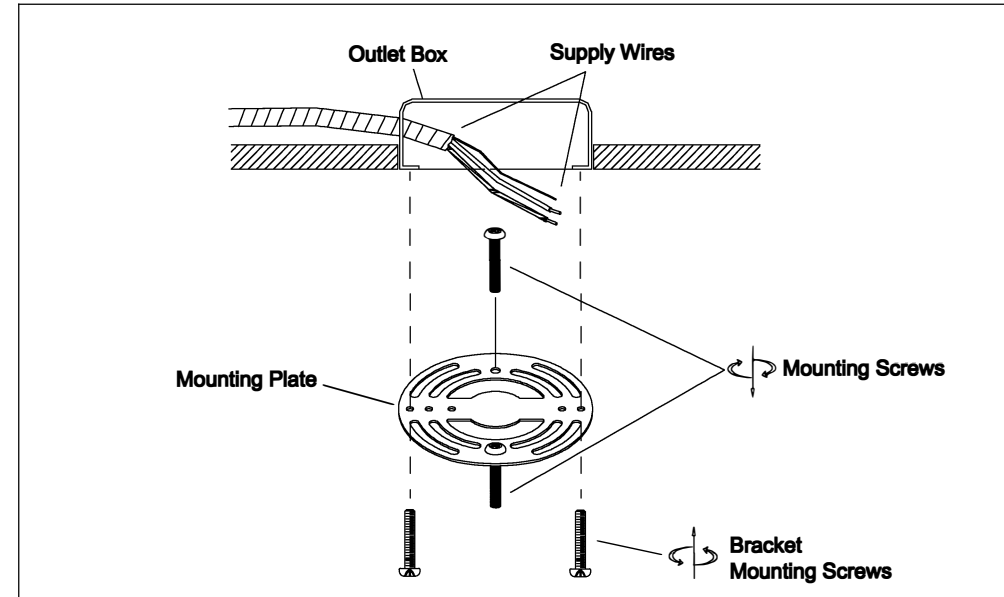

Make Wire Connections:

1. Connect BLACK fixture wire to the BLACK supply wire and the WHITE fixture wire to the WHITE supply wire.
2. Connect the fixture ground wire to the Outlet-Box ground wire.
3. Secure all connections with the supplied wire nuts. Secure all wire connections with electrical tape (not supplied).
4. Tuck all wires carefully into Outlet-Box

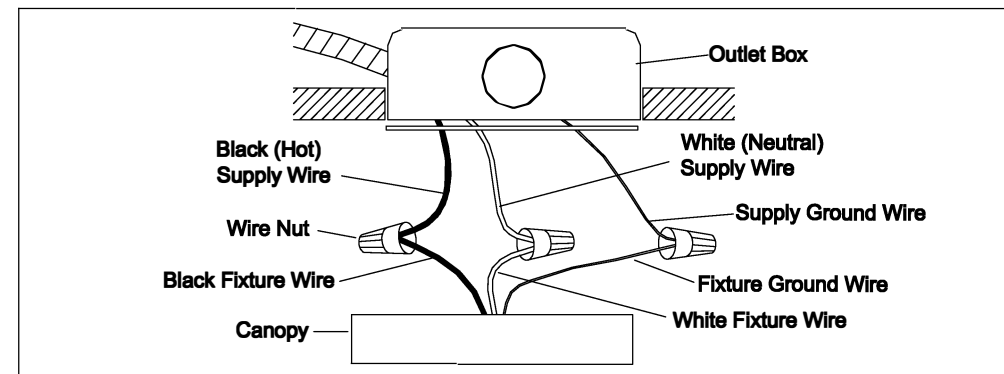

Install Fixture to the Mounting Plate and Insert Bulbs:

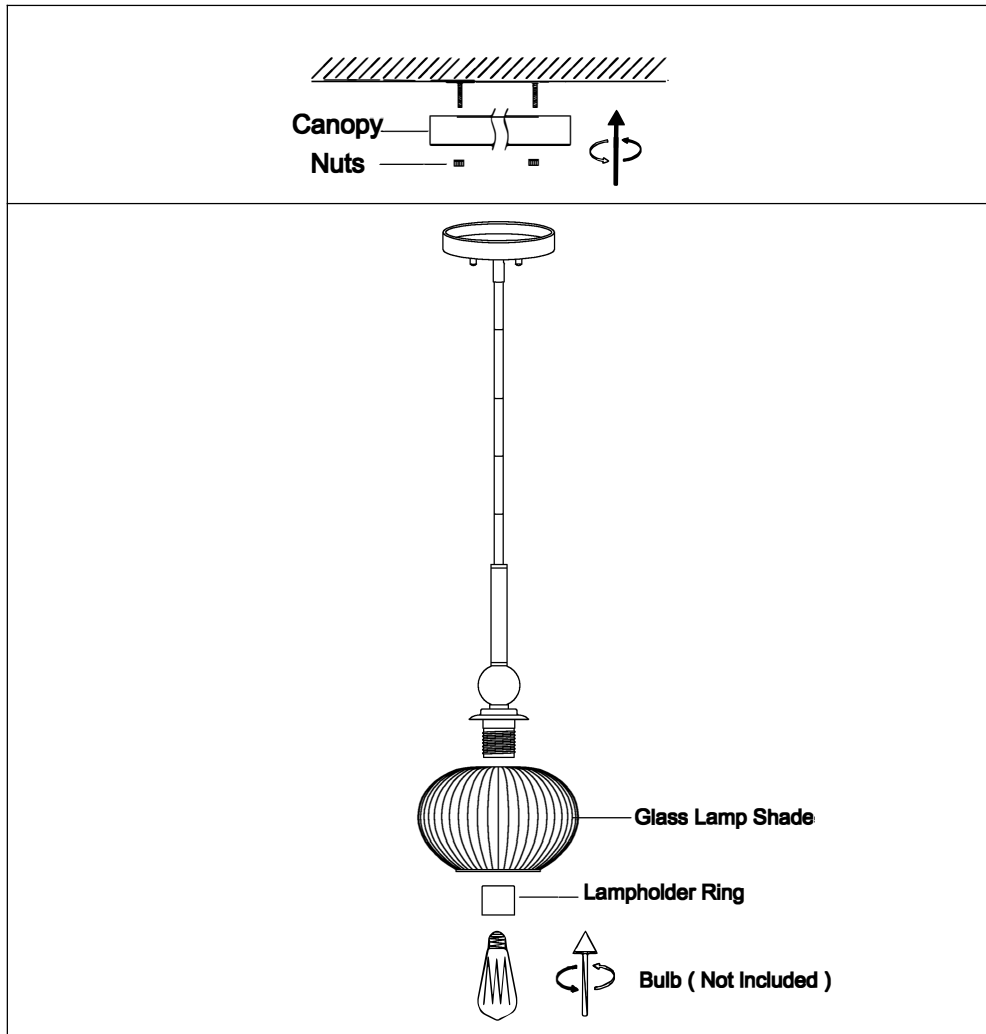

Install Fixture to the Mounting Plate:

1. Position canopy over the mounting plate.
2. Align the holes with the side of the mounting plate.
3. Tighten the glass to the lampholder by Lampholder ring.
4. Insert the Bulbs (MAXIMUM WATTAGE 60W).

Please Note: DO NOT EXCEED THE WATTAGE AS STATED ON THE WARNING LABEL.

5. After the bulbs have been installed, restore the electricity and check the operation of your new fixture.

Dimmer Note: For the best lighting experience, we recommend using a dimmer. Not only does this allow you to create a great ambiance, it allows for energy savings and extends the life of the bulbs.

