

MODEL: IG10600148C-1224WLY

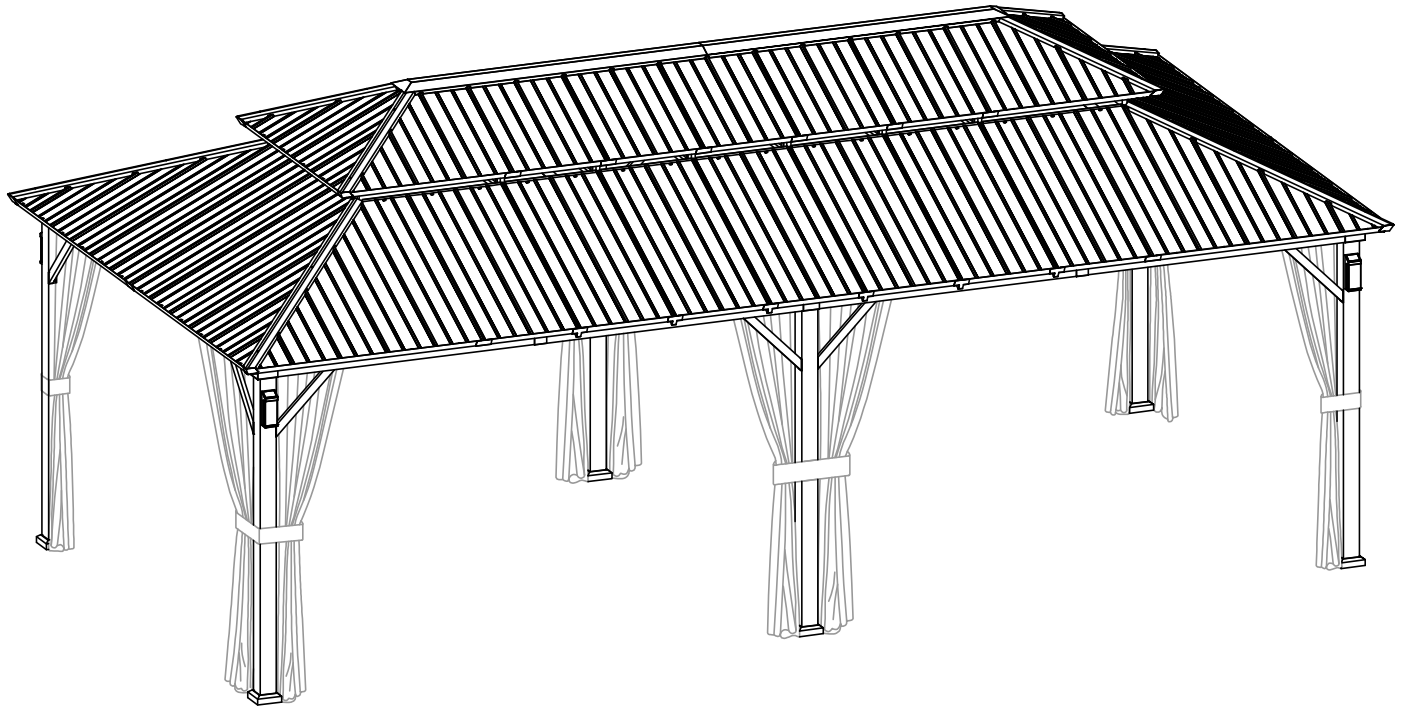

OWNER'S MANUAL

The Horizon 12'x24' Hard Top Gazebo W/ Solar LED light

TABLE OF CONTENTS

ASSEMBLY GUIDE.....	02
USING YOUR PRODUCT.....	05

April 28, 2025

QUESTIONS?



E-mail: support@modernshade.org









Toll Free: 1-888-666-3070

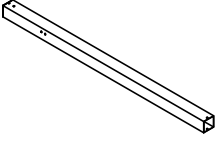
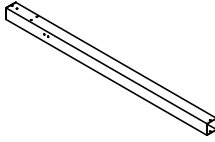
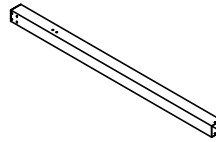
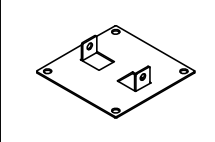
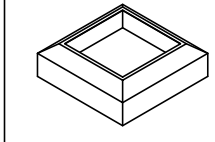
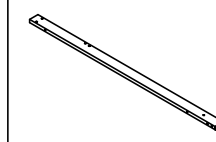
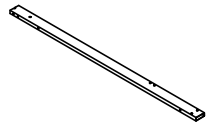
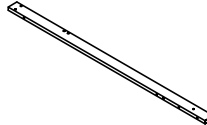
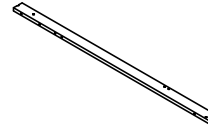
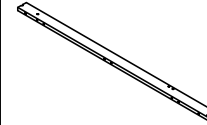
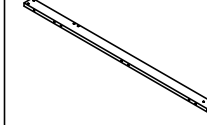

Mon-Fri: 9am---5pm PST.

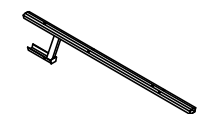
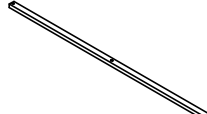
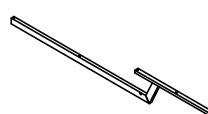
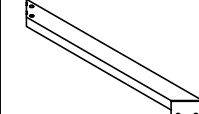
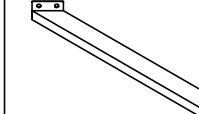
ASSEMBLY GUIDE

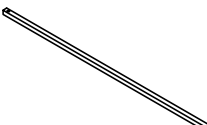
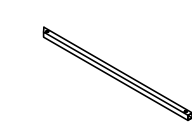
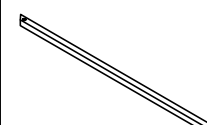
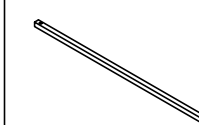
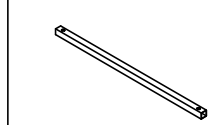
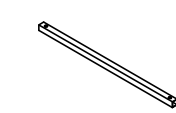
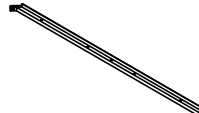
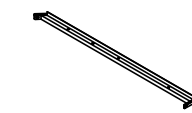
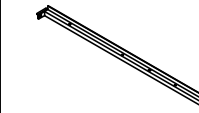
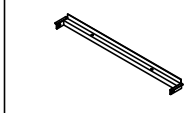
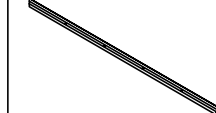
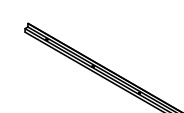
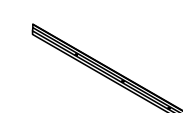
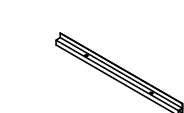
PARTS LIST

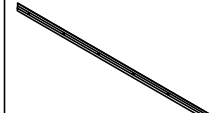
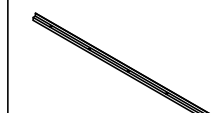
A1 Post 1 (2 pieces) 	A2 Post 2 (2 pieces) 	A4 Post 4 (2 pieces) 	B Foot Base (6 pieces) 	C Foot Cover (6 pieces) 	D1 Cross Beam 1 (2 pieces) 
P0010000302	P0010000402	P0010006402	P0030000201	P0020000201	P0040001302
D2 Cross Beam 2 (2 pieces) 	D6 Cross Beam 6 (2 pieces) 	D7 Cross Beam 7 (2 pieces) 	D8 Cross Beam 8 (2 pieces) 	D9 Cross Beam 9 (2 pieces) 	E1 Roof Rib 1 (4 pieces) 
P0040001402	P0040014802	P0040014902	P0040015002	P0040015102	P0070000201
E2 Roof Rib 2 (4 pieces) 	F1 Middle Cross Beam 1 (6 pieces) 	F3 Middle Cross Beam 3 (12 pieces) 	G1 Support Bracket 1 (6 pieces) 	G2 Support Bracket 2 (6 pieces) 	H3 Mosquito Net Rod 3 (4 pieces) 
P0070000301	P0080000101	P0080002001	P0050000102	P0050000202	P0100000401
H5 Mosquito Net Rod 5 (8 pieces) 	J1 Top Beam 1 (4 pieces) 	J4 Top Beam 4 (4 pieces) 	J5 Top Beam 5 (2 pieces) 	J6 Top Beam 6 (4 pieces) 	J7 Top Beam 7 (14 pieces) 
P0100003101	P0090000101	P0090000401	P0090000501	P0090015501	P0090015601
J8 Top Beam 8 (10 pieces) 	K5 Roof Support 5 (2 pieces) 	K15 Roof Support 15 (2 pieces) 	K16 Roof Support 16 (2 pieces) 	K17 Roof Support 17 (10 pieces) 	K18 Roof Support 18 (2 pieces) 
P0090015701	P0090001001	P0090015801	P0090015901	P0090016001	P0090016101
K19 Roof Support 19 (2 pieces) 	K20 Roof Support 20 (2 pieces) 	K21 Roof Support 21 (10 pieces) 	K22 Roof Support 22 (2 pieces) 	K23 Roof Support 23 (2 pieces) 	K24 Roof Support 24 (2 pieces) 
P0090016201	P0090016301	P0090016401	P0090016501	P0090016601	P0090016701

ASSEMBLY INSTRUCTIONS

•Please carefully unpack each of the components and hardware. check the components against the parts list and make sure there are no missing parts. lay pieces on cardboard or a soft mat to help protect the pieces from scratches.

⚠ CAUTION

Watch for sharp edges when handling the pieces, wear gloves to avoid injury.

STEP 01 Slide foot base **B** and foot cover **C** onto post **A1**. Use two (2) **AA** bolts and two (2) **DD** flat washers to attach foot base **B** to post **A1**. Repeat with the other post **A1**, two (2) **A2** and two (2) posts **A4**.

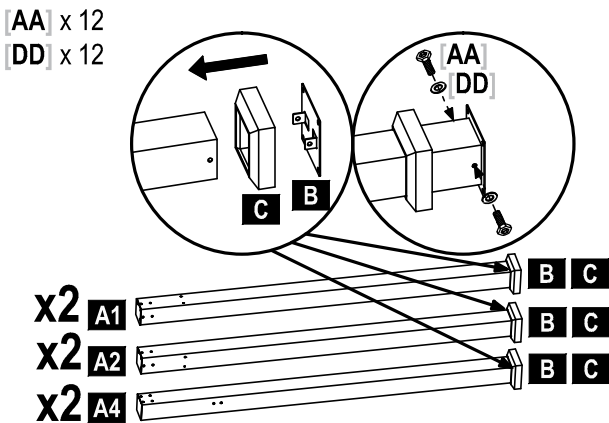

STEP 03 Slide cross beam **D7** and **D9** onto connector **L12**. Slide connector **L2** over the connection. Use four (4) **AA** bolts and four (4) **DD** flat washers to secure the connection. Repeat to make a second assembly.

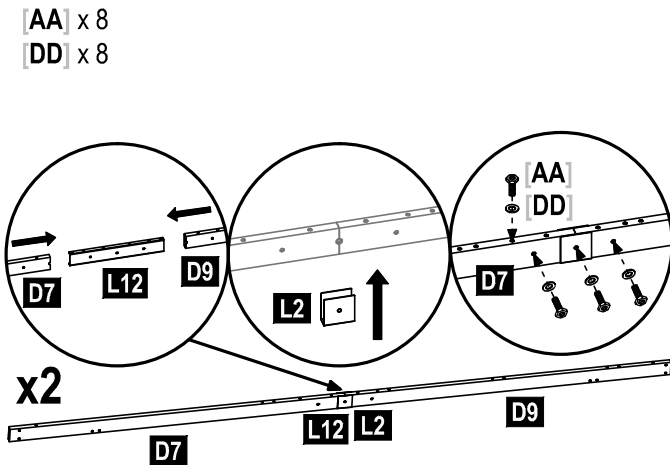

- For ease of assembly, it is recommended to have 3 or more people and allow enough time to completely finish the assembly. assembly can take 6-8 hours. a step-ladder is required for assembly (not included).
- Follow step by step instructions, and follow all safety warnings provided with your tools.
- DO NOT tighten screws until all the screws and washers are properly installed. Tighten screws securely, do not over tighten.
- Gazebo should not be used in inclement weather and high winds.

STEP 02 Slide cross beam **D6** and **D8** onto connector **L12**. Slide connector **L2** over the connection. Use four (4) **AA** bolts and four (4) **DD** flat washers to secure the connection. Repeat to make a second assembly.

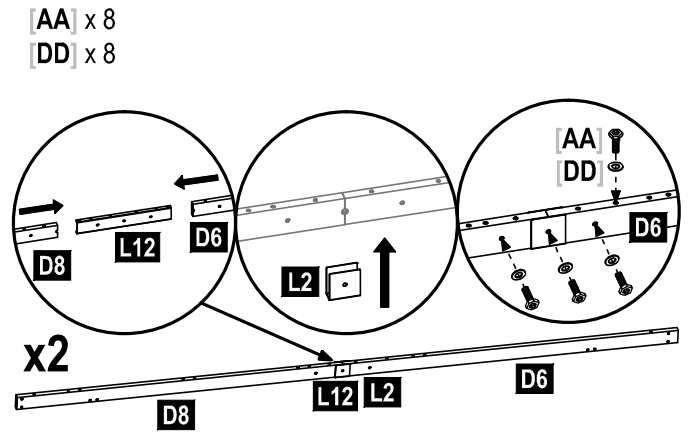

STEP 04 Slide cross beam **D1** and **D2** onto connector **L11**. Slide connector **L2** over the connection. Use five (5) **AA** bolts and five (5) **DD** flat washers to secure the connection. Repeat to make a second assembly.

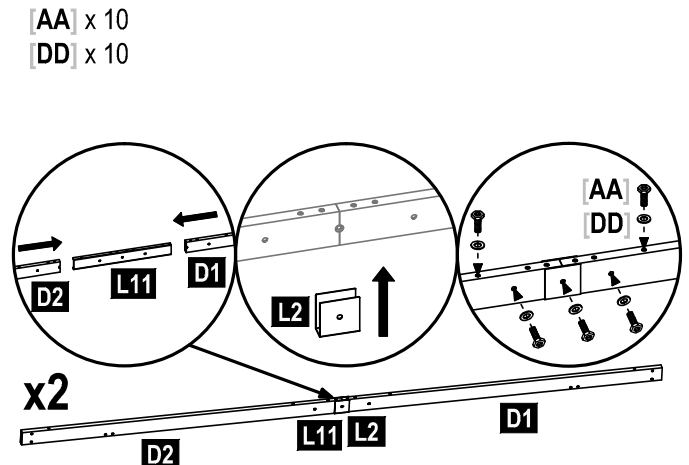

STEP 05 Use two (2) **[AA]** bolts and two (2) **[DD]** flat washers to attach each end of cross beam assembly **[D6]** **[D8]** and **[D7]** **[D9]** to post **[A1]**, **[A2]** and **[A4]**. Repeat to make a second assembly.

STEP 06 Use two (2) **[AA]** bolts and two (2) **[DD]** flat washers to attach each end of cross beam assembly **[D1]** **[D2]** to post **[A1]** and **[A2]**. Repeat with the other cross beam assembly **[D1]** **[D2]**.

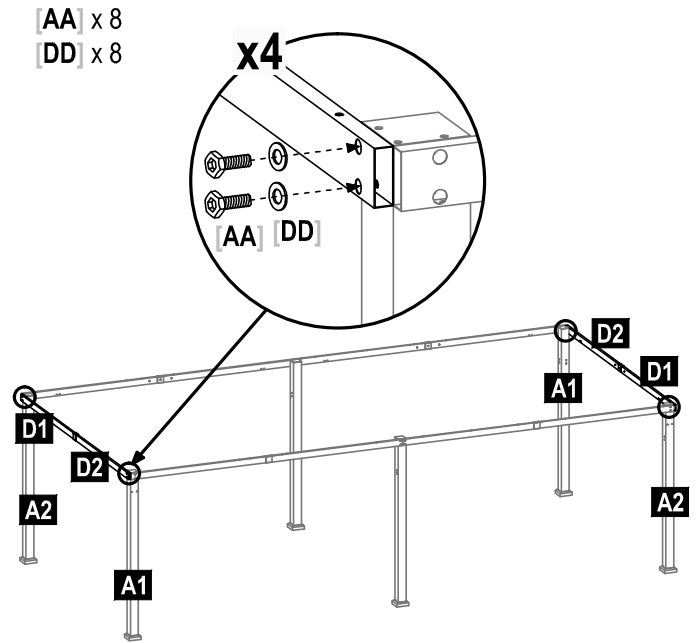
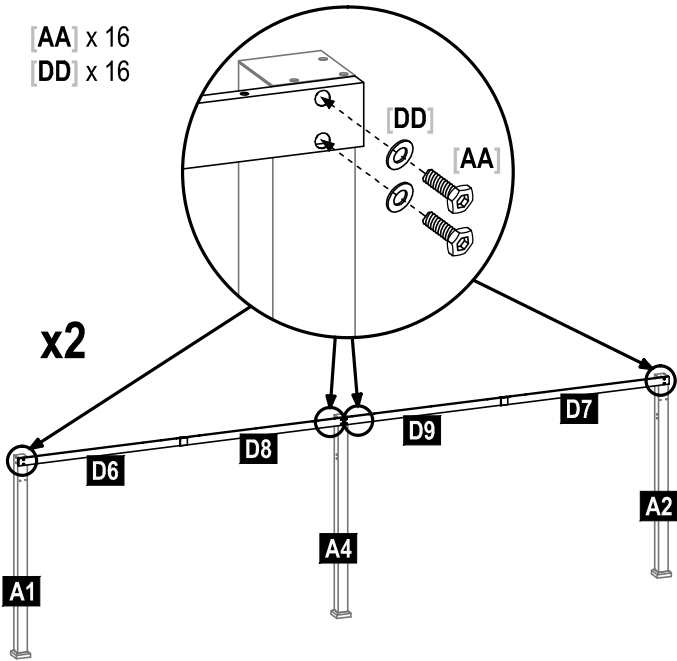

STEP 07 CRITICAL: SQUARE UNIT BEFORE PROCEEDING TO NEXT STEPS. ONCE SQUARE, TIGHTEN ALL HARDWARE.

