

# 6-Cube Organizer

INSTALLATION INSTRUCTIONS

## SAFETY PRECAUTIONS

### BEFORE BEGINNING

- Please read all instructions carefully.
- Familiarize yourself with all parts (see “PARTS”) and check quantities.
- Follow all safety precautions (see “SAFETY PRECAUTIONS”).

### WARNING

- **CHOKING HAZARD FOR SMALL CHILDREN.** This unit contains small parts which could be a choking hazard for small children. Children should be under adult supervision at all times or serious injury could occur.
- **ALWAYS UNLOAD UNIT PRIOR TO MOVING THE UNIT.** The weight of personal belongings can cause the unit to become unstable and either tip or collapse. Serious bodily injury and/or damage to personal belongings may occur.
- **DO NOT OVERLOAD UNIT.** If any shelf, top, or bottom of unit bows or bends, it is overloaded. The shelf, top, or bottom could collapse and cause serious bodily injury and/or damage to personal belongings.
- **DO NOT CLIMB OR STEP ON THE UNIT.** The unit may become unstable and either tip or collapse. Serious bodily injury and/or damage to personal belongings may occur.
- **DO NOT USE THIS UNIT AS A TELEVISION STAND.** Serious bodily injury and/or damage to personal belongings may occur.
- **DO NOT MOUNT OR ATTACH ANYTHING TO THE SIDES, REAR, OR FRONT OF THE UNIT.** This can create a force which can cause the unit to tip. Serious bodily injury and/or damage to personal belongings may occur.
- **DO NOT STACK UNITS.** Stacking of units can cause an unsafe tip-over hazard which may cause serious bodily injury and/or damage to personal belongings.
- **DO NOT HANG THIS UNIT ON THE WALL.** The product structure is not designed for wall hanging. Serious bodily injury, damage to personal belongings, and/or damage to the wall may occur.
- **FOLLOW PROPER SAFETY PROCEDURES WHEN USING POWER TOOLS AND LADDERS.**
- **PROTECT YOUR WORK SURFACE DURING ASSEMBLY.** This can prevent scratching or damage to table tops, wood floors, etc.



### FOLLOW INSTRUCTIONS CAREFULLY

Please do not return product to the retail store. For product assistance and warranty information please call us.

#### Manufacturer Warranty

Manufacturer will replace any missing or damaged part due to manufacturer defect for one year after purchase. Please have proof of purchase for warranty claims.

- Do not let any sharp objects touch or rub the surface of the product.
- When assembling, do not let children play around the working area.
- Please confirm all parts are correct before starting the assembly process.
- **DO NOT OVERTIGHTEN. DO NOT USE POWER TOOLS.** Power tools can overtighten screws and strip threads.
- Only use hex wrench provided.

We recommend you hand-tighten screws. Please note location of predrilled holes.







## PARTS

Call us for parts and service. For faster service, have the style number ready when calling.

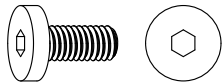
### TOOLS REQUIRED

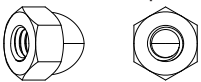
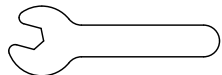

### HARDWARE PROVIDED

	Name	Size (Qty)	Part Number
AA	Allen Wrench 	4 mm. (1)	65649
BB	Hex Screw 	M6 x 15 mm. (8)	65629
CC	Long Screw 	M7 x 48 mm. (4)	65624
DD	X Brace Screw 	M4 x 9 mm. (4)	62284
EE	X Brace Cap Nut 	M4 x .7 mm. (4)	62285
FF	Stamped Wrench 	M4 (1)	73498
GG	L-Bracket 	51 mm. (2)	62280
HH	L-Bracket Screw 	M4 x 15 mm. (2)	62281
II	Wall Mount Screw 	M4 x 35 mm. (2)	62283

## PARTS

Call us for parts and service. For faster service, have the style number ready when calling.

## PRODUCT

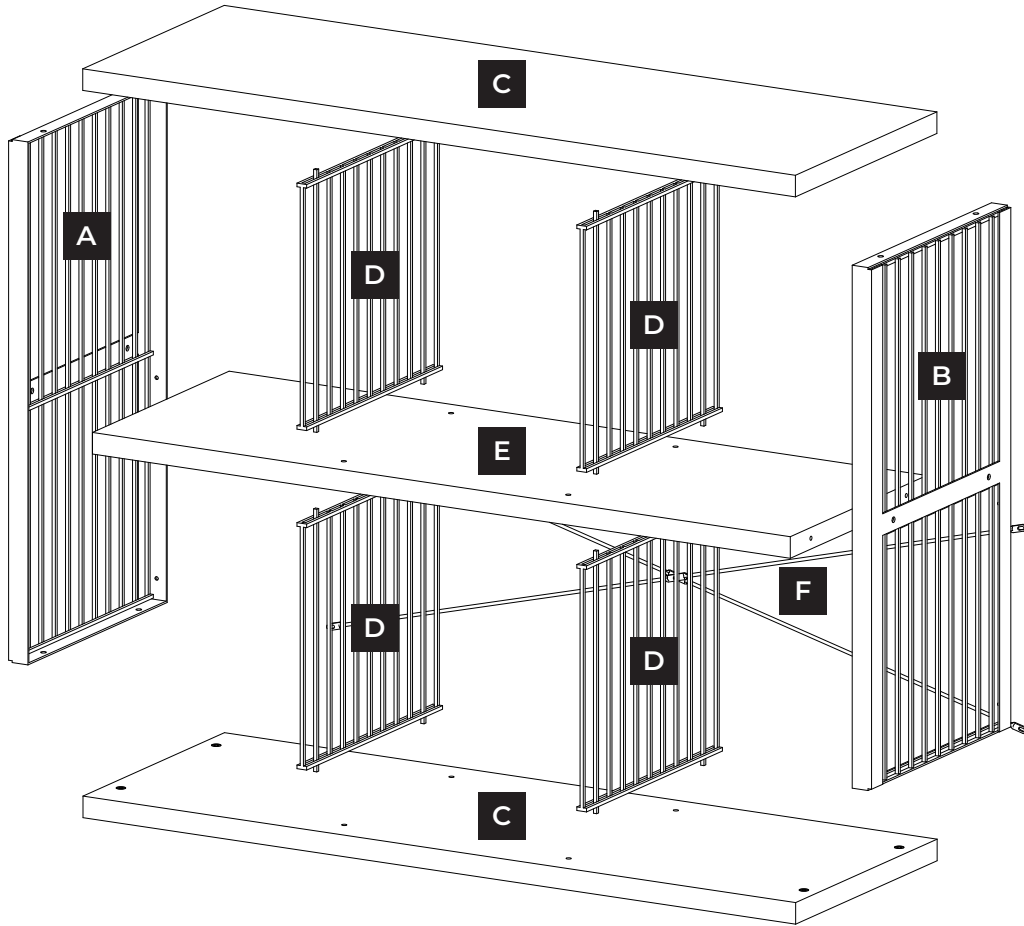

	Name	Qty	Part Number
A	Left Metal Side Panel	1	62391
B	Right Metal Side Panel	1	62301
C	Top/Bottom Wood Panel	2	61156   61157   61158
D	Vertical Divider	4	62393
E	Wood Shelf	1	61197   61198   61199
F	X Brace	1	62306

\*Please note location of predrilled holes on each part.

## STEP 1

## Connect metal side panels to bottom wood panel.

Align both metal side panels (A & B) with the bottom wood panel (C) as shown. The top/bottom wood panels (C) will only have holes on one side. Make sure the horizontal bars on each metal side panel are below the screw holes and facing toward the inside of the assembly (fig. 1). The two X brace holes on the side of each panel should be facing toward the back of the assembly.

Use the supplied allen wrench (AA) to secure both metal side panels (A & B) to the bottom wood panel (C) using two hex screws (BB) per side.

**BB** Hex Screw x4

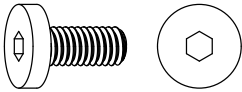

**AA** Allen Wrench x 1

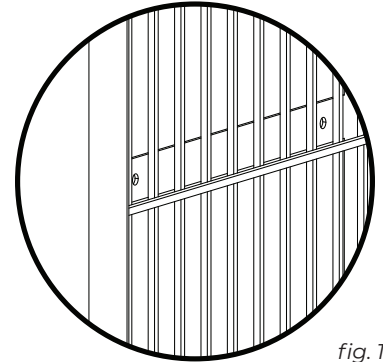
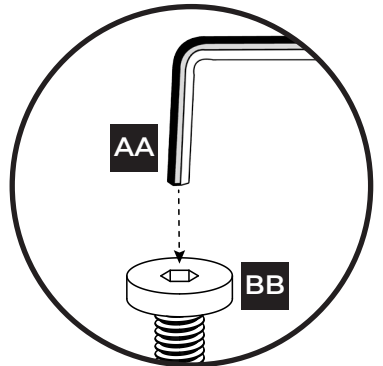
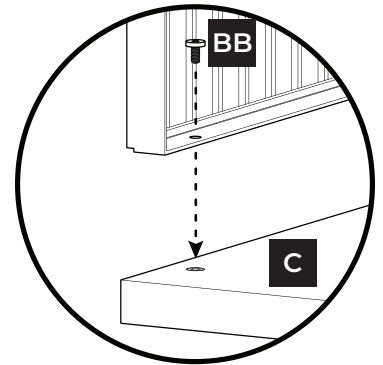
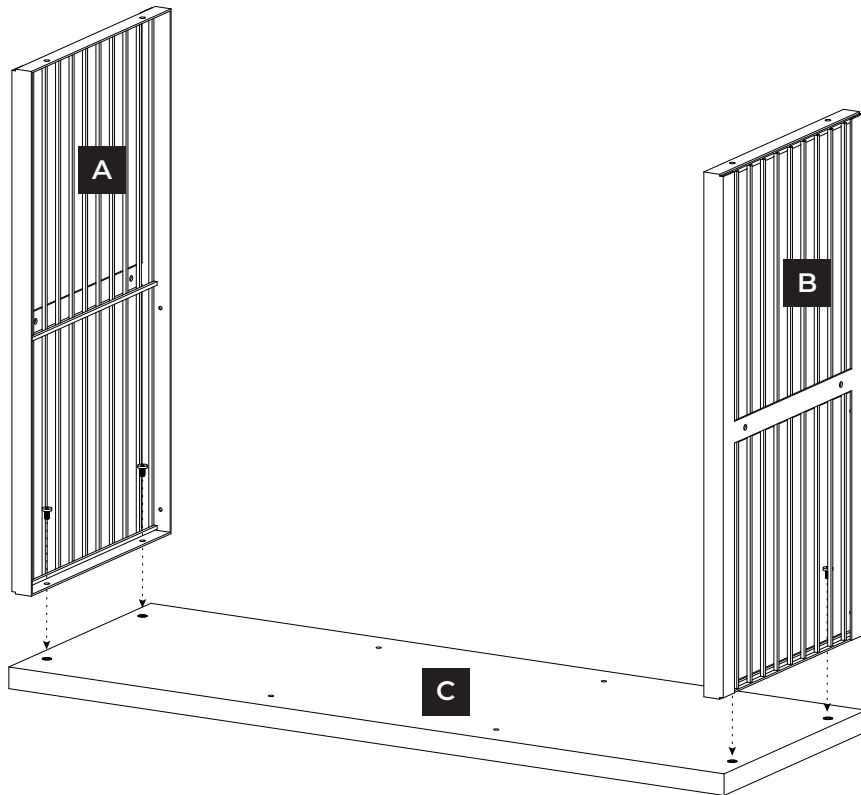

fig. 1



\*Please note location of predrilled holes on each part.

## STEP 2

Place bottom vertical dividers.

Align two vertical dividers (D) with the holes on the bottom wood panel (C) as shown.

Push dividers into place.

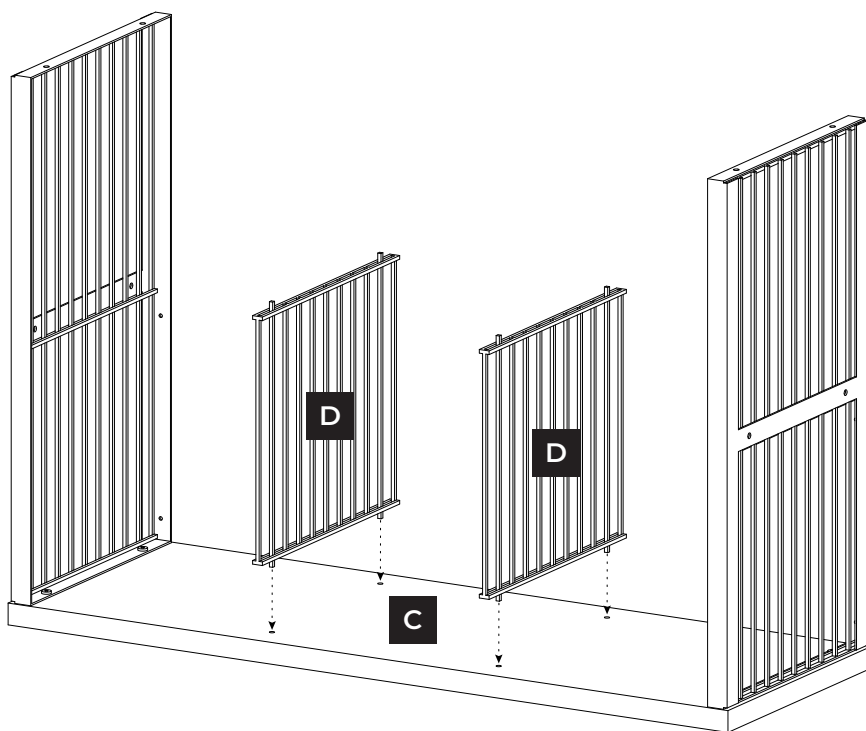
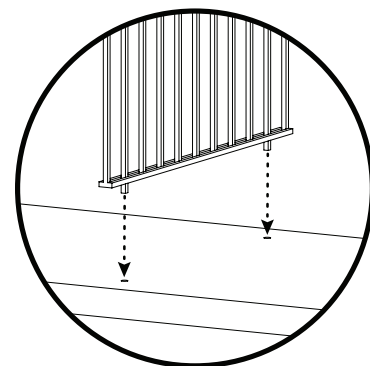

*\*Please note location of predrilled holes on each part.*

### STEP 3

### Attach wood shelf.

Align the holes on the bottom of the wood shelf (E) with the top of the vertical dividers (D). The wood shelf (E) should rest on the lower horizontal bars of the metal side panels (A & B).

Push wood shelf into place.

Use the supplied allen wrench (AA) to secure both metal side panels (A & B) to the wood shelf (E) using two long screws (CC) per side.

**CC** Long Screw x 4



**AA** Allen Wrench x 1

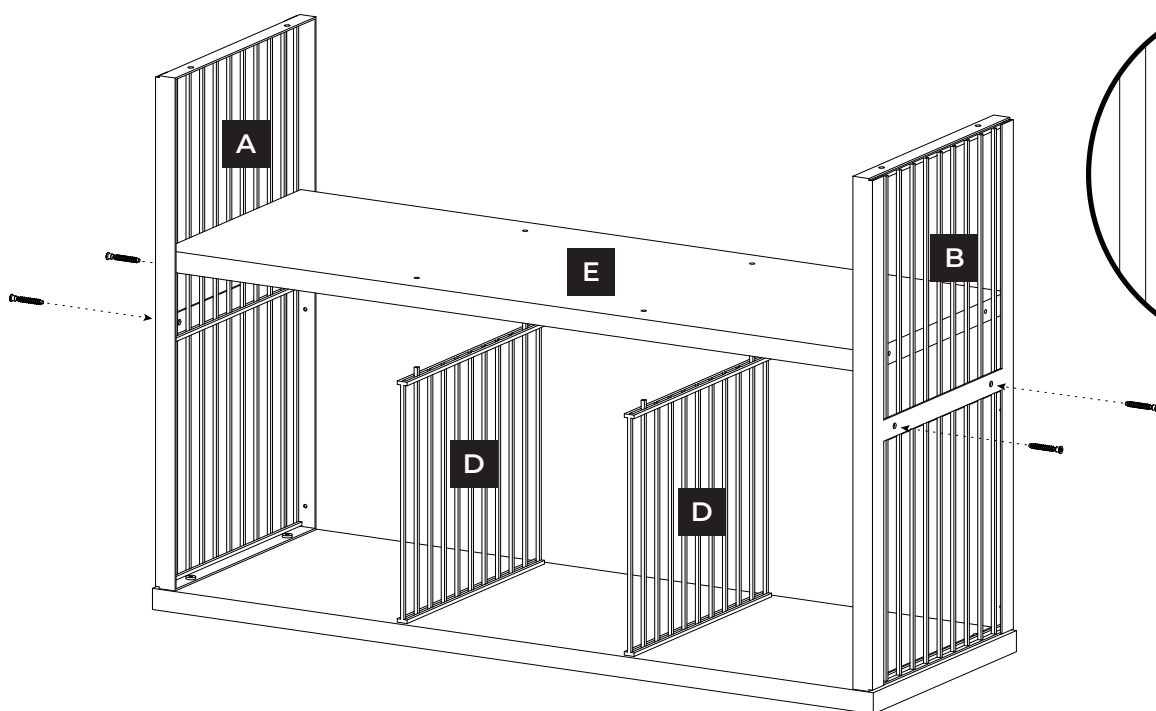
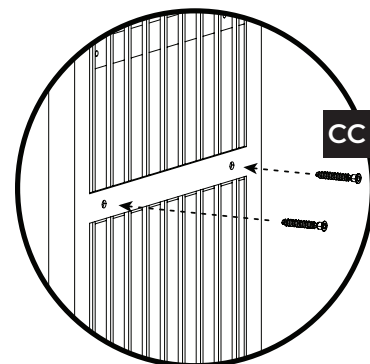
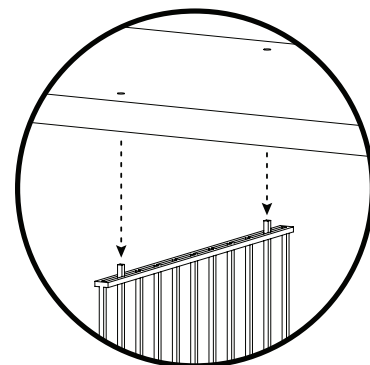

\*Please note location of predrilled holes on each part.

## STEP 4

Place top vertical dividers.

Align two vertical dividers (D) with the holes on the top of the wood shelf (E) as shown.  
Push dividers into place.

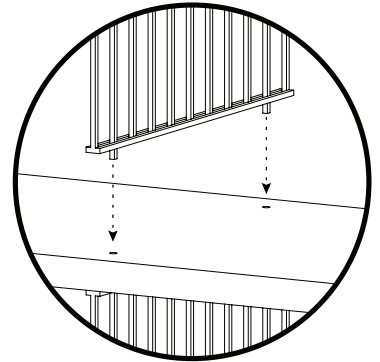
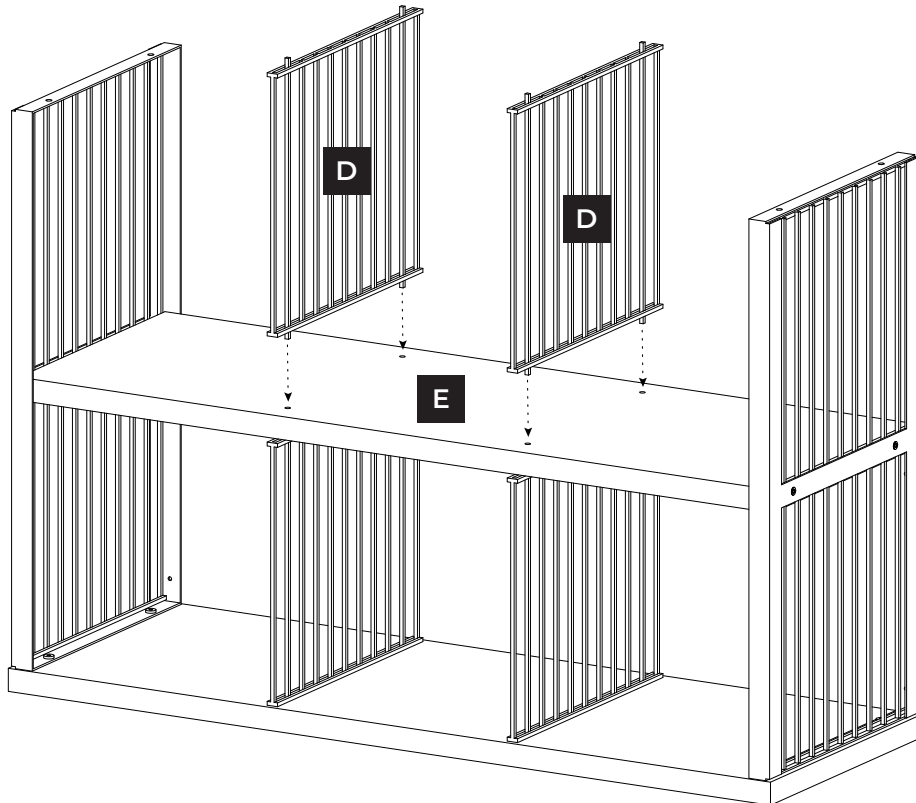

*\*Please note location of predrilled holes on each part.*



## STEP 5

## Connect metal side panels to top wood panel.

Align the holes on the bottom of the top wood panel (C) with the top of the vertical dividers (D).

Use the supplied allen wrench (AA) to secure both metal side panels (A & B) to the top wood panel (C) using two hex screws (BB) per side.

**BB** Hex Screw x 4

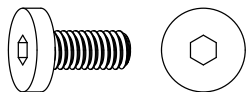

**AA** Allen Wrench x 1

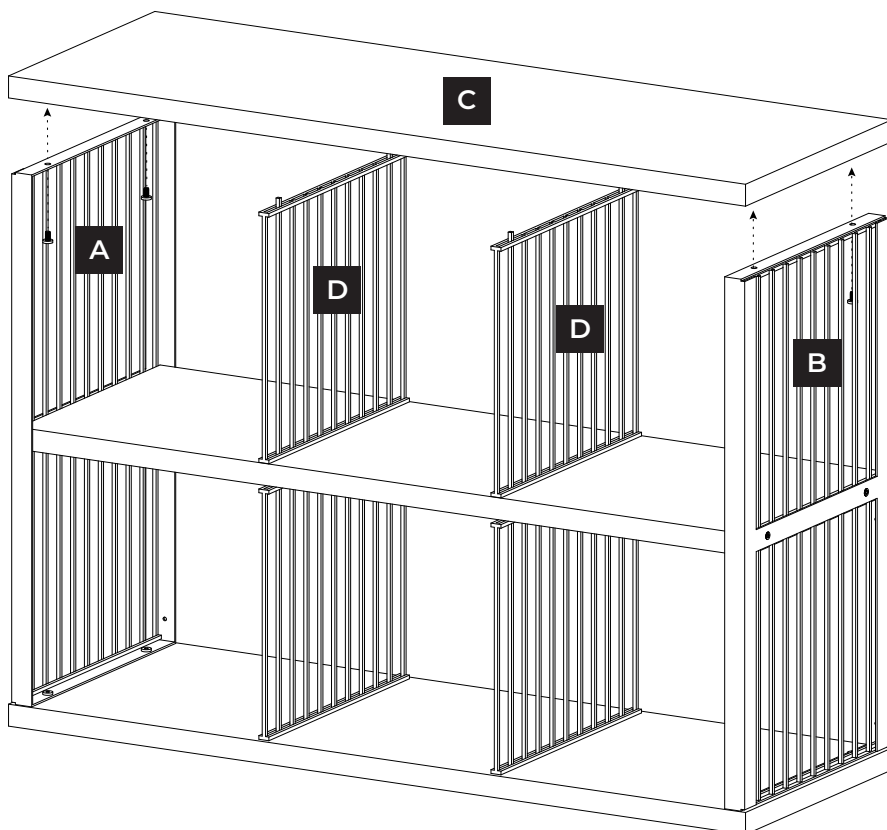
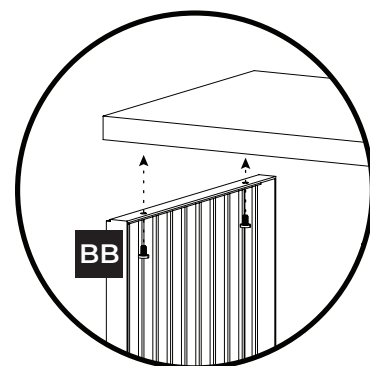

*\*Please note location of predrilled holes on each part.*

## STEP 6

## Secure X brace to back of unit.

Align the X brace (F) with the predrilled holes on the left metal side panel (A).

Secure the X brace to the left metal side panel (A) by using the stamped wrench (FF) to attach two X brace cap nuts (EE) to two X brace screws (DD).

Align the X brace (F) with the predrilled holes on the right metal side panel (B).

Secure the X brace to the right metal side panel (B) by using the stamped wrench (FF) to attach two X brace cap nuts (EE) to two X brace screws (DD).

**DD** X Brace Screw x 4



**EE** X Brace Cap Nut x 4

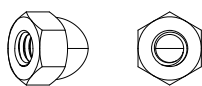

**FF** Stamped Wrench x 1

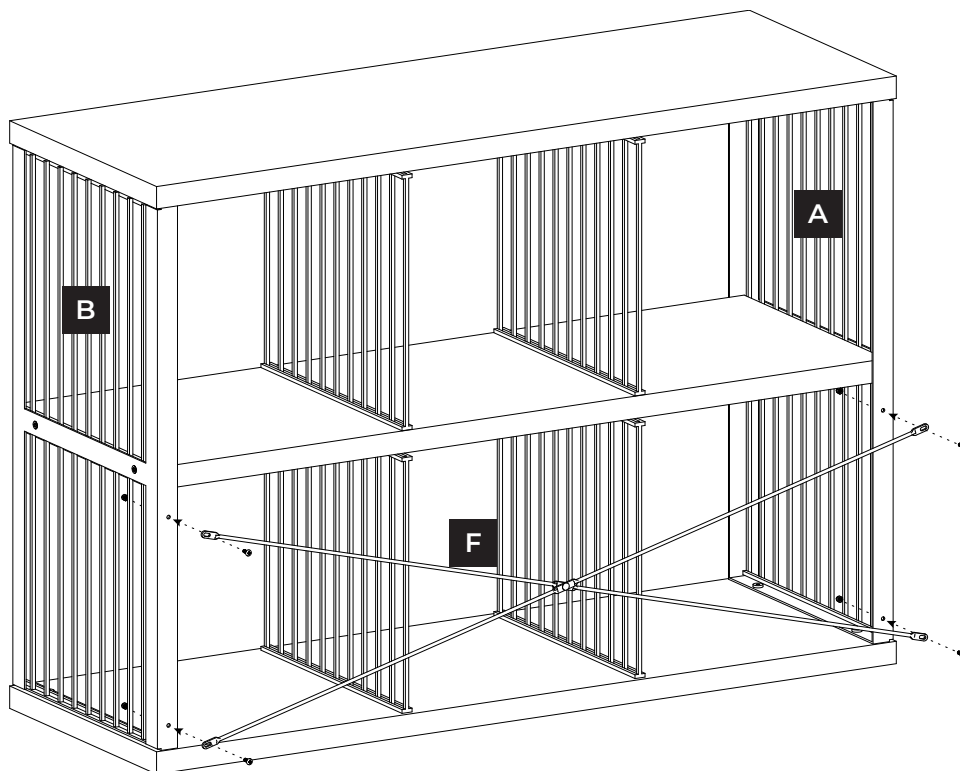
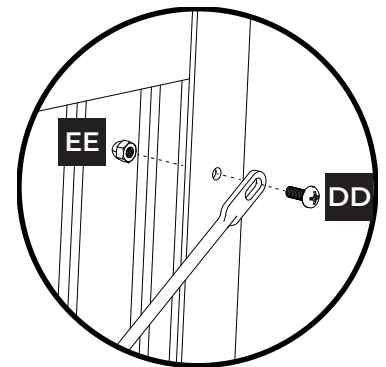
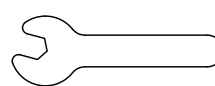

*\*Please note location of predrilled holes on each part.*

# STEP 7

## Secure to wall using stud mounting.

Align top of unit with wall studs. Position L-bracket (GG) on wall stud and bottom of the top wood panel (C). The longer side of the bracket will connect to the top wood panel and the shorter side will connect to the stud.

Secure the bracket (GG) to the top wood panel (C) using one L-bracket screw (HH). The screw should be mounted 1/2 in. from the back edge of the top wood panel to ensure stability.

Secure the bracket to the stud using one wall mount screw (II).

Repeat steps for the other stud.

**GG** L-Bracket x 2



**HH** L-Bracket Screw x 2



**II** Wall Mount Screw x 2

