

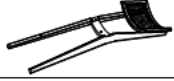













PREPARATION FOR ASSEMBLY

- * Before beginning assembly of product, make sure all parts are present and in good condition.
- * Compare parts with part content list and hardware content list. If any part is missing or damaged, do not attempt to assemble the product.
- * Estimated assembly time: 15 minutes.
- * Tools required for assembly: Allen key (included) and screw driver (not included).

Part List and Hardware List

PIECE	DESCRIPTION	PICTURE	QUANTITY
A	Chair Back		1X
B	Chair Seat		1X
C	Oval Footrest		1X
D	Front Leg-1		1X
E	Front Leg-2		1X
F	Front Rail		1X
HW1	Socket Bolts M6x1.0x40mm		3X
HW2	Socket Bolts M6x1.0x50mm		6X
HW3	Socket Bolts M6x1.0x60mm		2X
HW4	Split Lock Washer 6mm		11X
HW5	Flat Washer 6mm		11X
HW6	Nut 6x1.0xØ8x16mm		2X
HW7	Phillips Screws 4x40mm		4X
HW8	Allen Key		2X

Product Dimensions: 18.5" W x 20.9" D x 46.7"H



! WARNING !

Weight capacity: 275 LBS

Warning: Do not stand on Chair

Warning: Do not over torque Bolts

NOTICE FOR CARE & MAINTENANCE

- * This item should be assembled on a soft surface to prevent scratching the finish during assembly.
- * This item may require periodic tightening.
- * If you are having difficulty, our friendly Customer Care team is always here to help.

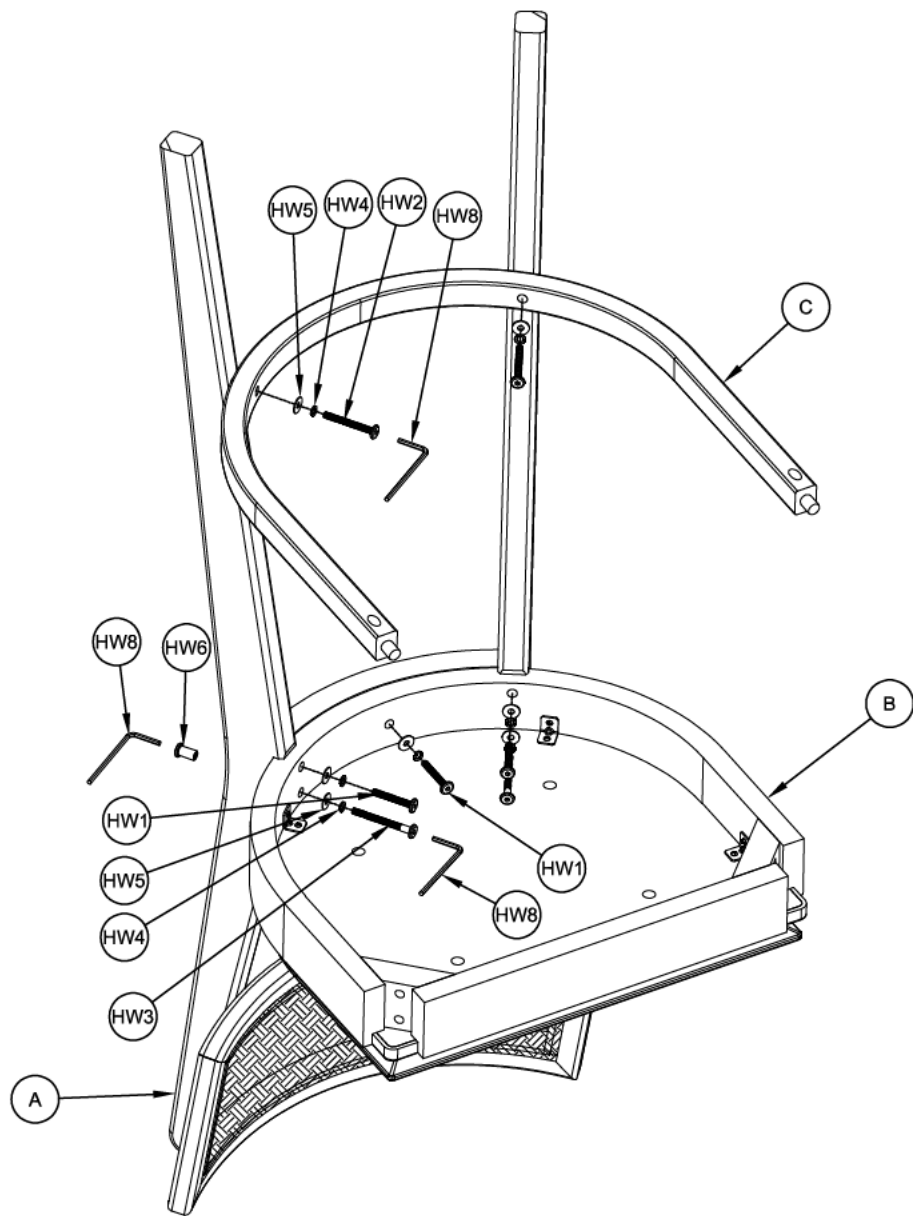

STEP 1: Attach the seat and oval footrest to the chair back. Make sure to apply all the bolts into the holes properly before tightening.

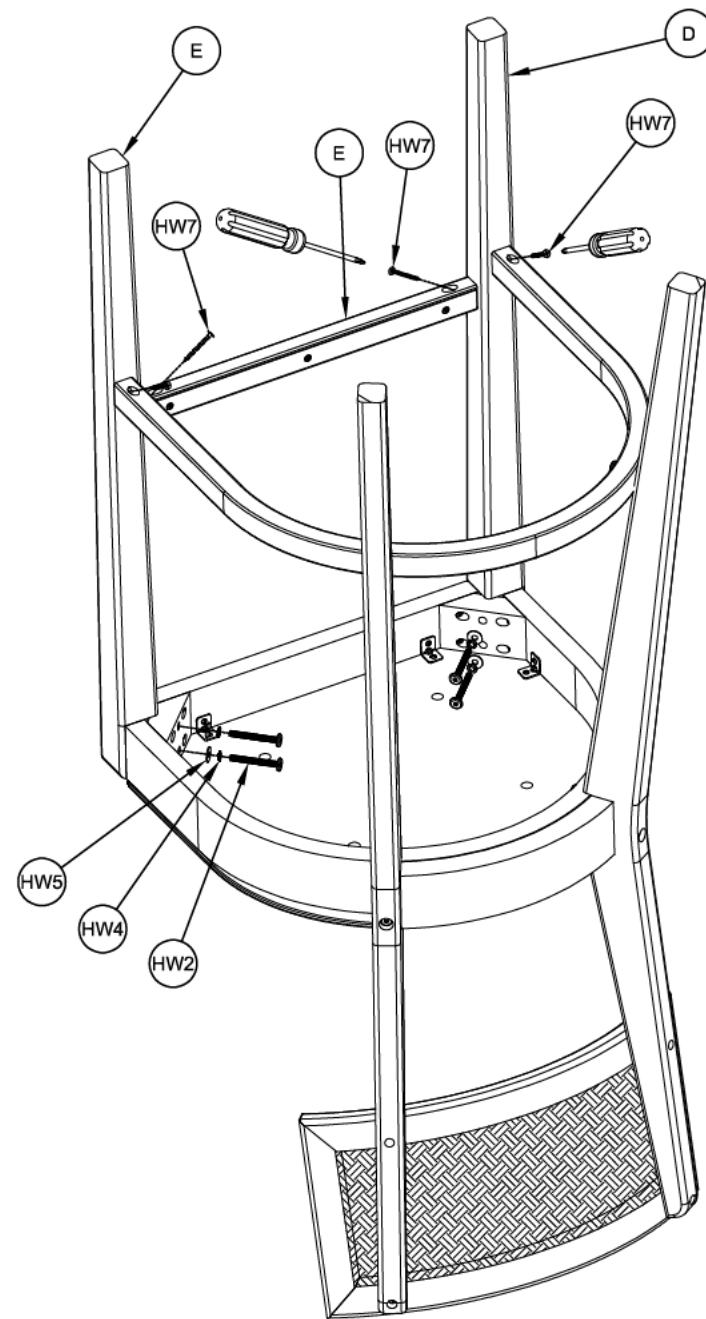

STEP 2: Attach the front legs and the front rail to the seat and oval footrest. Make sure to apply all the bolts and screws into the holes properly before tightening.