

R&D
2019.11.05
DengMark

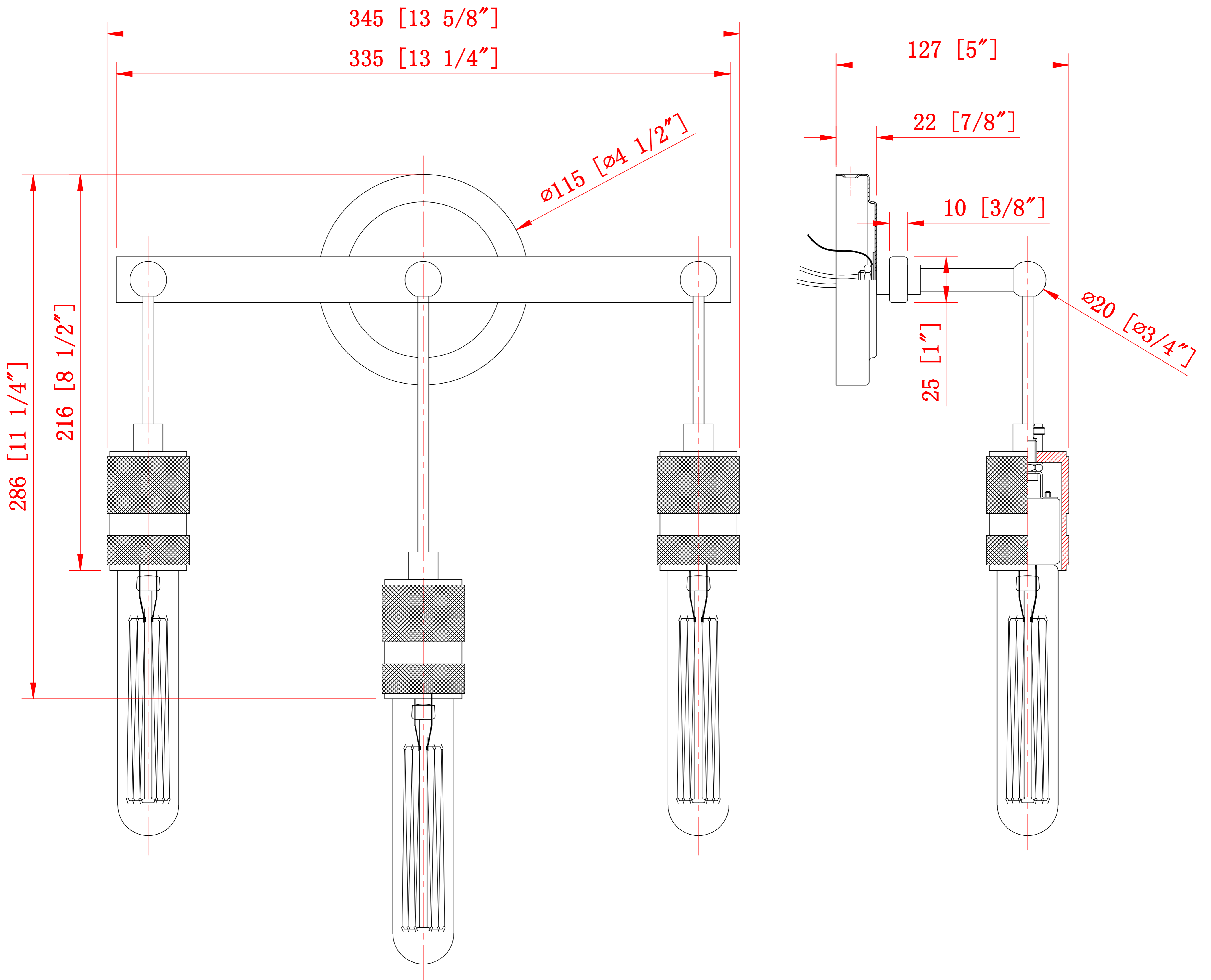

INNOVATIONS LIGHTING
DESIGN COPYRIGHT - 10/30/2019
ALL RIGHTS RESERVED AND MAY
NOT BE DUPLICATED WITHOUT OUR
WRITTEN PERMISSION

ITEM: 444-3W