

Assembly Instructions

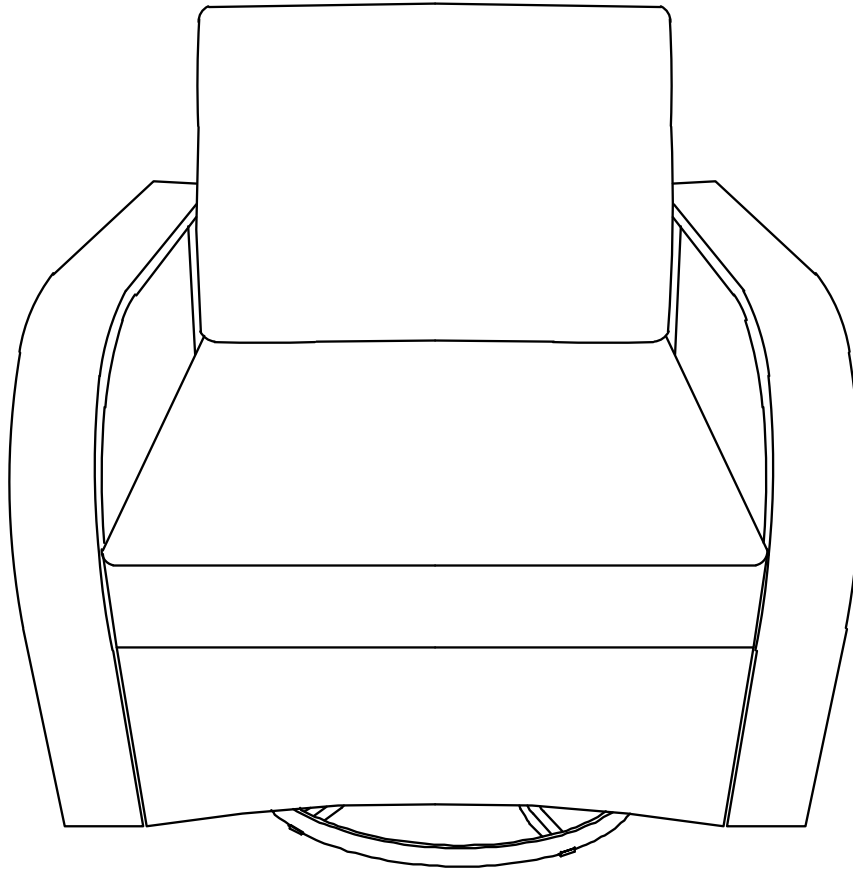











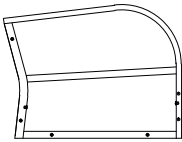

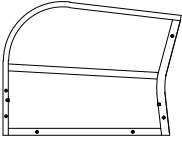

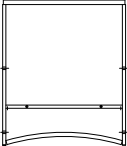
For any missing hardware, damaged parts and other problems.
WELCOME to email us at: service@behousewell.com

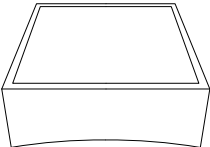
Or call at 1-888-733-8169 Toll free
Between 9AM and 5PM Eastern time, Monday through Friday

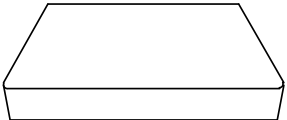
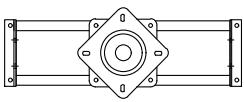
***Don't fully tighten all the bolts till the very end!**

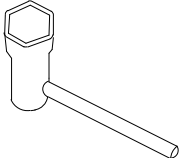
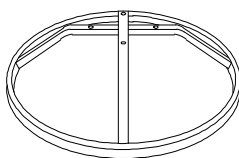

PRE-ASSEMBLY PREPARATION:

- Please read through the instructions before beginning assembly.
- Clear out the space for assembly and lay out all of the parts based on the Parts List, extra room will allow you to easily determine if all the pieces are present.
- Keep small parts and pieces away from children until fully assembled.

Part no.	Part	QTY	Image	Part no.	Part	QTY	Image
A1	Left arm	1		K	Spring washer M6	16	
A2	Right arm	1		L	Nut (M6*40mm)	16	
B	Back	1		M	Washer Ø16*Ø6.5*1	38	
C	Seat	1		N	Allen wrench	1	
D	U-shape fitting with swing arms	2		O	Seat cushion	1	
E	Swivel plate with support bar	1		P	Back cushion	1	
F	Wrench	1					
G	Base	1					
H	Bolt M6*35mm	8					
I	Bolt M6*40mm	14					
J	Bolt (M6*55mm)	4					

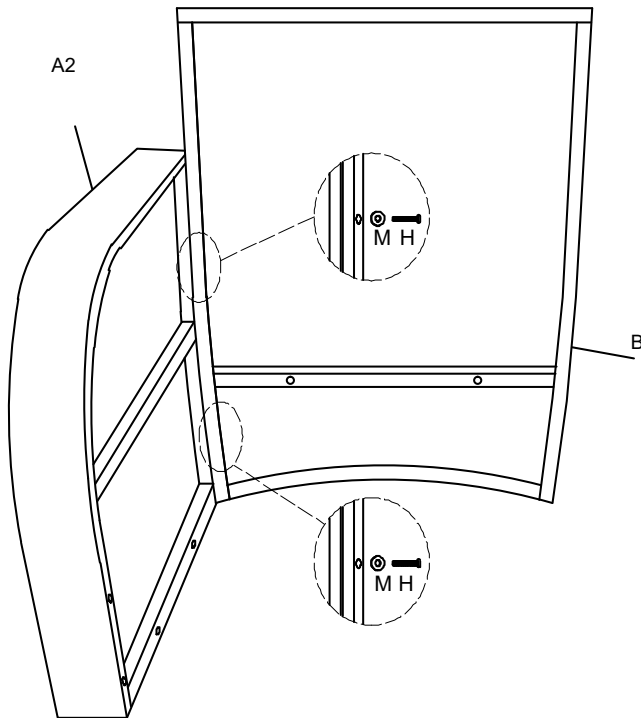

Step 1: Attach right arm A2 to back B with 2pcs bolts H and 2pcs washers M, using Allen wrench N. Note: Don't fully tighten the bolts.



H		M6*35	2
M		M6	2

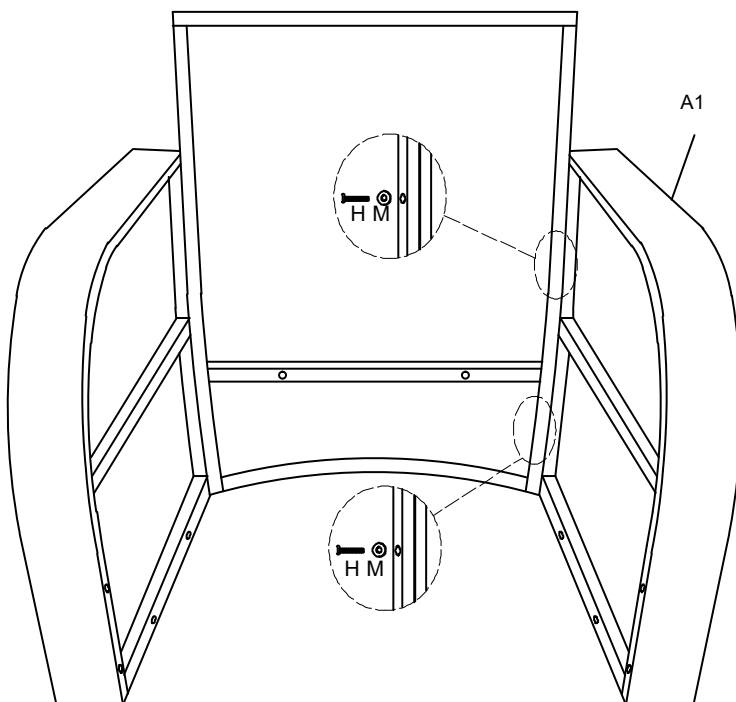

Step 2: Attach left arm A1 to back B with 2pcs bolts H and 2pcs washers M, using Allen wrench N. Note: Don't fully tighten the bolts.



H		M6*35	2
M		M6	2

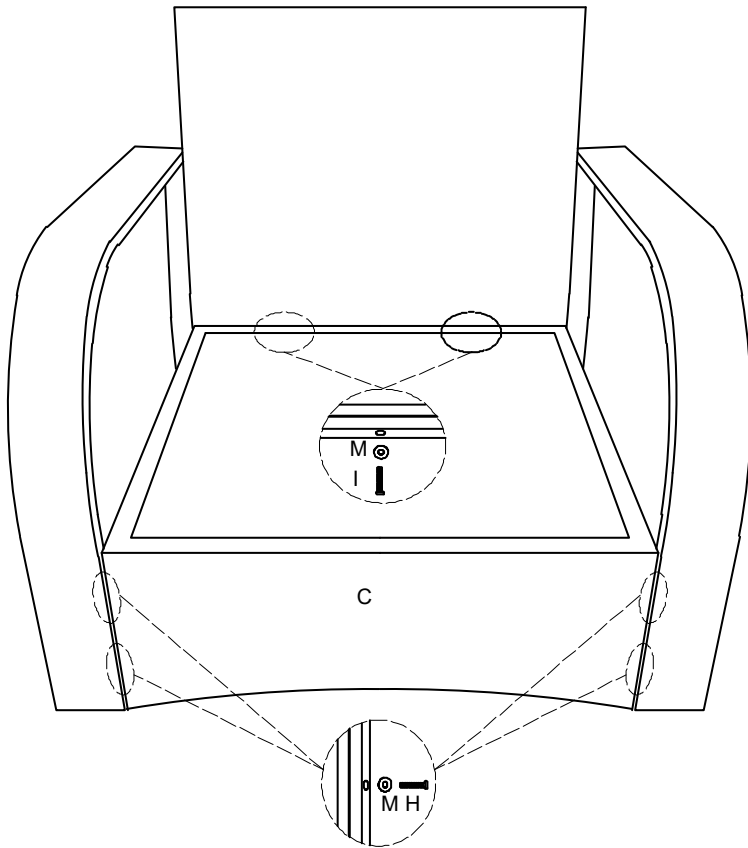



Step 3: Attach seat C to back B and arms A1&A2 with 2pcs bolts I , 4pcs bolts H and 6pcs washers M, using Allen wrench N. Note: Don't fully tighten the bolts.

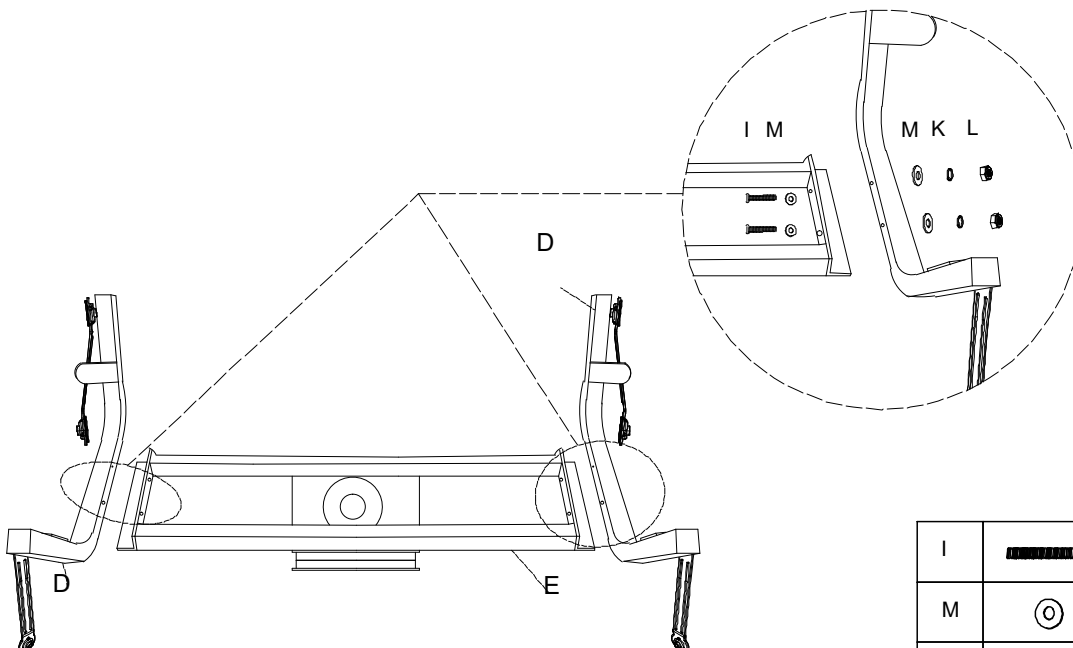

I		M6*40	2
H		M6*35	4
M		M6	6





Step 4: From horizontal direction, attach 2pcs part D to part E with 4pcs bolts I, 8pcs washer M, 4pcs spring washers K, and 4pcs nuts L, using Allen wrench N and wrench F. Note: Don't fully tighten the bolts.

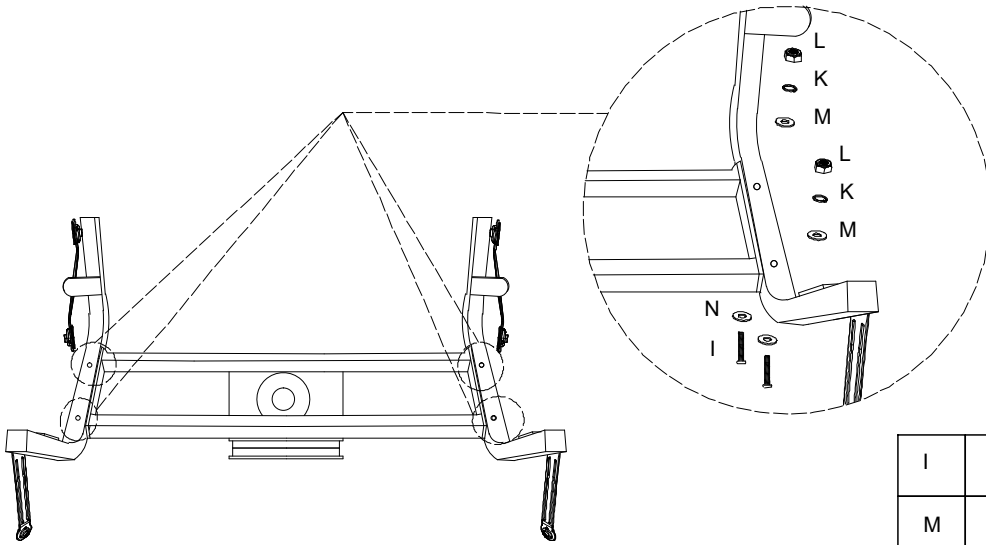

I		M6*40	4
M		Ø16*Ø6.5*1	8
K		M6	4
L		M6	4





Step 5: From vertical direction, attach 2pcs part D to part E with 4pcs bolts I, 8pcs washers M, 4pcs spring washers K, and 4pcs nuts L, using Allen wrench N and wrench F. Note: Don't fully tighten the bolts.

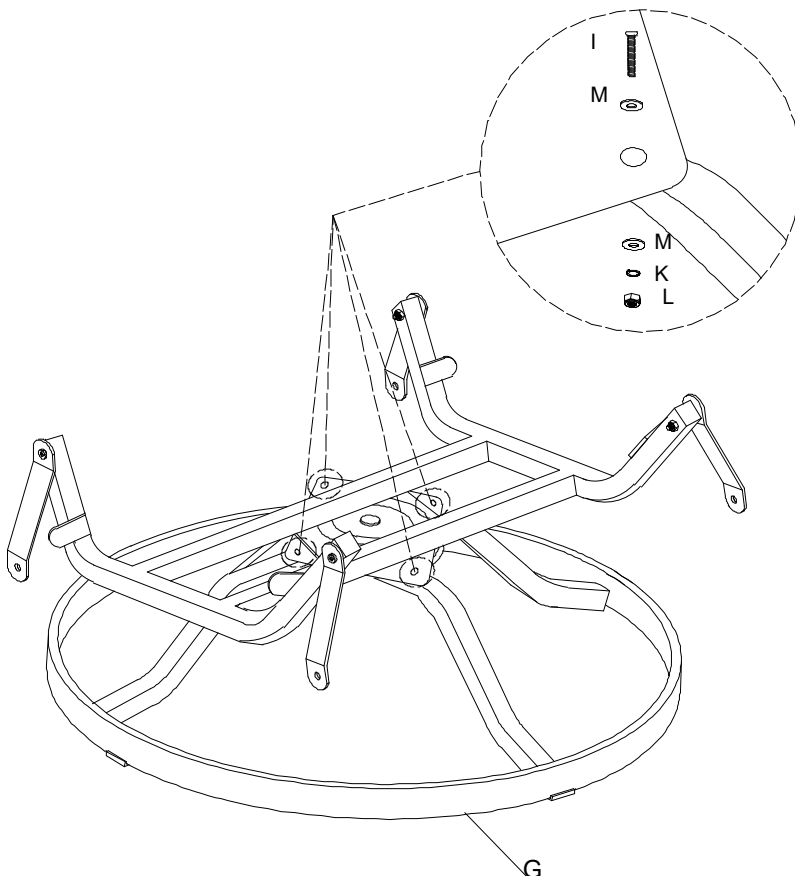

I		M6*40	4
M		Ø16*Ø6.5*1	8
K		M6	4
L		M6	4





Step 6: Attach swivel plate E to base G with 4pcs bolts I, 8pcs washers M, 4pcs spring washers K, and 4pcs nuts L, using Allen wrench N and wrench F. Note: Don't fully tighten the bolts.

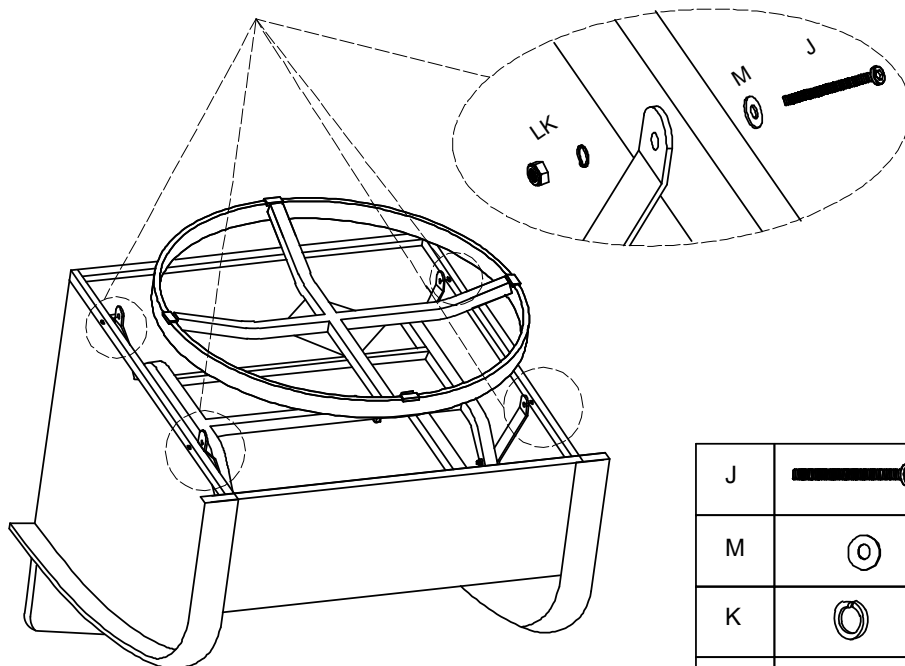

I		M6*40	4
M		Ø16*Ø6.5*1	8
K		M6	4
L		M6	4

Step 7: Attach swing arms D to side panels with 4pcs bolts J, 4pcs washers M, 4pcs spring washers K and 4pcs nuts L, using Allen wrench N and wrench F.
 Note: Please fully tighten all the bolts.



J		M6*55	4
M		Ø16*Ø6.5*1	4
K		M6	4
L		M6	4

Step 8: Put seat cushions O and back cushions P onto the seat.
 Assembly is now complete and the product is ready for use.

