

ASSEMBLY INSTRUCTIONS

TWIN FLOOR BED WITH FENCE

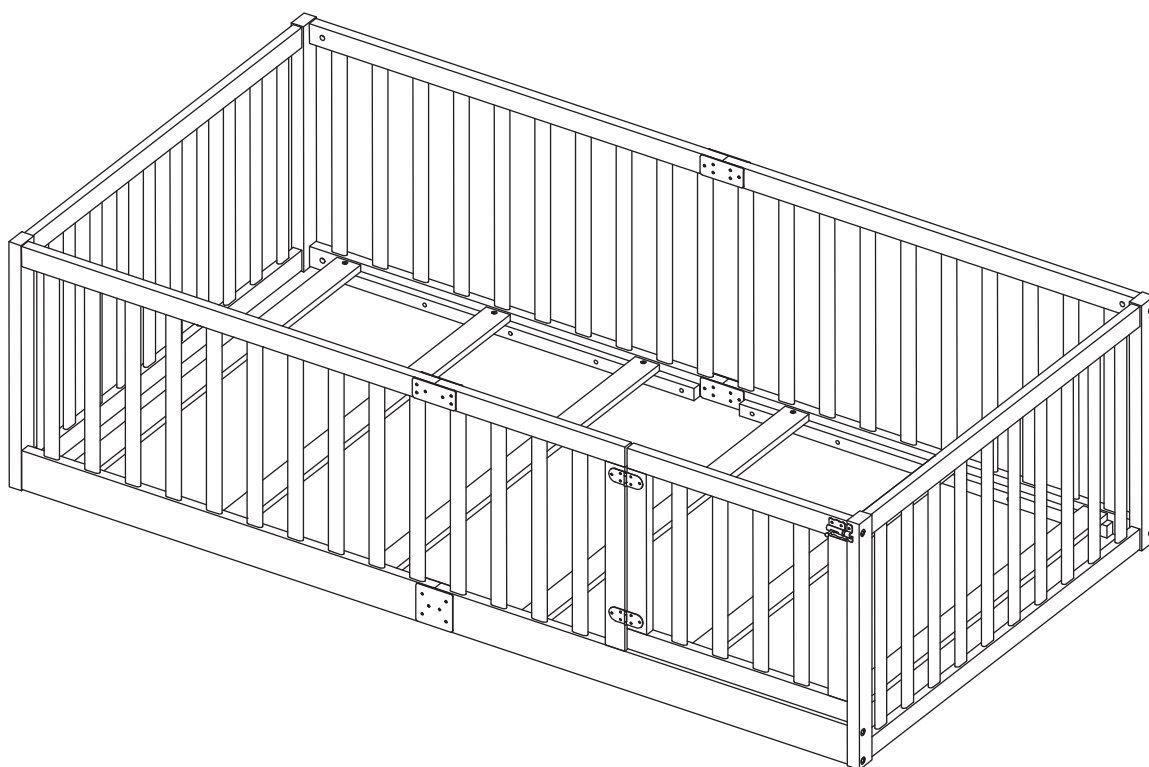

Detail View

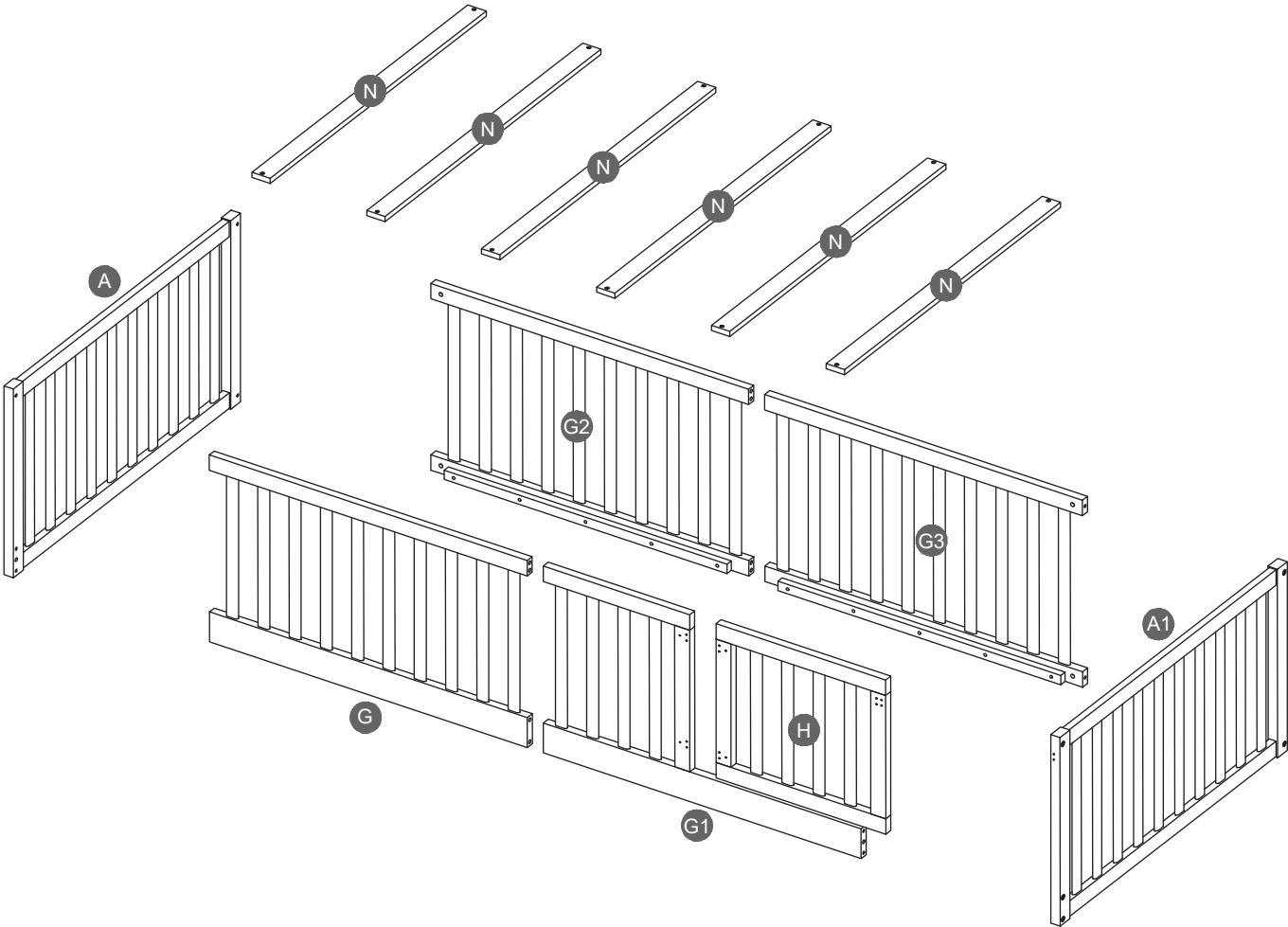

Part List

A

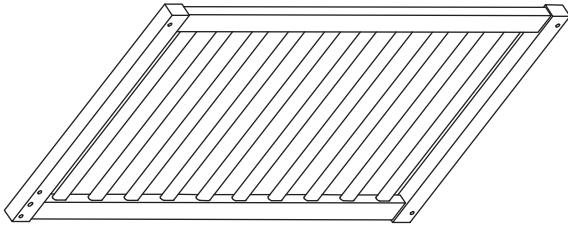

Hb. Fb. Panel (Left) - 1pc

A1

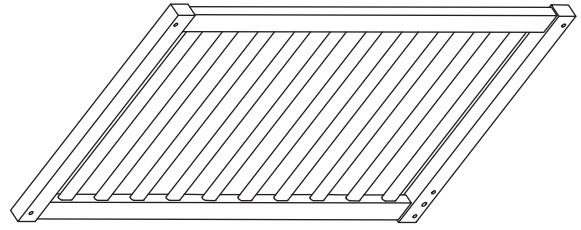

Hb. Fb. Panel (Right) - 1pc

G

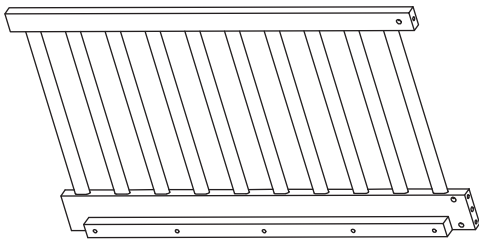

Side Rail Front (Left) - 1pc

G1

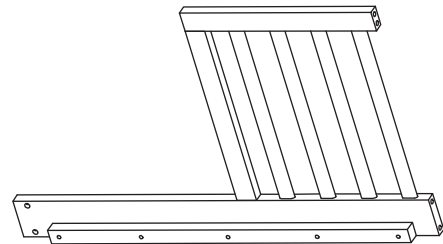

Side Rail Front (Right) - 1pc

G2

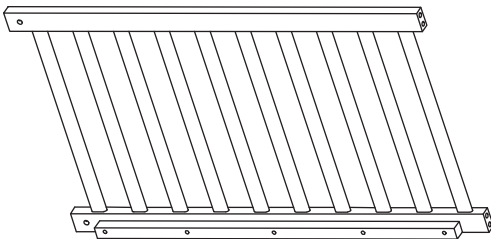

Side Rail Back (Left) - 1pc

G3

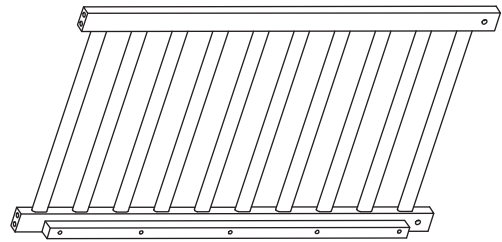

Side Rail Back (Right) - 1pc

H

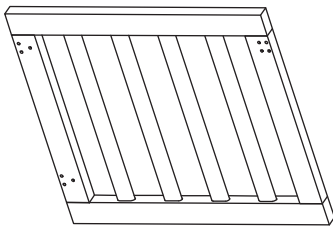





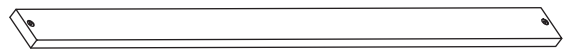



Door - 1pc

N

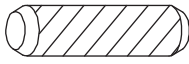
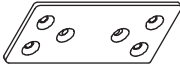
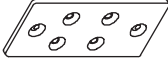
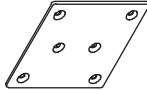
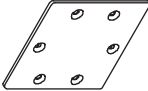

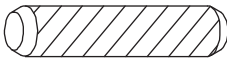
Bed Slats - 6pcs

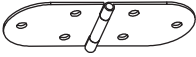
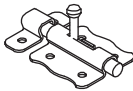
Hardware List

<p>1</p>  <p>M6 x 70mm JCBC (9pcs)</p>	<p>2</p>  <p>M6 x 15mm Barrel Nut (9pcs)</p>	<p>3</p>  <p>M10 x 30mm Wood Dowel (2pcs)</p>
<p>4</p>  <p>100 x 44 x 1.5mm Metal Bracket (3pcs)</p>	<p>5</p>  <p>100 x 44 x 1.5mm Metal Bracket (3pcs)</p>	<p>6</p>  <p>85 x 85 x 1.5mm Metal Bracket (1pc)</p>
<p>7</p>  <p>85 x 85 x 1.5mm Metal Bracket (1pc)</p>	<p>8</p>  <p>M4 x 16mm CSK Screw (48pcs)</p>	<p>9</p>  <p>Sticker Cap (2pcs)</p>
<p>10</p>  <p>M10 x 40mm Wood Dowel (Long) (8pcs)</p>	<p>11</p>  <p>20 x 20 x 290mm Wood Block (1pc)</p>	<p>12</p>  <p>M4 x 25mm CSK Screw (12pcs)</p>
<p>13</p>  <p>46 x 30 x 1.5mm (180°) Hinges (2pcs)</p>	<p>14</p>  <p>10 x 40 x 60mm Lock (1pc)</p>	<p>15</p>  <p>M3.5 x 16mm CSK Screw (18pcs)</p>
<p>16</p>  <p>M4 Allen Key (1pc)</p>		

ASSEMBLY TOOLS REQUIRED (NOT INCLUDED)

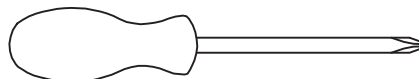

PLEASE BE CAREFUL DO NOT DAMAGE THE HOLE POSITION WHEN YOU USE POWER TOOLS !

STEP 1:

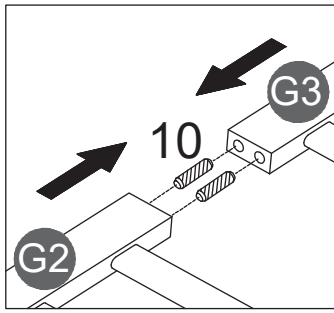

Note:
Use the **Long
Wood Dowel
M10 x 40mm**

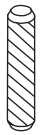

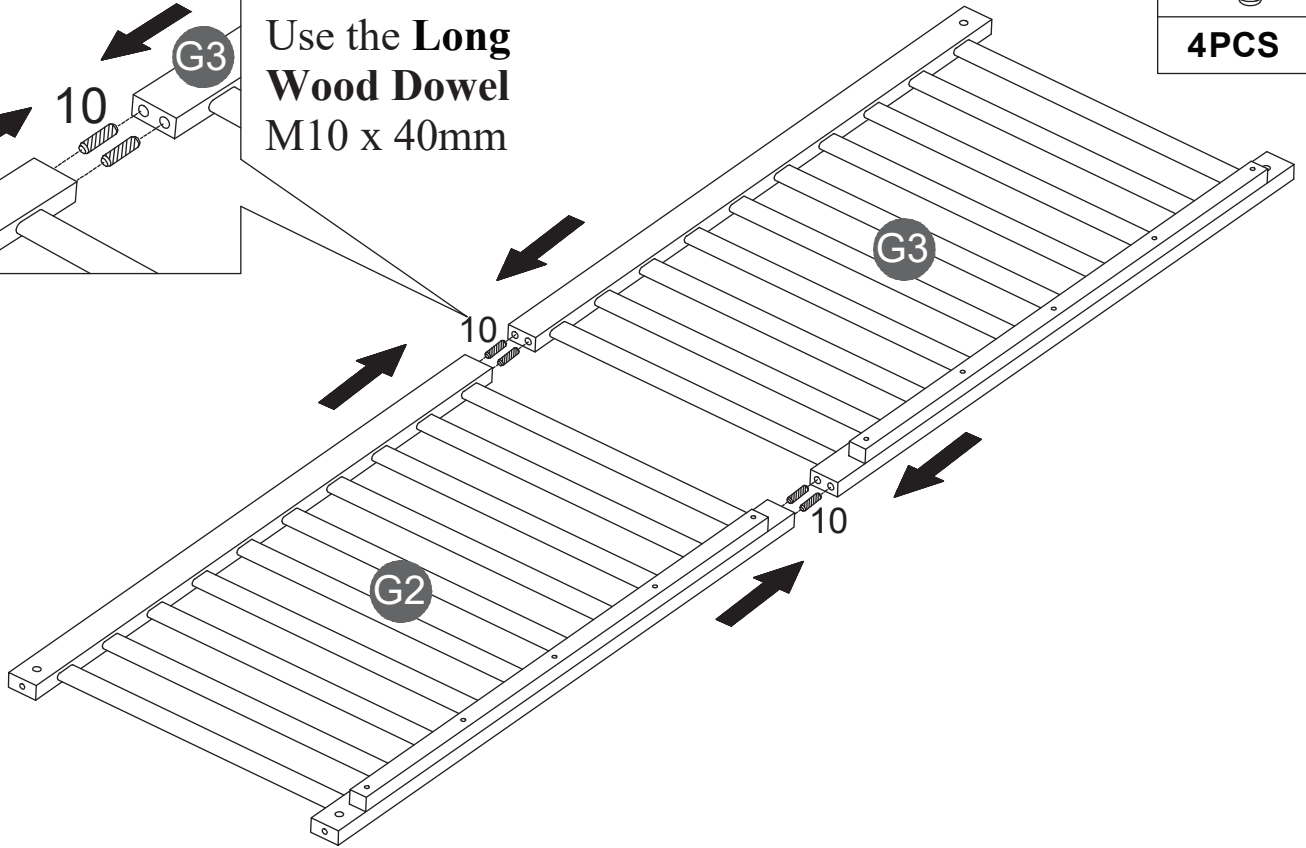
10	
4PCS	

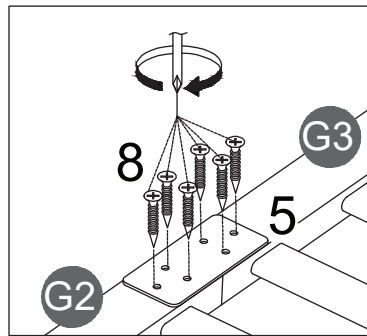

STEP 2:

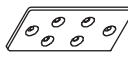

Note:
Use the **Big Head
CSK Screw
M4 x 16mm**

5	8
	
2PCS	12PCS

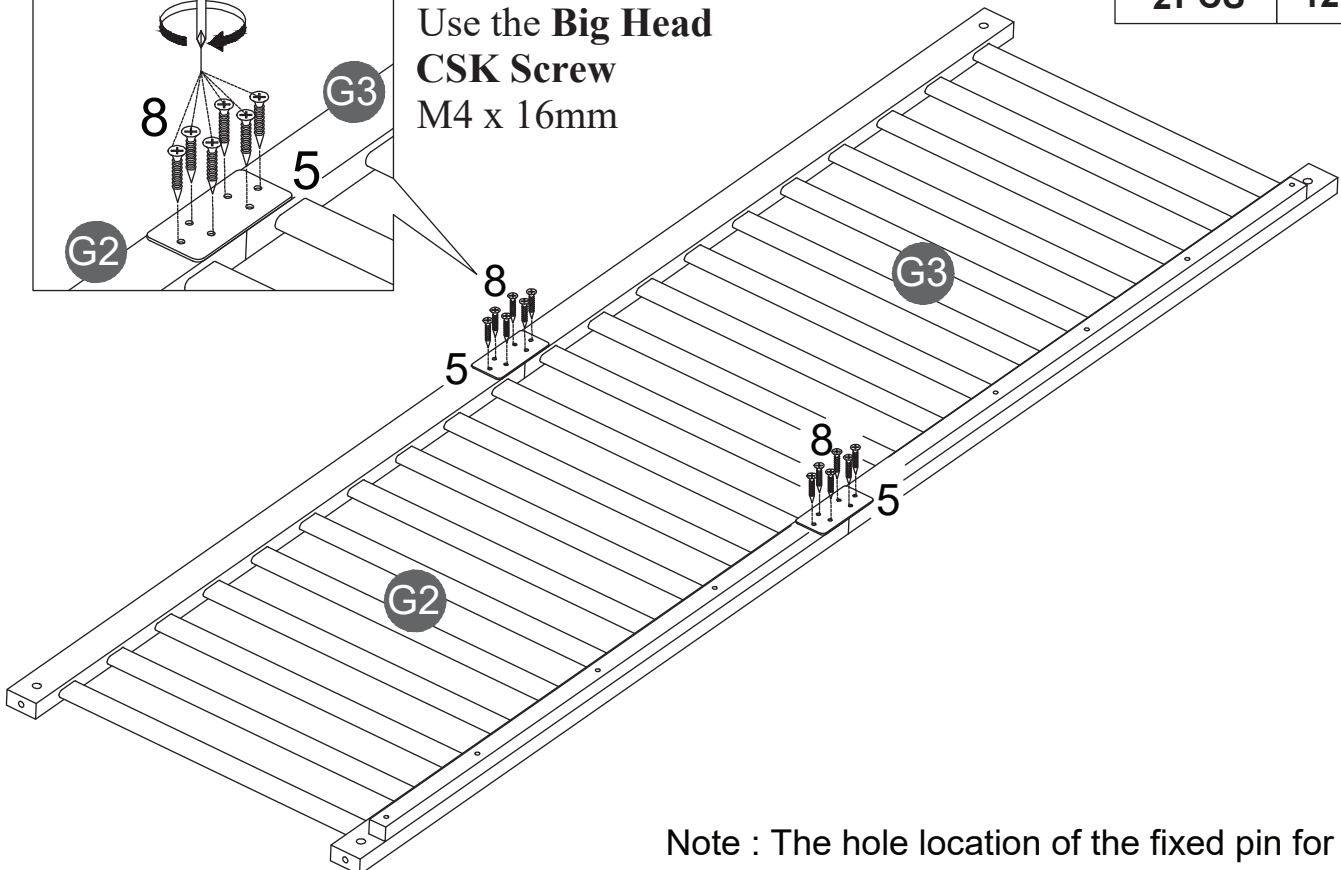

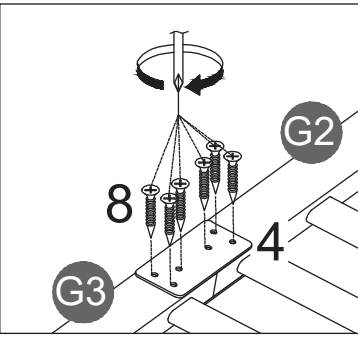

Note : The hole location of the fixed pin for each installation step is different.

STEP 3:



Note:
Use the **Big Head CSK Screw**
M4 x 16mm

4	8
	
2PCS	12PCS

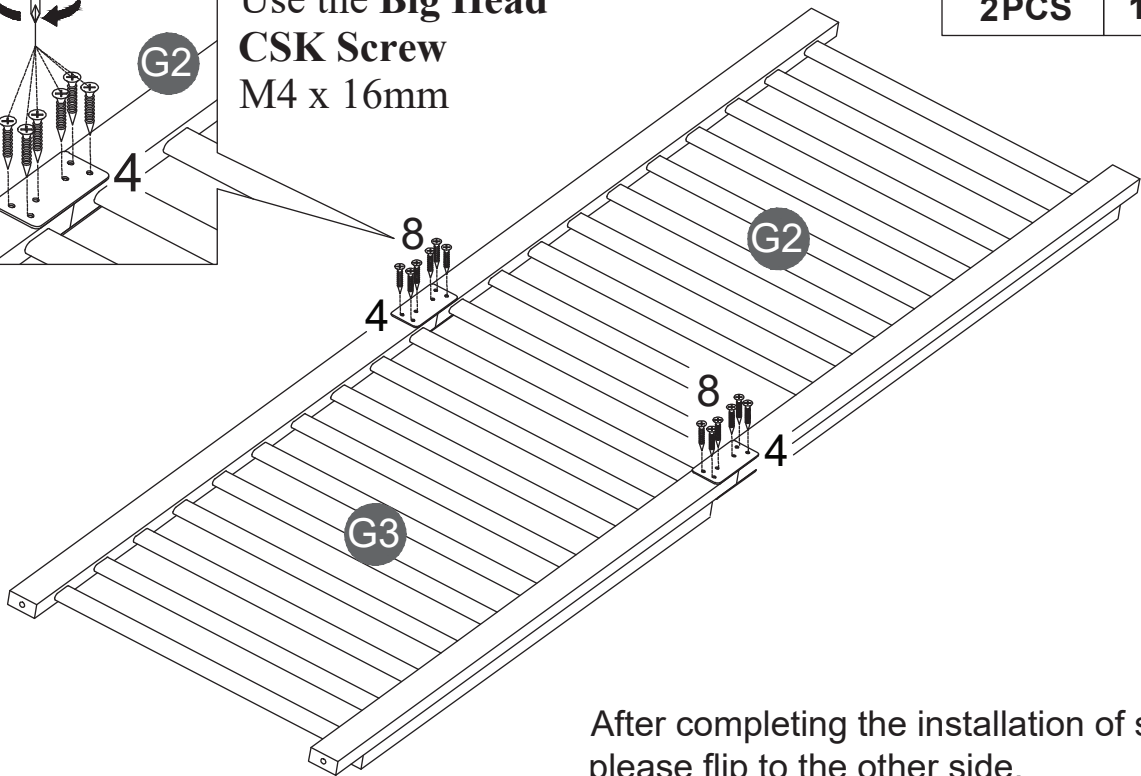

After completing the installation of step 2,
please flip to the other side.

STEP 4:

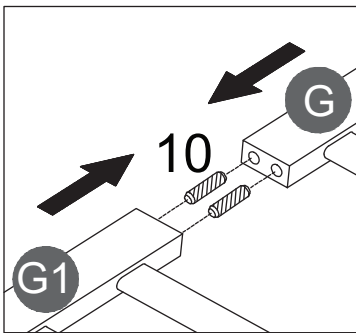

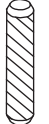

Note:
Use the **Long Wood Dowel**
M10 x 40mm

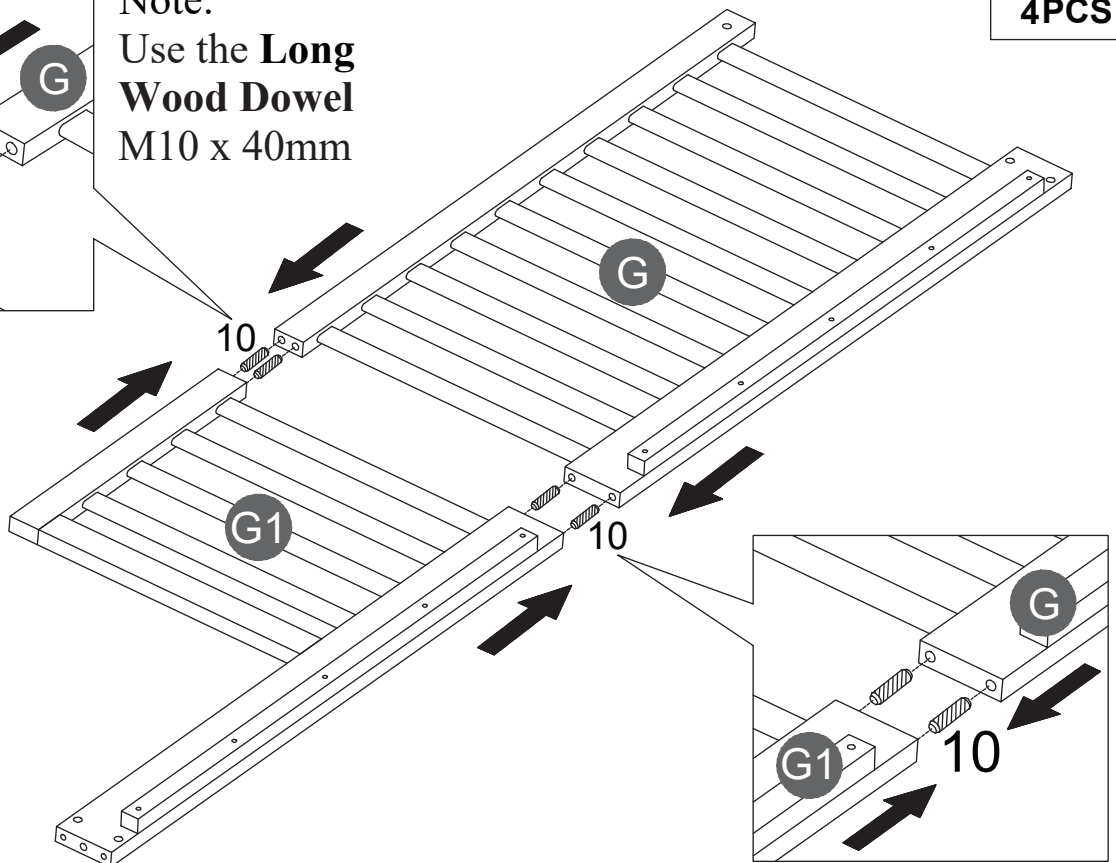
10	
4PCS	

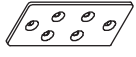
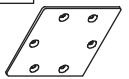

STEP 5:

5 	7 
1PC	1PC
8 	
12PCS	

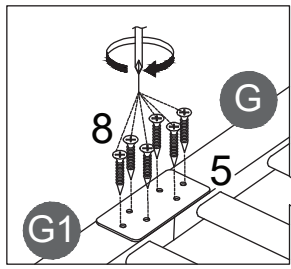

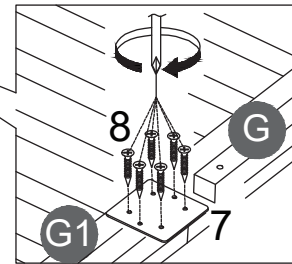
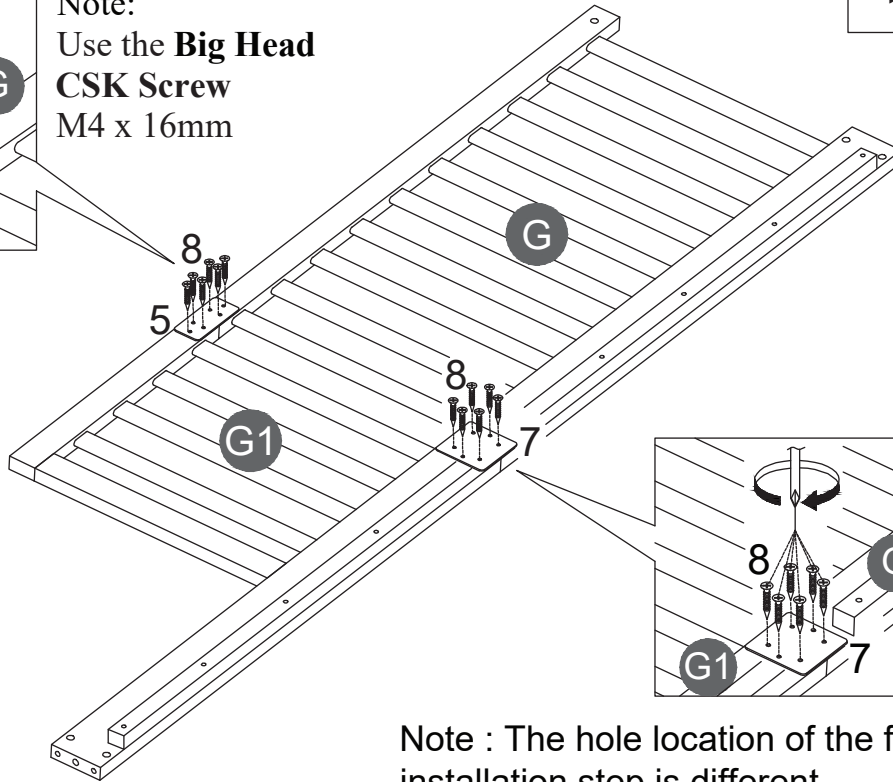

Note:
Use the **Big Head CSK Screw**
M4 x 16mm

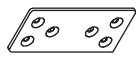
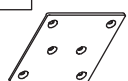

Note : The hole location of the fixed pin for each installation step is different.

STEP 6:

4 	6 	8 
1PC	1PC	12PCS

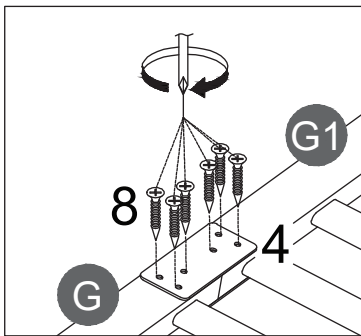



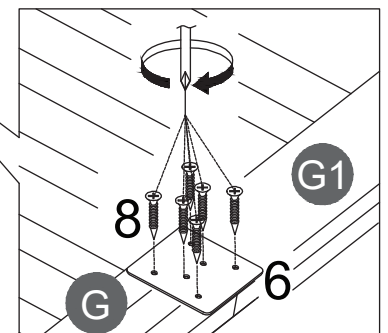
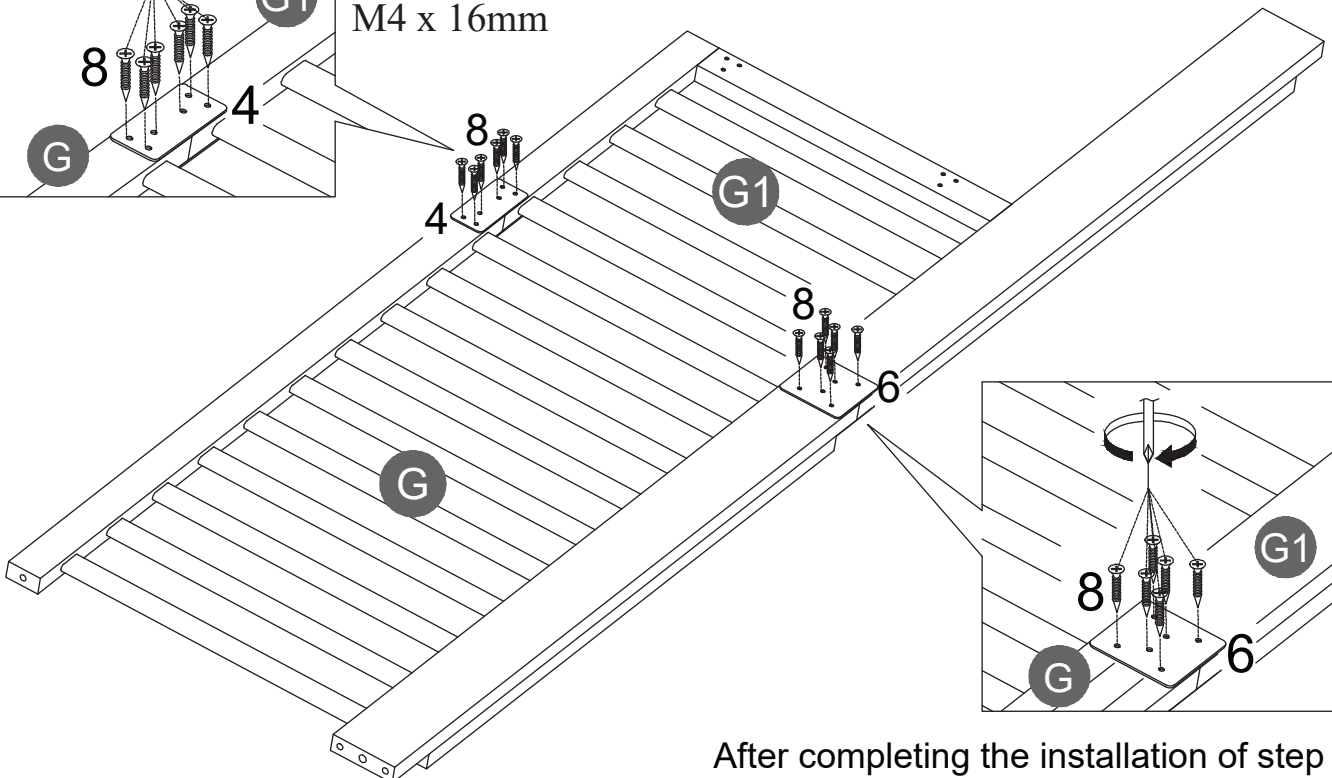

Note:
Use the **Big Head CSK Screw**
M4 x 16mm



After completing the installation of step 5,
please flip to the other side.

STEP 7:

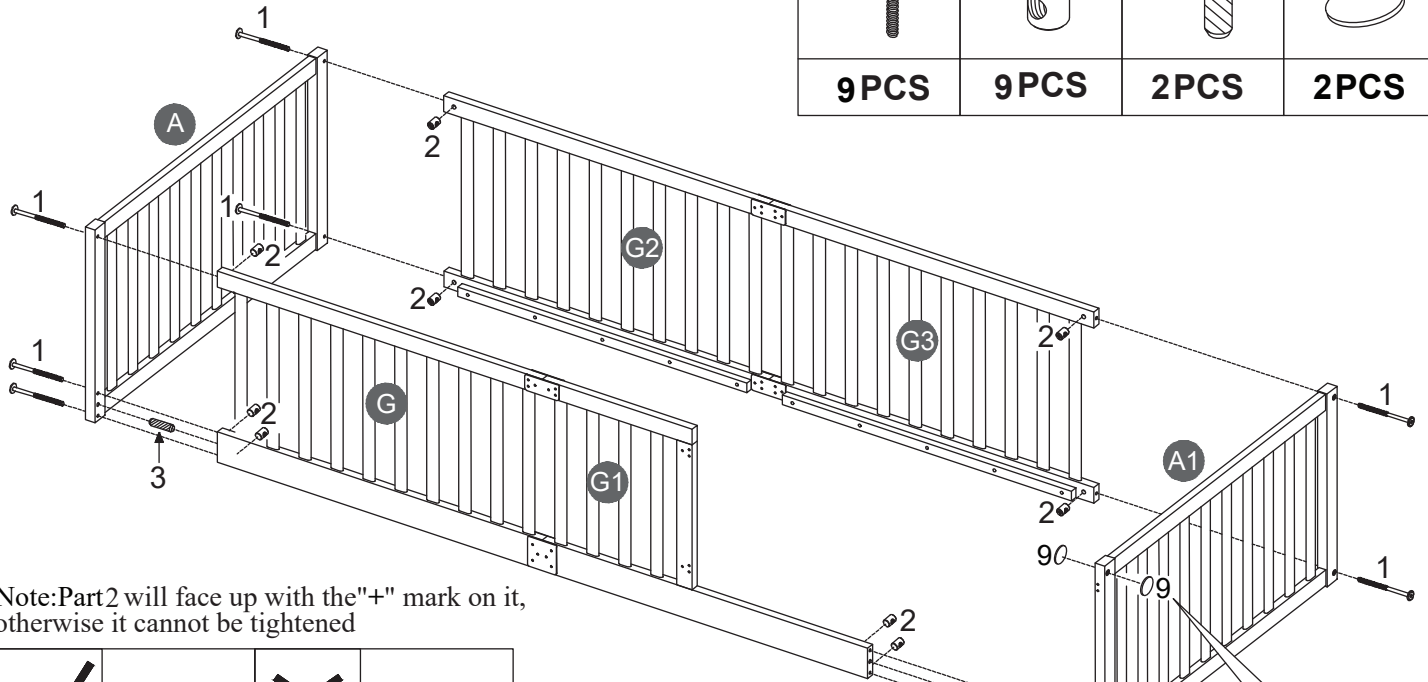

1		2		3		9	
9PCS		9PCS		2PCS		2PCS	

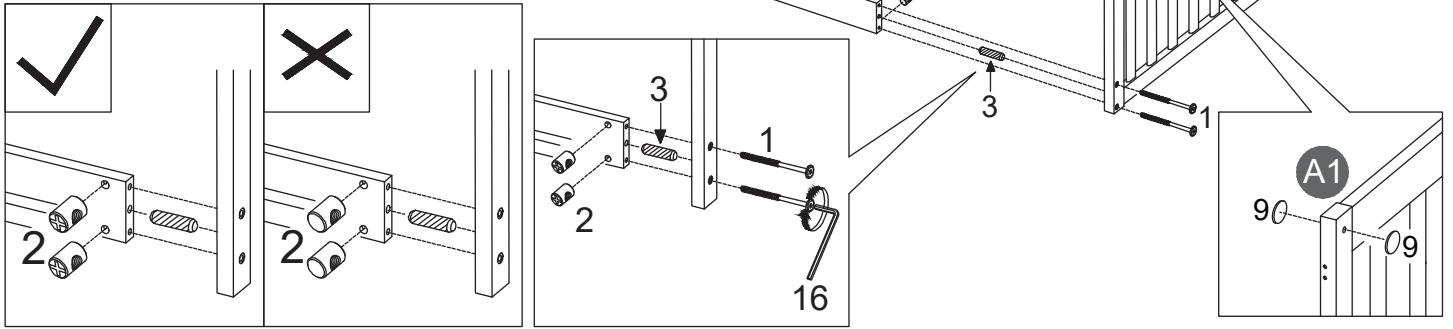

Note: Part 2 will face up with the "+" mark on it, otherwise it cannot be tightened

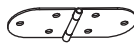
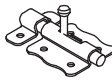

STEP 8:

13		14		15	
2PCS		1PC		10PCS	

Note:
Use the **Small Head CSK Screw**
M3.5 x 16mm

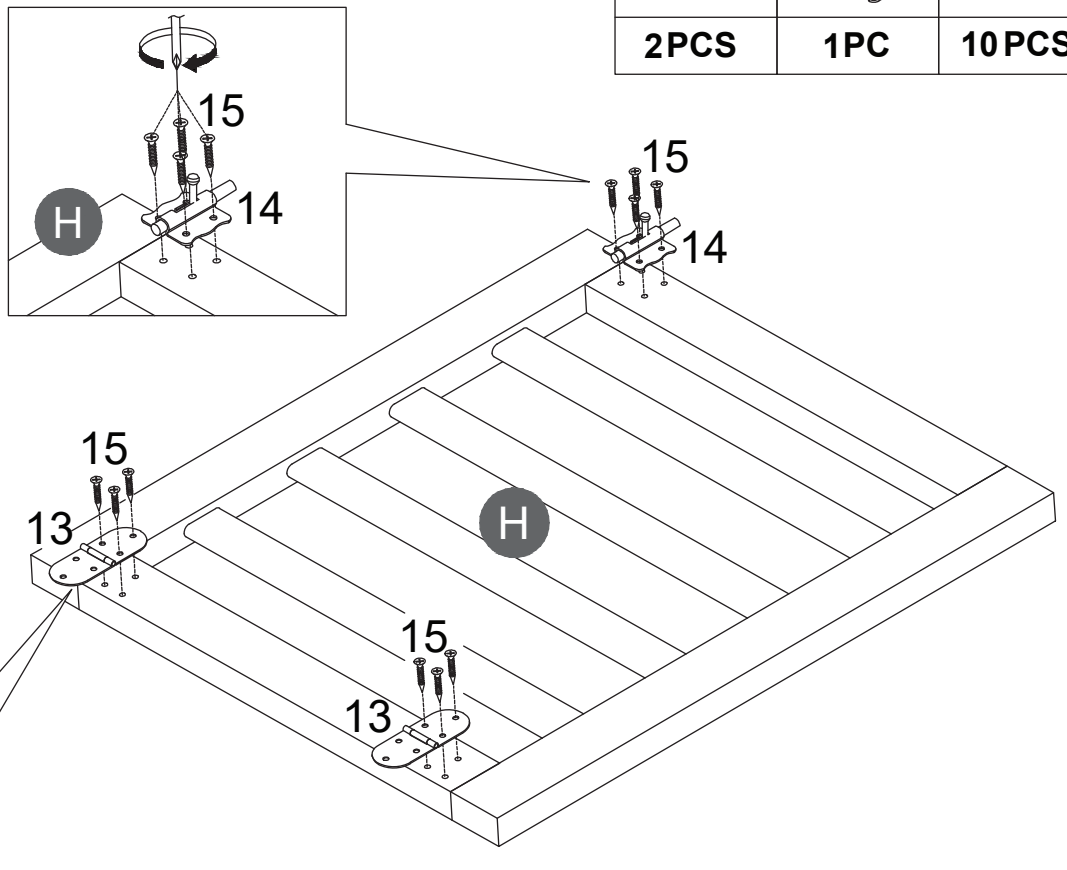

STEP 9:

15



8 PCS

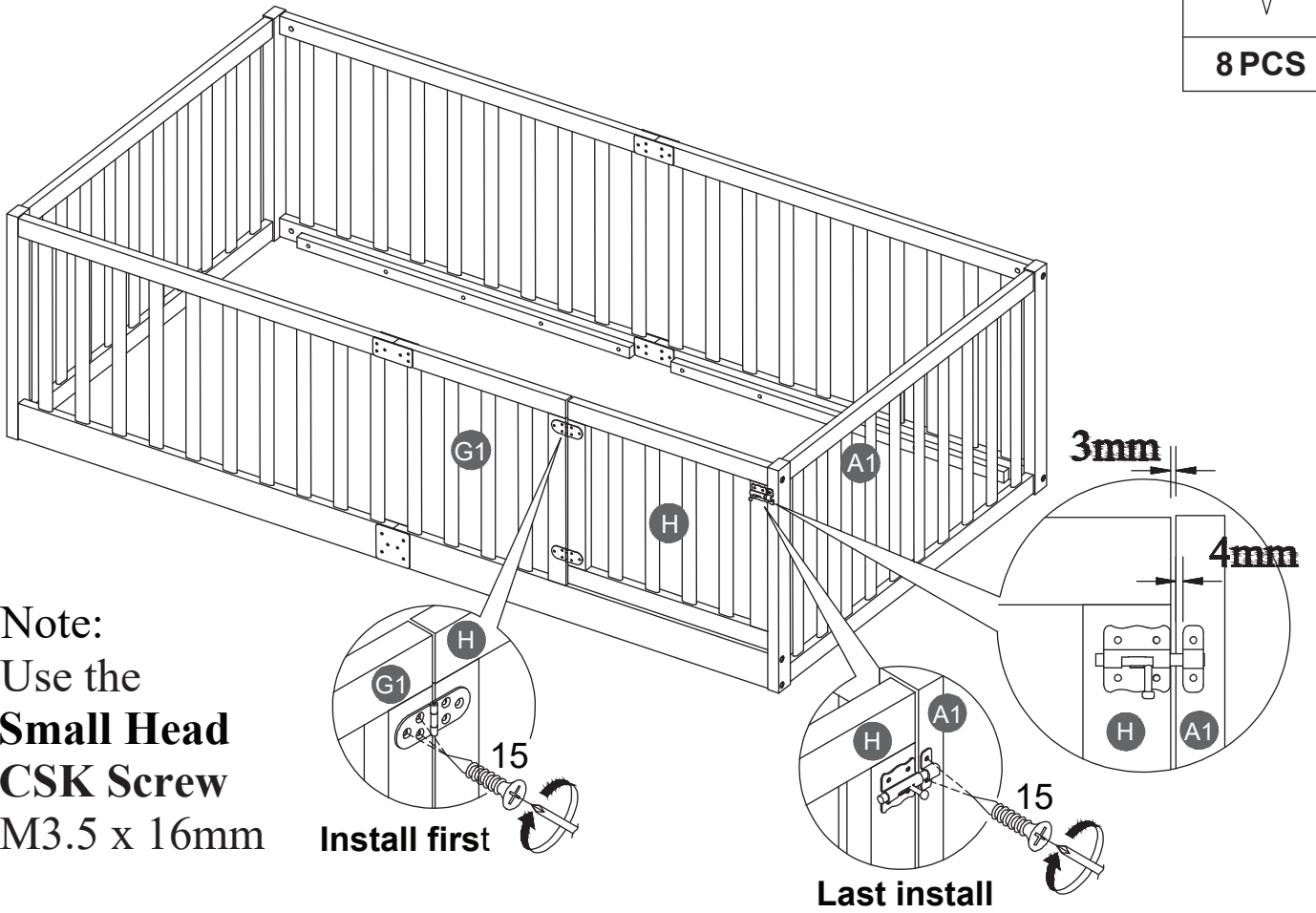

Note:
Use the
**Small Head
CSK Screw**
M3.5 x 16mm



Install first

Last install

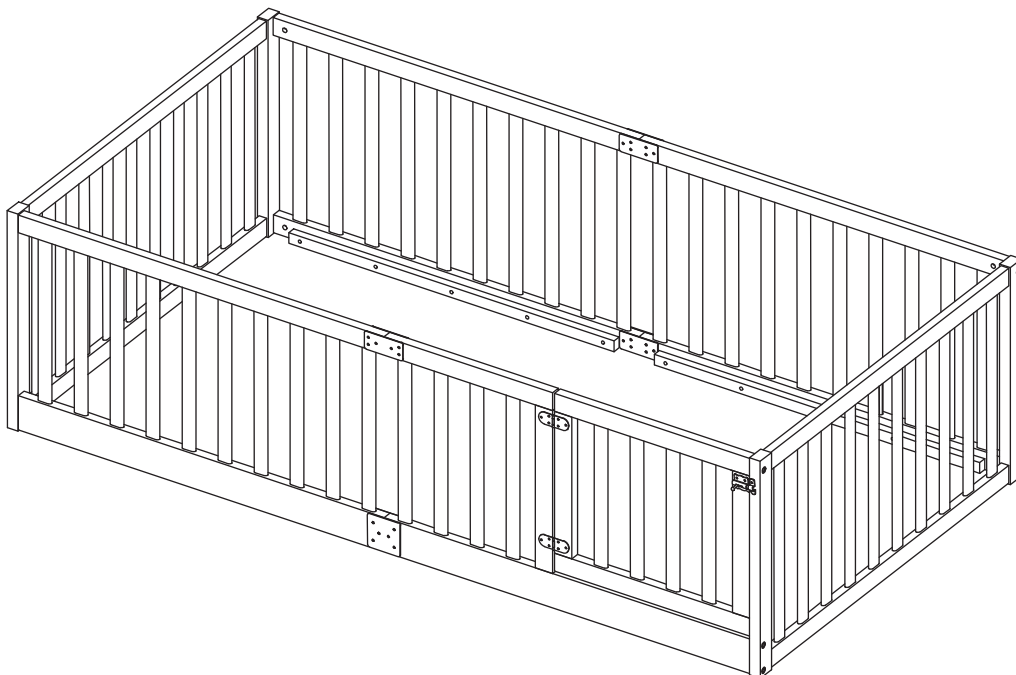
Please completing the installation of the hinge first,
and then fix the barrel bolt lock



STEP 10:

11	12
	
1PC	12PCS

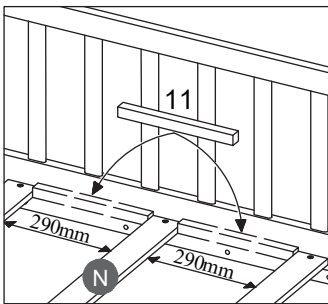
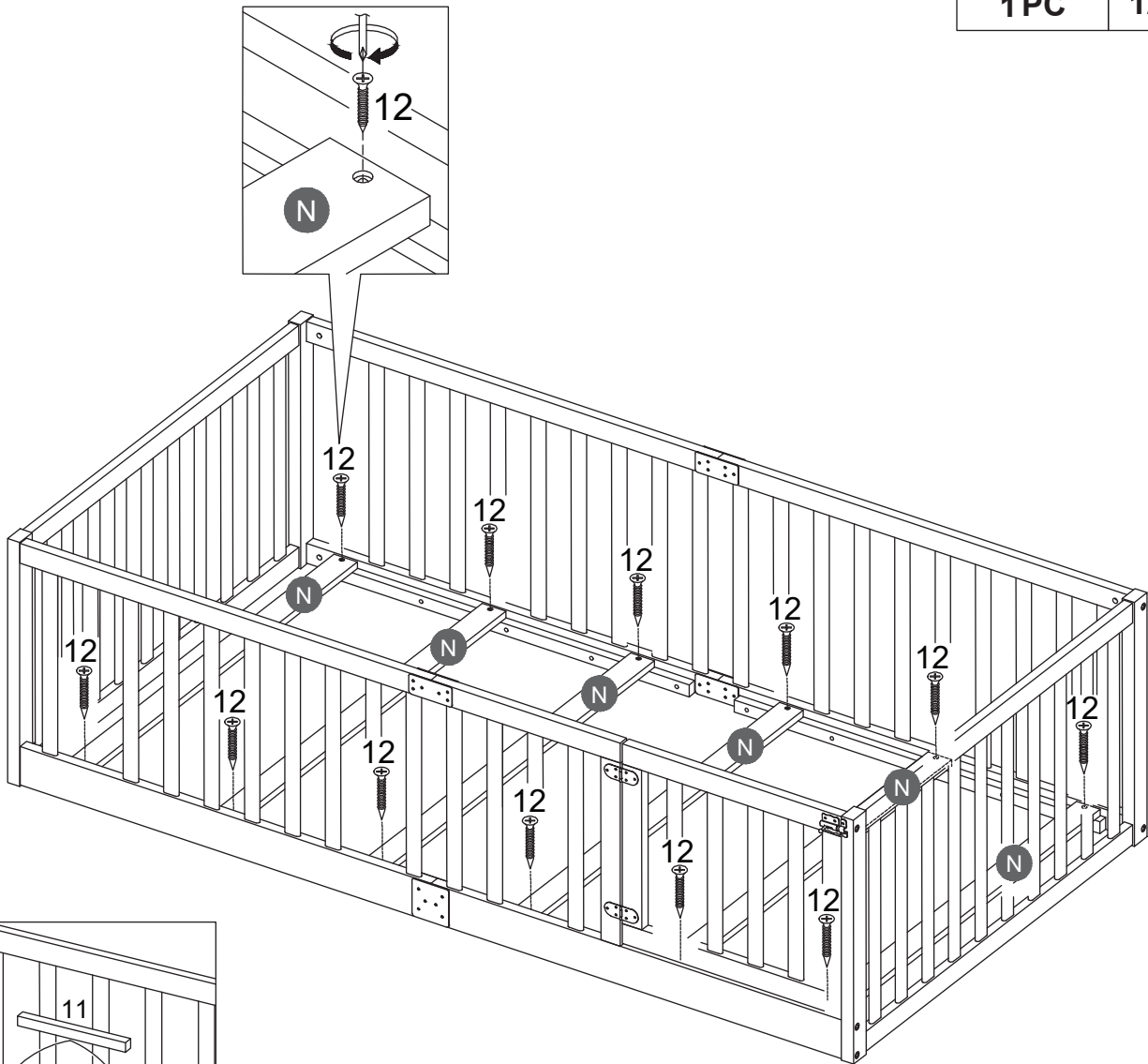

Note: Use Wood Block as a guidance distance between Bed Slats.

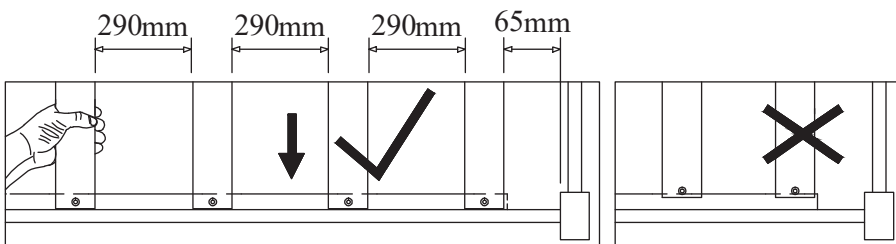

Note: Do not lock the screws of the bed slats to the outermost edge of the bed slats, you need to leave a certain space at the edges, otherwise it will cause the board to break. Do not lock the bed slats on the edge of the wood, please hold firmly before screwing, hold it in place with one hand, then lock the screw.