

Assembly instructions for step 1/3:

- Tools:** A screwdriver is shown as the required tool. A power drill is shown with a diagonal line through it, indicating it is not to be used.
- Warning:** A warning triangle with an exclamation mark is positioned above the tool icons.
- Time:** A clock icon is shown with the text "10'" below it, indicating a 10-minute assembly time.
- Personnel:** A person icon is shown with the number "1" below it, indicating that one person is required for assembly.
- Diagram:** A diagram shows a rectangular block being placed on a surface with a textured pattern. A second diagram shows the block being pushed down, with a diagonal line through it, indicating that the block should not be pushed down.

A

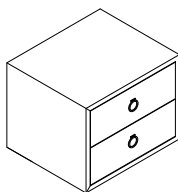

x 1

B

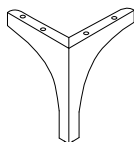

x 4

C

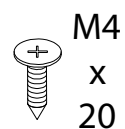

x 16

A

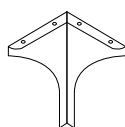
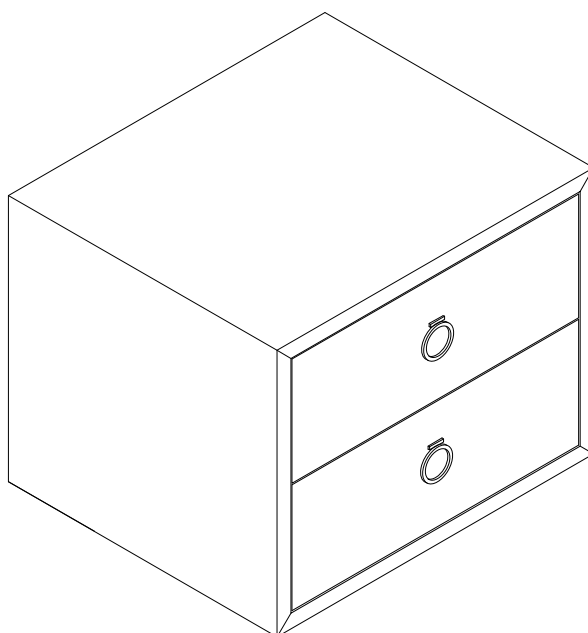

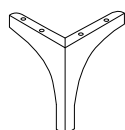
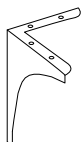

B x 4

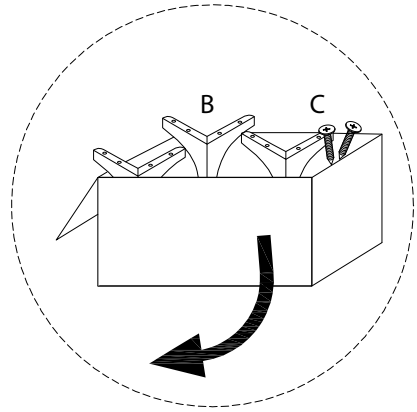
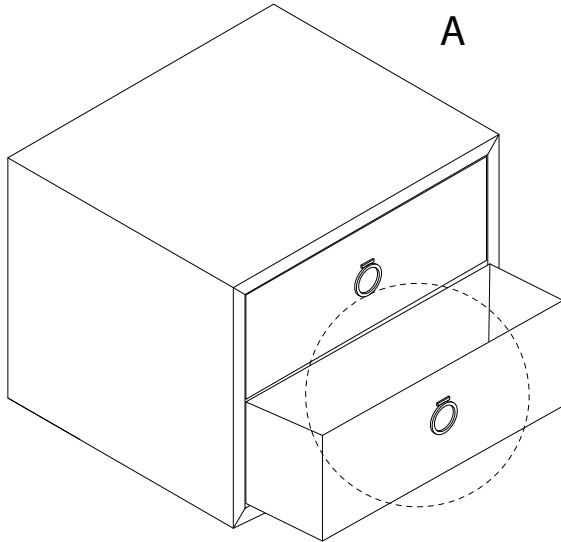

!

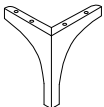

1

<p>A</p>  <p>x 1</p>	<p>B</p>  <p>x 4</p>	<p>C</p>  <p>M4 x 20 x 16</p>
---	---	--

