

## INSTALLATION AND OPERATION INSTRUCTIONS

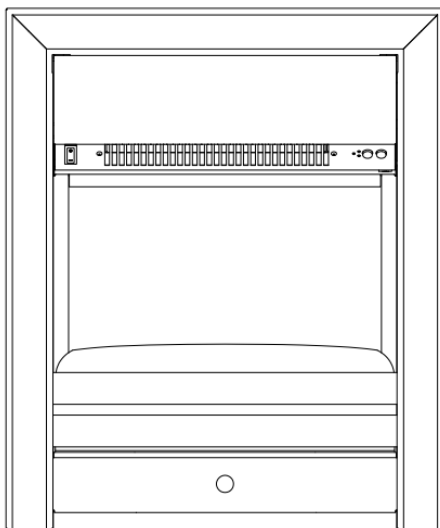

**Please read the instructions carefully before installation or use and keep for future reference**

# CONTENTS

1. Important Safety Information.....	1
2. Technical Specifications.....	3
3. Parts and Hardware.....	4
4. Appliance Dimensions.....	5
5. Installation Instructions.....	5
6. Operating Instructions.....	6
6a. Manual Control Panel.....	7
6b. Remote Controls.....	8
7. Maintenance.....	14
8. Others.....	16

## 1. IMPORTANT SAFETY INFORMATION

- 1.1 **Read all of the instructions carefully before using the appliance.**
- 1.2 **For indoor use only.** This appliance is not suitable for use outside the house and **only suitable for well insulated spaces or occasional use.**
- 1.3 Do not use this appliance in the immediate surroundings of a bath, a shower or a swimming pool.
- 1.4 Do not use this fire as a free-standing appliance. It must always be fixed to the wall, fireplace mantel, floor etc.
- 1.5 This fire must not be located immediately below a socket-outlet.
- 1.6 This appliance must be earthed.
- 1.7 This appliance must not be supplied through an external switching device, such as a timer, or connected to the circuit that is regularly switched on and off by utility in order to avoid a hazard due to the inadvertent resetting of the thermal cut out.
- 1.8 If the power cord is damaged, it must be repaired by the manufacturer, its authorised service centre or professional person.
- 1.9 **DO NOT COVER.** Warning: in order to avoid overheating, do not allow the appliance to be covered or let the air inlet/outlet become obstructed.

- 1.10 To reduce the risk of fire, keep textiles, curtains, or any other flammable material a minimum distance of **1 meter** from the air outlet.
- 1.11 Keep the power cord away from hot surfaces and hot conditions. Do not route the power lead in front of the appliance.
- 1.12 Do not use this fire in rooms that have explosive fumes in them (for example petrol), or if you are using solvents, glue, aerosol spray or in flammable paints, as these may catch fire.
- 1.13 This appliance can be used by children aged from 8 years and above and persons with reduced physical, sensory or mental capabilities or lack of experience and knowledge if they have been given supervision or instruction concerning use of the appliance in a safe way and understand the hazards involved.
- 1.14 Children and vulnerable people must be supervised at all times when using this appliance, as some parts can become very hot and cause burns.
- 1.15 Do not use this appliance in small rooms when they are occupied by persons not capable of leaving the room on their own, unless constant supervision is provided.
- 1.16 Children aged between 3 and 8 years old should only switch on/off the appliance provided that it has been placed or installed in its intended normal operating position and instructions and supervision concerning the safe usage of the appliance are given.

1.17 Cleaning and user maintenance shall not be made by children without supervision.

1.18 This appliance shall not be played with by children.

1.19 Children of less than 3 years should be kept away unless continuously supervised.

1.20 Keep the power plug accessible after installation.

**Information below for authorized person or service centre only:**

A non-rewireable plug fitted with a 13A fuse is supplied. Should the fuse or plug need replacing, it must be replaced with a 13A fuse or plug being 13A BS1363A approved.

## 2. TECHNICAL SPECIFICATIONS

Model No.: E112R

Supply Voltage: AC 220-240V 50Hz

Maximum power consumption: 2KW

Power for flame effect: 6W (LED 2W + Motor for flame 4W)

### **Heat Output:**

Nominal heat output (Pnom): 2KW

Minimum heat output(indicative) (Pmin): 1KW

Maximum continuous heat output (Pmax): 2KW

### **Auxiliary Electricity Consumption:**

At nominal heat output (elmax): 12.5W

At minimum heat output (elmin): 12.0W

In standby mode (elSB): 0.49W

### Type of heat output / room temperature control



Single stage heat output and no room temperature control	No
Two or more manual stages, no room temperature control	No
With mechanic thermostat room temperature control	No
With electronic room temperature control	Yes
Electronic room temperature control plus day timer	Yes
Electronic room temperature control plus week timer	Yes

### Other Control Options

Room temperature control, with presence detection	No
Room temperature control, with open window detection	Yes
With distance control option	No
With adaptive start control	Yes
With working time limitation	No
With black bulb sensor	No

## 3. PARTS AND HARDWARE

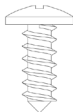
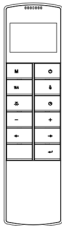
- 3.1 Unpacking the fire carefully, make sure that the appliance is intact with no signs of damage caused by transport and no part has been exposed to water. If in doubt, do not use the appliance and contact an authorised service centre.
- 3.2 Keep plastic wrapping away from children.
- 3.3 Save the original packaging as this may be required in the event of service complaint with product.
- 3.4 Check that all parts are removed from the packing.

 <p>ST 4*12 Screws (2)</p>	 <p>Remote Handset (1)</p>	 <p>AAA Battery (2)</p>	 <p>Instruction (1)</p>
---	---	--	--

## 4. APPLIANCE DIMENSIONS

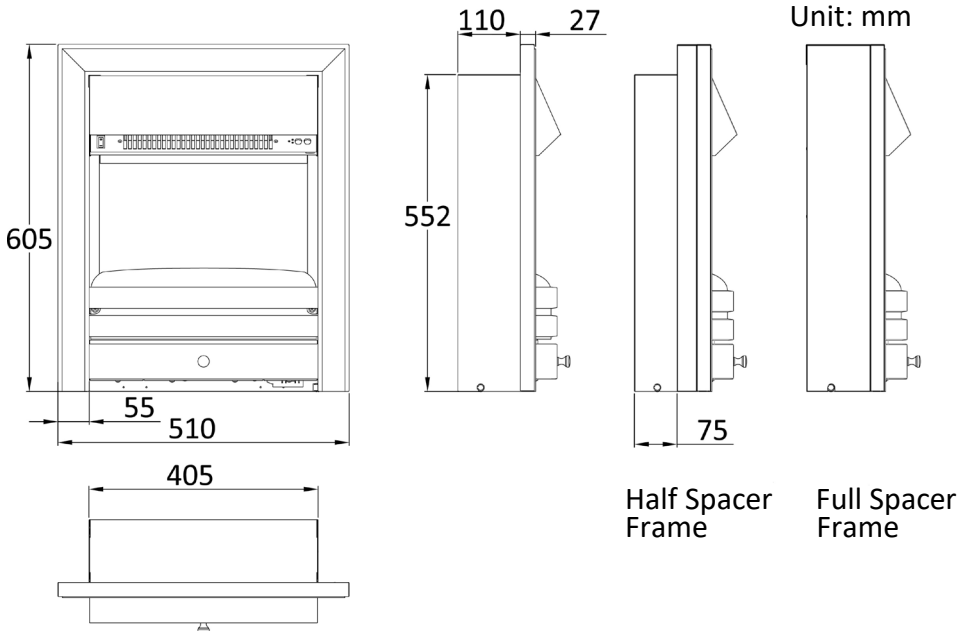

## 5. INSTALLATION INSTRUCTIONS

### Tools Required

A screw driver will be needed.

### Locating the Appliance

Your new electric fireplace may be installed virtually anywhere in your home. However, when choosing a location ensure that the general instructions are followed.

- 5.1 For best results, install out of direct sunlight.
- 5.2 The appliance should be connected to an earthed electrical outlet and it must be easily accessible to allow disconnection.
- 5.3 If installing in an existing fireplace and chimney always block the chimney with fibreglass insulation or similar to prevent cold air being blown through the appliance. Failure to do this may cause poor performance and loss of heat or make the appliance cut out.

## Installation

### Installation into a fireplace opening/insert:

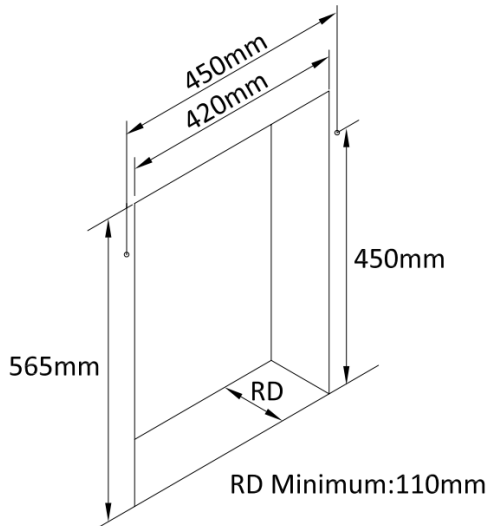

Carefully mark out the fixing screw positions as above, fit two pan head screws leaving approximately 2mm between the wall/panel and the underside of the screw head. Lift the fire into position so the keyhole slots locate on the screw heads.

## 6. OPERATING INSTRUCTIONS

**WARNING! Do not operate the appliance if it is damaged or has malfunctioned. If you suspect the appliance is damaged or has malfunctioned call a qualified service engineer to inspect the appliance, and replace any part of the electrical system if necessary, before reuse.**

**WARNING! To reduce the risk of fire, keep textiles, curtains, or any other flammable material a minimum distance of 1 meter from the air outlet.**

**MAKE SURE** the plug fits tight in the outlet. Faulty wall outlet connections or loose plugs can cause the outlet to overheat.

**Do not** disconnect the power at the mains supply whilst the appliance is running. Use the functions on the remote to turn the fire off and ensure the mains switch has been moved to the off position before disconnecting.

## PREPARATION BEFORE USE

6.1 The appliance can be operated by both remote control and the manual controls on the appliance.

**NOTE: To use both remote and manual functions the manual on/off switch must be in 'ON' position. In order to prevent the product becoming too hot, there is 10s delay when turning on the heater and a 10s delay when turning off the heater fan.**

### Batteries

Ensure that the handset batteries are new and inserted correctly.

### Main Power Switch

6.2 The mains power switch is located on the control panel located on the left-hand side of the heater box.

6.3 Switch ON (—) before operating either the remote or manual controls.

6.4 A long beep is heard to indicate the fire is ready for use.

## 6a. MANUAL CONTROL PANEL

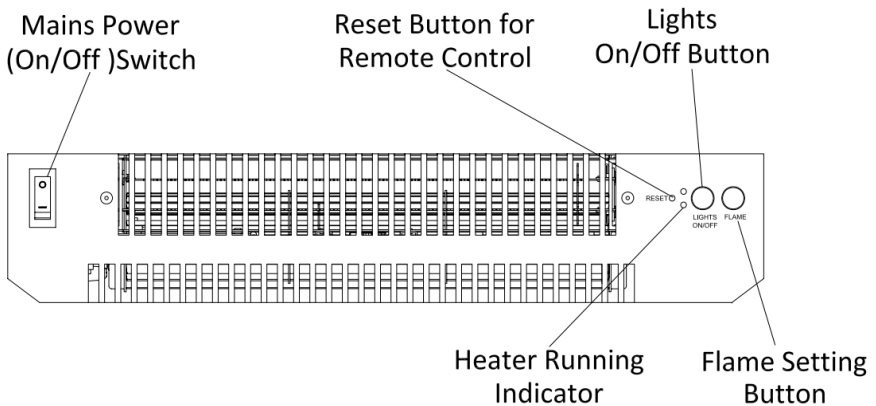

**NOTE: The manual button controls basic functions, not a full range of controls. Use the remote hand set to carry out all functions.**

6a.1 The manual buttons are located at the upper right of the appliance.

6a.2 Press "LIGHTS ON/OFF" to turn on or turn off both the flame and mood

light at the same time.

6a.3 Press "FLAME" button to select the colour of flame (3 kinds) or return to the OFF position.

**NOTE: The controls on appliance will lose the memory for all function settings when the switch is set to the Off Position.**

**When the remote runs out of power or when you change the batteries, only the flame function will lose memory and will not affect the timer settings, however, the clock may need adjusting.**

## 6b. REMOTE CONTROLS

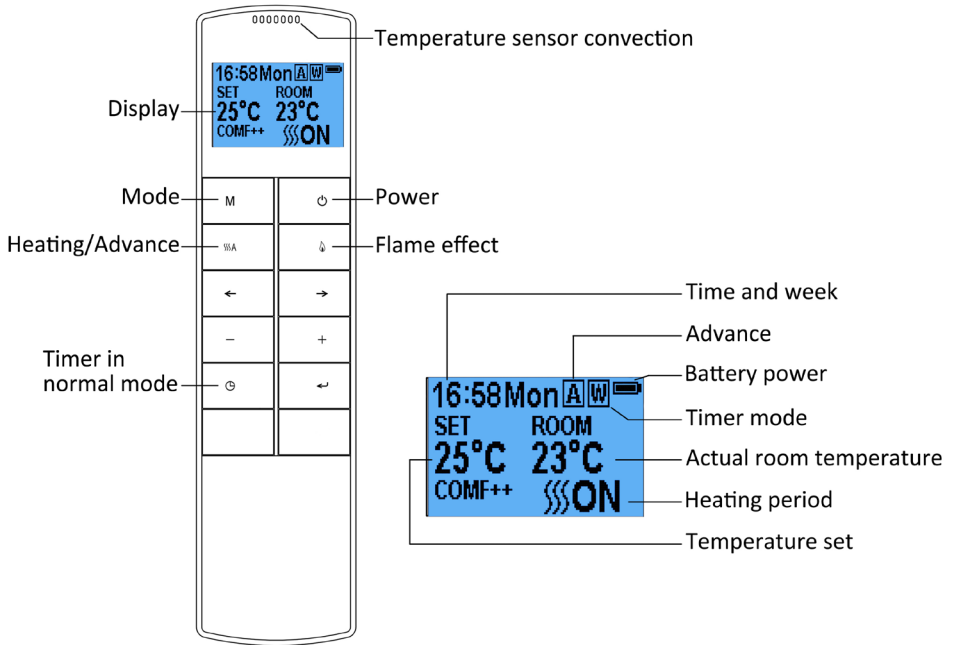

**NOTE: This is a thermostatic remote control. The remote should be in the same room as the fireplace and placed on a flat surface. It must be placed away from the fire so the hot air will not blow on it and affect the thermostatic reading.**

The communication frequency between the fire and remote has already been set up. If you cannot use the remote with the fire, please follow instructions Step 6b.29

## Standby for Remote Handset

6b.1 The screen shown to the right is when the remote handset is in standby mode.



Before Day/Time set up

## Turn on/off

6b.2 Press  to turn on the fire.



After Day/Time set up

## Flame Effect

6b.3 Press  to enter the flame effect adjustment screen.

6b.4 Press the '←' and '→' button to select the 3 Kinds of flame effect.

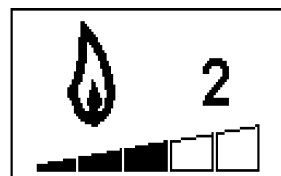



6b.5 Press the '+' and '-' button to select the 5 brightness of flame effect and OFF settings.

## Normal Mode

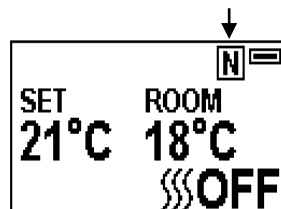
6b.6 Normal control mode is factory set. If it is not, then press **M** button until the logo  shows up at the upper right corner of the screen.



6b.7 Press  **A** button to turn on/off heat,  ON、 OFF will show at the lower of the screen.

**NOTE:** It is normal for the fan heater to stop running for periods of time. This happens because the room temperature is at or above the temperature set on the remote control. The heater indicator will be turned off after 10s if you have the flame ON. The heater indicator will stay ON if you use the heating function only.

## Count Down Timer

**NOTE:** This setting is for normal mode only. It

allows the appliance to go into standby after a set period of time.

- 6b.8 Press  to cycle through the settings from Off and 0.5 hours to 9 hours. The timer logo and time will show on the screen. **The heater must be in the ON position.**

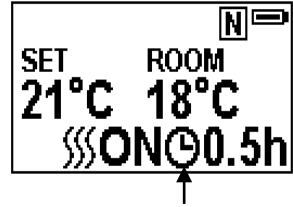

**The heater can be automatically run by using daily timer and weekly timer on the remote.**

### Set up Day, Time and Comfortable temperature

- 6b.9 Press  to turn on the remote handset. Hold the button **M** for 3 seconds to enter the setting screen.

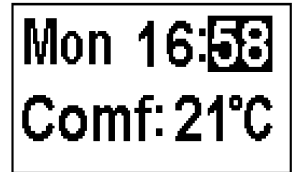

- 6b.10 Press the '←' and '→' button to choose Day, Time or your comfortable temperature. The character selected will be highlighted.

- 6b.11 Pressing the '+' and '-' button will adjust the number.

- Time: 24-hour system
- Select your comfortable temperature from 15-25°C.
- Temperature unit: °C、°F

### Daily Timer Heating

- 6b.12 The following are preset heating periods, which can be altered if desired

06:00 until 08:30  
17:00 until 22:00

- 6b.13 Press **M** until **D** shows at the upper right corner of the screen, then enter the daily timer heating mode.

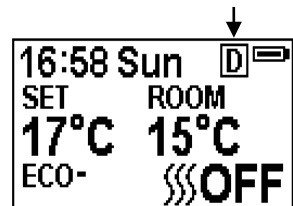

- 6b.14 Hold the arrow symbol button  for 6 seconds to enter The daily timer setting. Max 3 timed Heating periods for a day.

- Press '←' or '→' to choose hour or

minute, press '+' or '-' to set the time.

- Minute will increase/decrease by 15 minutes per press.
- Hold  for 3 seconds or wait for 10 seconds to save and exit the heating time period setting.

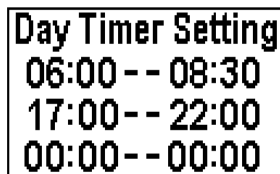

**Day Timer Setting**  
06:00 -- 08:30  
17:00 -- 22:00  
00:00 -- 00:00

#### 6b.15 Adjusting the set temperature

- Press the '+' or '-' button to increase or decrease the temperature on the basis of your comfortable temperature setting.
- ECO means 2°C lower than your comfortable temperature setting,  
ECO- means 4°C lower,  
COMF+ means 2°C higher,  
COMF++ means 4°C higher.

6b.16 To check your daily timer settings, press .

6b.17 If heating needs to be turned off, it will be necessary to go back to the Normal Mode to turn off.

### Week Timer Heating

6b.18 The following are preset heating periods, which can be altered if desired.

From Monday to Friday

06:00 until 08:30

17:00 until 22:00

From Saturday to Sunday

06:30 until 09:30



11:00 until 13:00

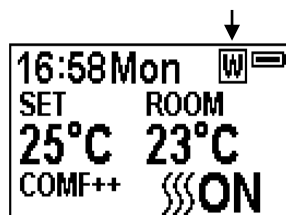

17:00 until 22:00

6b.19 Press **M** until  shows at the upper right corner of the screen, then enter the week timer heating mode.

6b.20 Hold  button for 6 seconds to enter the week timer setting.



16:58 Mon   
SET ROOM  
25°C 23°C  
COMF++  ON

- Press '←' or '→' to move the cursor (a flashing underline), press the  button in the corresponding week position to select (the character is highlighted) or cancel (the character is displayed normally) the current setting. Several days can be selected together.
- Press the '→' button to move the cursor to the time period setting area. Press '←' or '→' to choose hour or minute, press '+' or '-' to set the number.
- Max 3 heating periods for a day.
- Minute will increase/decrease by 15 minutes per press.
- Press the  to set the heating time for the selected day(s) and return to the week line.
- Hold  for 3s or wait for 10s to save and exit the heating time period setting.

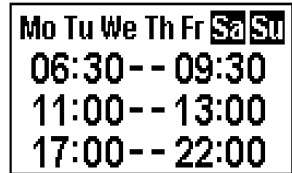
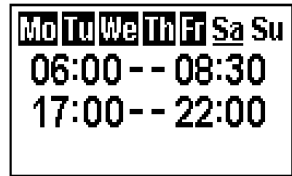

6b.21 Press , '←' and '→' to check your week Timer settings.

6b.22 If heating needs to be turned off, it will be necessary to go back to the Normal Control Mode to turn off.

### Advance Mode

6b.23 Under the daily and week timer mode, Press  **A**:

6b.24 To turn the heater off when the heater is on during a preset heating period.

6b.25 To turn the heater on when the heater is off in between preset heating periods.

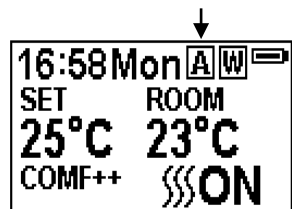

### Adaptive Start Control

6b.26 According to room temperature and set temperature, the heater will automatically come on in time to heat the room to the set temperature at the set time. For example, if your timer is set to start at 18:00 and temperature is set to 23°C, the fire will come

on at 17:30 to ensure the room is 23°C at 18:00.

### Window Open Detection

6b.27 When the remote control detects a rapid drop in room temperature, it will be identified as a window open, the warning icon will be displayed and the heating will be turned off automatically.



6b.28 After the indoor temperature has risen or a manual override of the warning (by operating remote control) has been done, the fire will return to normal working state.

### Set up the communication between the remote and appliance

6b.29 The steps below should be followed before programming, when changing to a new remote and the remote control is not correctly set up:

- Hold the reset button on the appliance for 3 seconds (pen Point may needed) until you hear 3 short beeps from the unit, release the button.
- Press the  button on the remote, the programming is finished when you hear 1 long beep from the appliance.

6b.30 Resetting the code for remote control is necessary if the appliance or the remote control do not operate correctly.

- Open the back cover of the remote control.
- Press the Reset button on remote handset.
- Follow the steps 6b.29



### Resetting the Thermal Cut Out

6b.31 The appliance is fitted with an Electronic Safety Control (E.S.). This is a safety device, which switches off the fire if, for any reason, the appliance overheats, e.g. when covered. If the heater stops operating while the

flame effect continues working normally, this indicates that the E.S. Control is in operation. The E.S. Control can only be re-set after the appliance has cooled down, and the appliance has been reset. Re-setting of the E.S. Control proceeds is as follows:

- 6b.32 Switch off the appliance (Manual On/Off switch) and leave it off for approximately 10-15 minutes.
- 6b.33 Remove any obstruction to the fan heater outlet or fan blades etc. Make sure that the power supply is disconnected with the plug socket outlet while doing this.
- 6b.34 Switch on the appliance and the E.S. Control will be re-set.
- 6b.35 Ensure that the appliance is functioning correctly. If the E.S. Control operates again, the appliance should be checked by a competent electrician.

## 7. MAINTENANCE

**WARNING: Before any maintenance or cleaning of the exterior of the fireplace, the unit should be disconnected from the power supply until it is cool off.**

### Remote Handset Battery Replacement

To replace the battery:

- A. Slide battery cover open on the remote control.
- B. Correctly install 2 x AAA 1.5V standard batteries in the battery holder.
- C. Close the battery cover.

7.1 When the batteries are at full power, the battery symbol will show 

7.2 When the batteries are half full, the battery symbol will show 

7.3 When the batteries are out of power and need replacing immediately, the battery symbol will show 

7.4 Battery replacement is recommended after 1 year. Please replace all batteries of a set at the same time.

7.5 Dispose of old batteries at an appropriate recycling facility.

7.6 The batteries are 1.5V alkaline AAA batteries. Always purchase the right size

and grade of battery most suitable for the intended use.

- 7.7 Clean the battery contacts and also those of the device prior to battery installation.
- 7.8 Ensure the batteries are installed correctly with regard to polarity (+ and -).
- 7.9 Remove batteries from equipment which is not to be used for an extended period of time.
- 7.10 Remove used batteries promptly.
- 7.11 Do not mix old and new batteries.
- 7.12 Do not mix alkaline, standard(carbon zinc), or rechargeable(nicd, nimh,etc.) batteries.
- 7.13 The supply terminals are not to be short-circuited.

### **Cleaning the Fireplace**

Cleaning or polishing products are not recommended. Fingerprints or other marks on the front glass panel can be removed by a piece of soft, damp, lint-free cloth with a good quality household glass cleaner. The front glass panel should always be completely dried with a clean, lint-free cloth or paper towel.

**CAUTION:** Abrasive cleaners should not be used on the glass panel. Liquids should not be sprayed directly onto any surface of the unit.

## 8. Others

### Environment



Meaning of crossed –out wheeled dustbin:

Electrical appliances should not be disposed as unsorted municipal waste. Separate collection facilities should be used in the disposal of electrical appliances. To have this appliance processed at the end of its useful life please contact WEEECare Plc on 0844 8002004. The relevant producer number is WEE/MM3069AA.



This fire complies with the Safety Standards EN 60335-1 and EN 60335-2-30 which covers the essential requirements of the Low Voltage Directive 2014/35/EU and the EMC standards EN 55014-1; EN 55014-2; EN 61000-3-2 and EN 61000-3-3 which covers the essential requirements of the European Electro Magnetic Compatibility 2014/30/EU, and the RED standards EN300220-2, EN301489-1, EN301489-3 and EN62479 which covers the essential requirements of the European Radio Equipment Directive 2014/53/EU.

Control PCB	Remote Control Receiver	Remote Control Transmitter
Hardware: RC01-040A04 Software: 20171024	Hardware: RF290B V1.2	Frequency: ASK/OOK 433.92MHZ Maximum transmit power: 10mW Hardware:RF290A-TX-V1.3 Software: RF290A_C_V0.6.0.hex