

# Bar Cabinet

# WF320348AAB

Assembly Instructions - Please keep for future reference

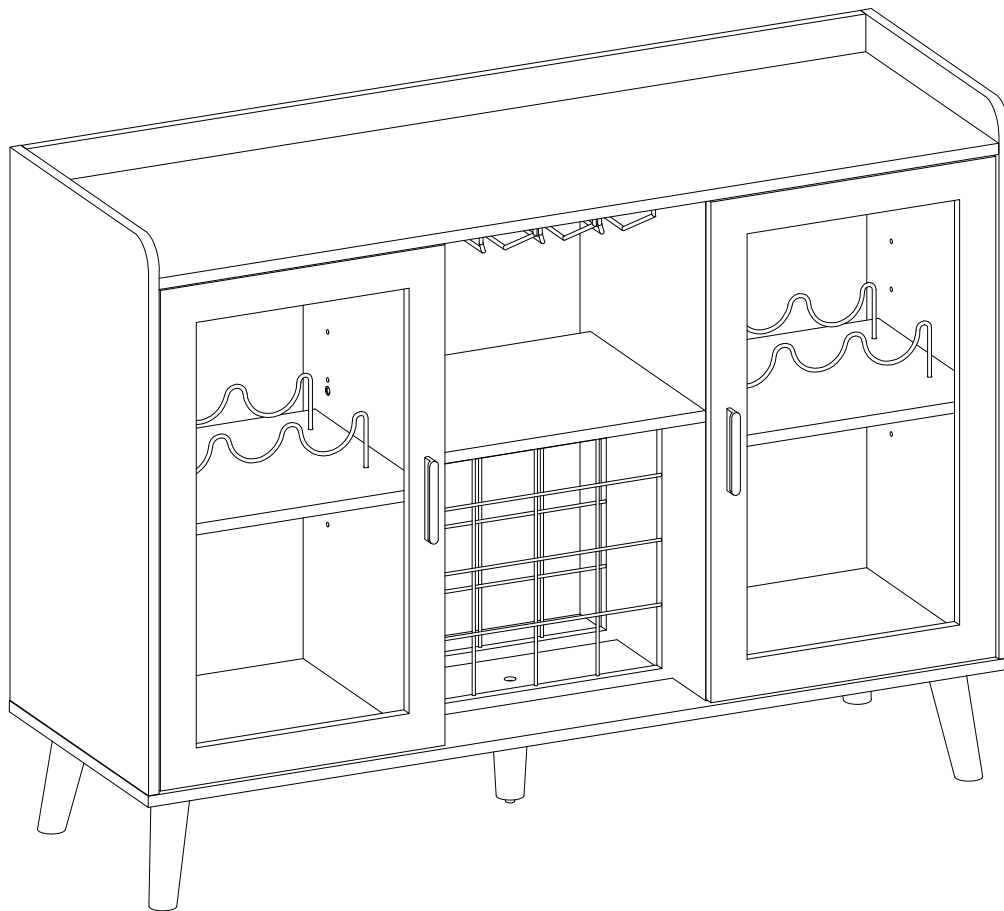

Important – Please read these instructions fully before starting assembly

# Safety and Care Advice

**Important – Please read these instructions fully before starting assembly**

- Check you have all the components and tools listed on the following pages.
- Remove all fittings from the plastic bags and separate them
- Keep children and pets away from the installation area, which may cause choking if small parts are swallowed.
- Make sure you have enough space to layout the parts before

- Do not stand or apply weight to the product during assembly. This may cause damage.
- Assemble the item as close to its final position (in the same room) as possible.
- Assemble on a soft level surface to avoid damage to the unit or floor.
- It's easier for two people to assemble the parts together.

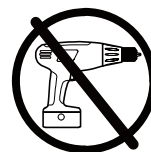

- To reduce the likelihood of damage to your product, make sure your power drill is set to a low torque setting.

## Care and maintenance

- Only clean using a damp cloth and mild detergent, do not use bleach or abrasive cleaners.
- Check for loose screws on this unit from time to time.
- This product should not be discarded with household waste. Take to your local authority waste disposal centre.

## Handy Hints

- Assemble all parts and bolts loosely during assembly, only once the product is complete should you fully tighten the bolts
- Regularly check and ensure that all bolts and fittings are correctly tightened.

## **WARNING** In order to help prevent overturning – please follow these instructions

To help prevent product toppling over please follow the below steps:-

Use the anti tip strap or wall fixing method provided (if applicable)  
Do not allow children to climb or hang on the furniture  
Do not open more than one drawer at a time  
Do not place heavy items in the top drawers  
Do not place heavy items on top of the furniture, unless the furniture has been designed for this purpose

please note that only the anti tip strap is provided.

You will need to provide wall plugs and screws applicable for your wall type

# Using Camlocks

## Step 1

Connect the male camlock as directed in the assembly instructions using a screwdriver.

1 DO NOT OVER TIGHTEN.

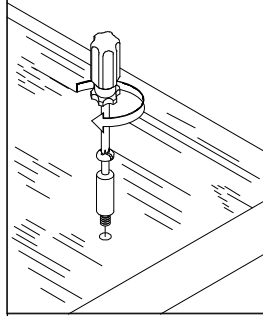

## Step 2

Push the male camlock into the entry hole.

2

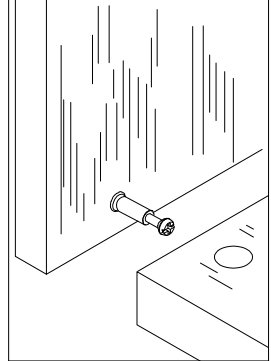

## Step 3

Insert the female camlock as shown in the instruction.

Note: ensure that the arrow on the top of the camlock points towards the entry hole for the male camlock.

3

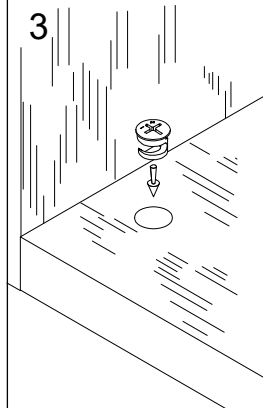

## Step 4

Turn the female camlock clockwise with a screwdriver.

You should feel a click when the camlock is locked in place.

The joint is now secure.

4

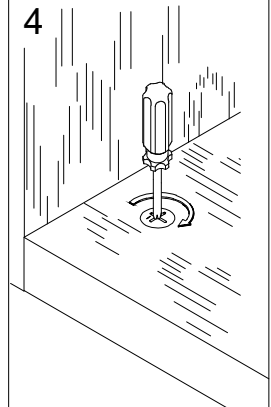

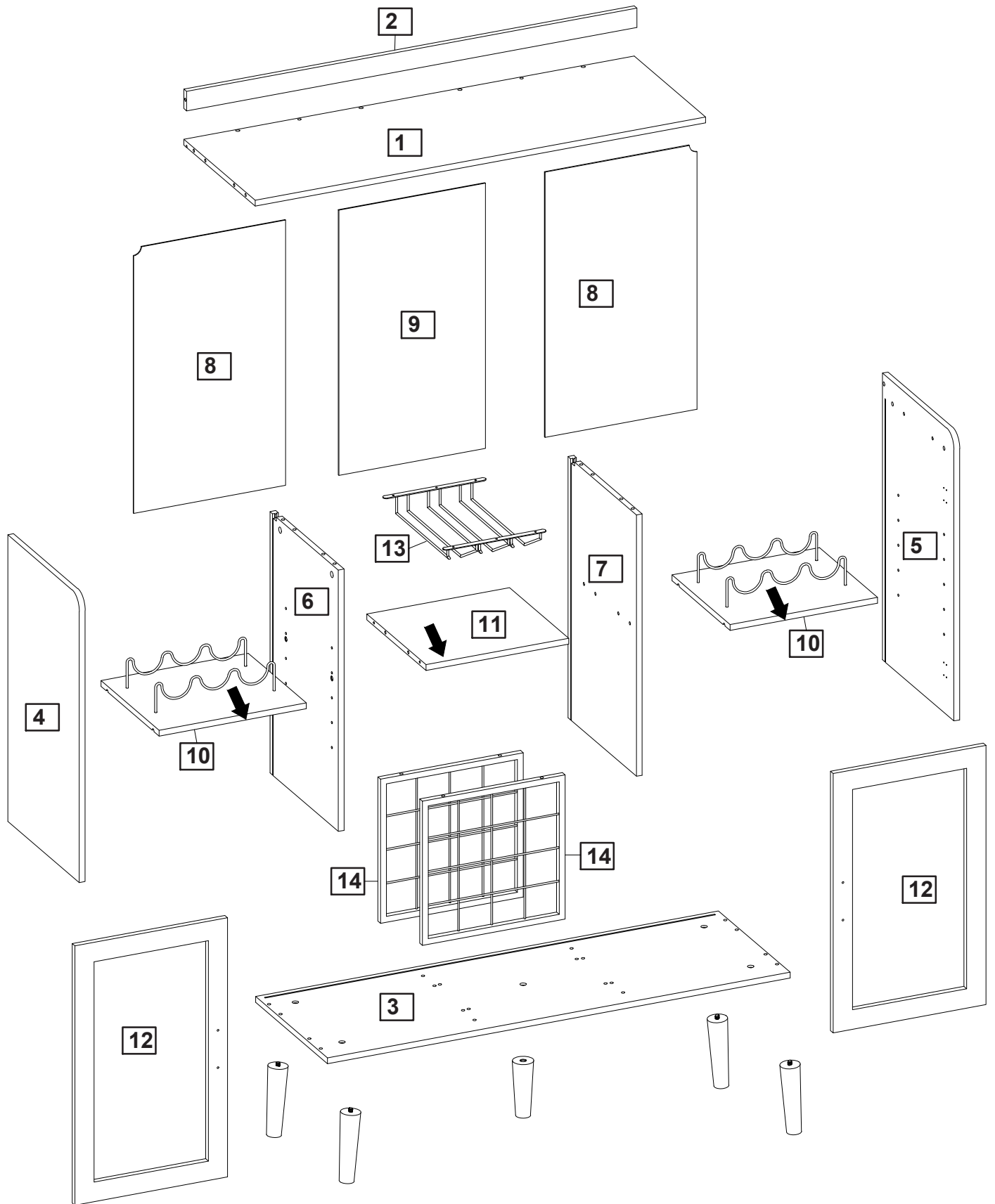

# Assembly Instructions



# Part List: WF320348AAB

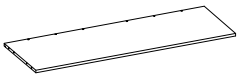
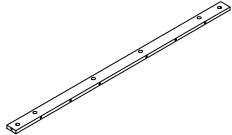
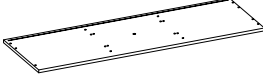
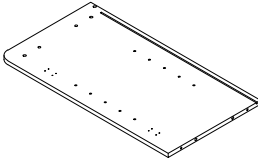
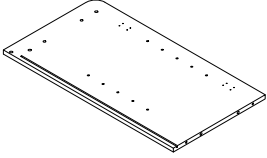
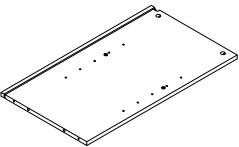
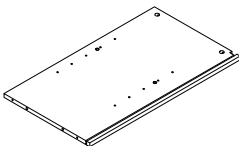

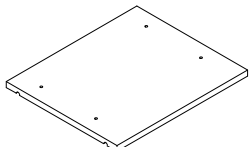
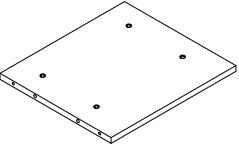
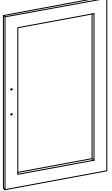
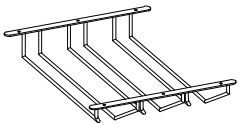
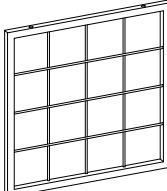
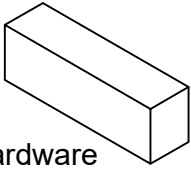















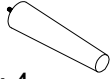

Please check you have all the panels listed below

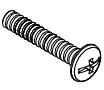
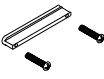
|  |   |  |   |   |
|--|---|--|---|---|
|  <p>1 PC</p>  |  <p>1 PC</p>   |  <p>1 PC</p>  |  <p>1 PC</p>    |  <p>1 PC</p>               |
|  <p>1 PC</p>  |  <p>1 PC</p>   |  <p>2 PCS</p> |  <p>1 PC</p>   |  <p>2 PCS</p>              |
|  <p>1 PC</p> |  <p>2 PCS</p> |  <p>1 PC</p> |  <p>2 PCS</p> |  <p>Hardware<br/>1 PC</p> |

# Hardware list: WF320348AAB

Please check you have all the panels listed below

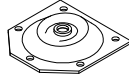
**Note:** The quantities below are the correct amount to complete the assembly. In some cases more fittings may be supplied than are required.

|  |   |   |
|--|---|---|
| <b>A</b> <br>Male Camlock x 14      | <b>B</b> <br>Female Camlock x 14   | <b>C</b> <br>Dowel x 22            |
| <b>D</b> <br>Shelf Support Pin x 8  | <b>E</b> <br>3.5*14mm Screw x 30   | <b>F</b> <br>6.8*48mm Screw x 12   |
| <b>G</b> <br>3*17mm Screw x 12      | <b>H</b> <br>Plasticwedge x 12     | <b>I</b> <br>6*25mm Screw x 8      |
| <b>J</b> <br>Protective Feet x 4    | <b>K</b> <br>Door Hinge x 4        | <b>L</b> <br>Legs x 4              |
| <b>M</b> <br>Middle Leg x 1        | <b>N</b> <br>8*30mm Screw x 1     | <b>O</b> <br>Handle & Fixings x 2 |
| <b>P</b> <br>Wine Rack x 4        | <b>Q</b> <br>Light Strip x 1     | <b>R</b> <br>Ø20 Sticker x 24    |
| <b>S</b> <br>Wall Fixing Pack x 2 | <b>T</b> <br>Adjustable foot x 1 | <b>U</b> <br>Wire Holder x 4     |
| <b>V</b> <br>Metal Plate x 4      | <b>W</b> <br>4*16mm Screw X 20   | <br>x 1                          |

## Tools required



Phillips screwdriver  
(medium & large), This is not include in the hardware.

## Ruler - Use this ruler to help correctly identify the screws

0 5 10 15 20 25 30 35 40 45 50 55 60 65 70 75 80 85 90 95 100 105 110 115 120 125 130 135 140 145 150 155 160 165 170

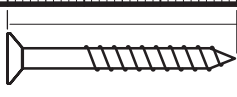

The screws length is measured from the head to the point (30mm screw shown).

# Assembly Instructions

## Step 1

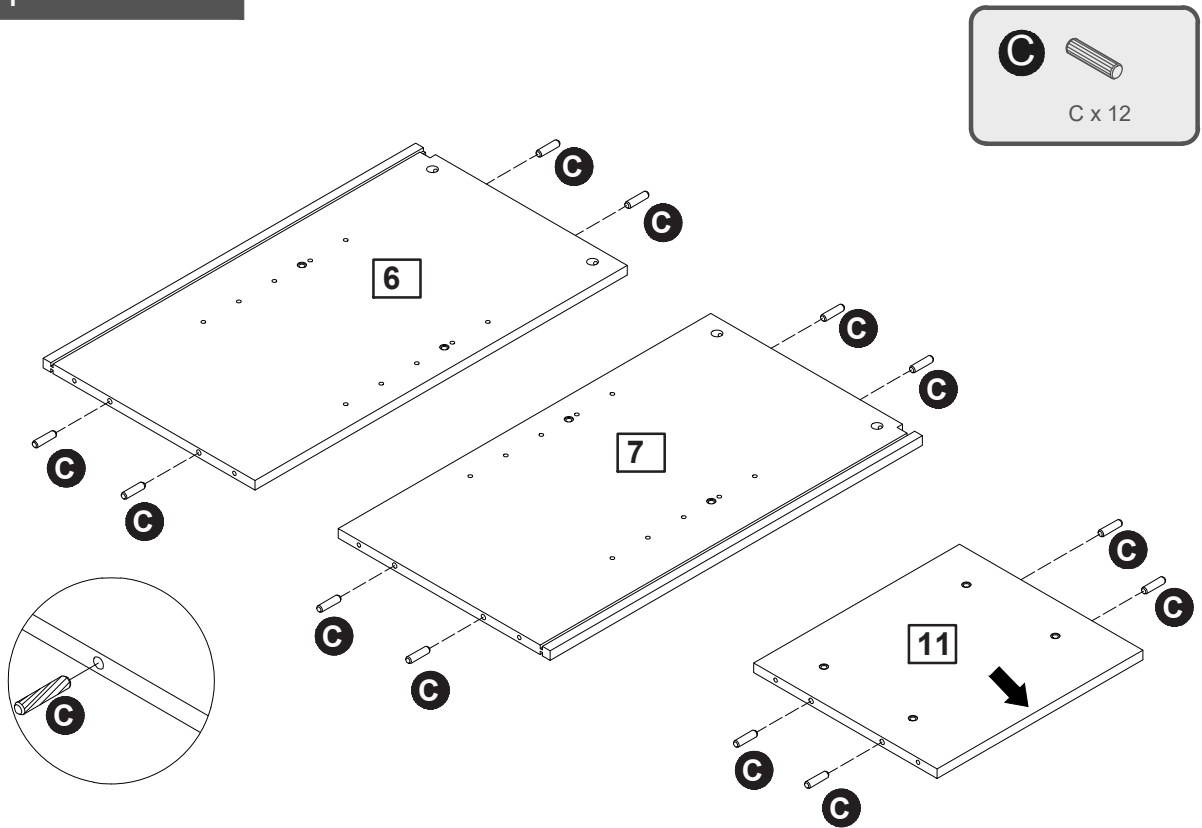

## Step 2

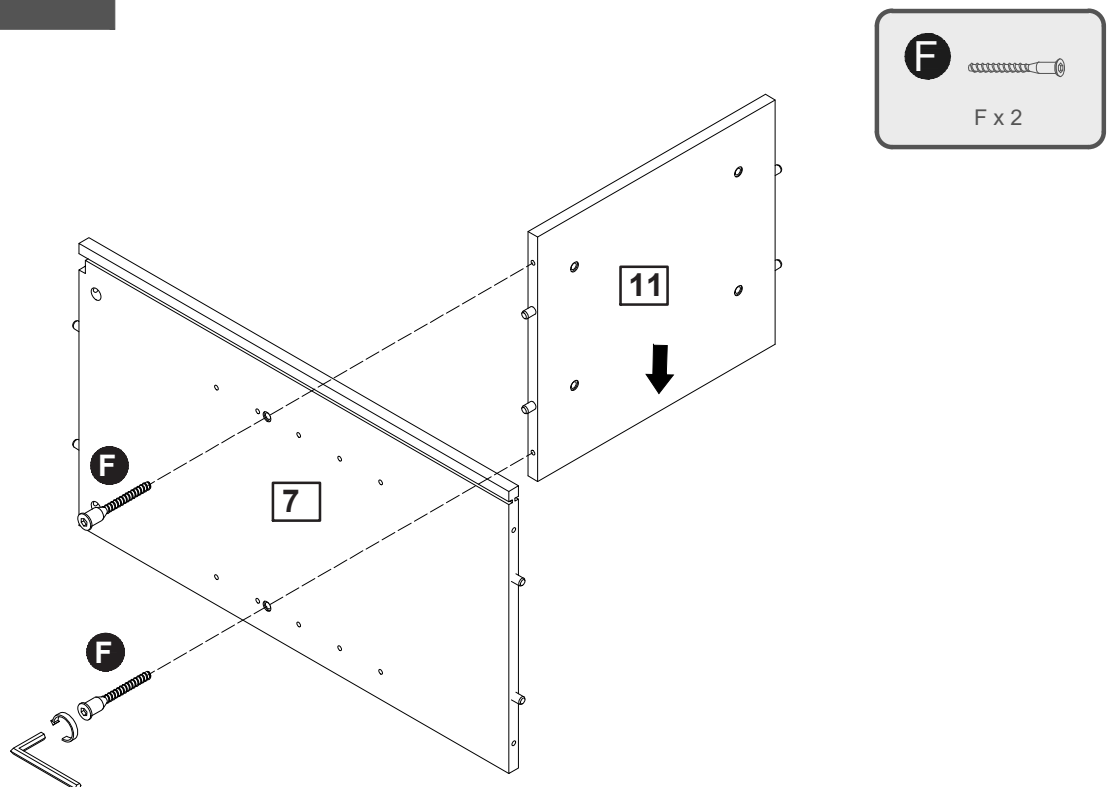

# Assembly Instructions

## Step 3

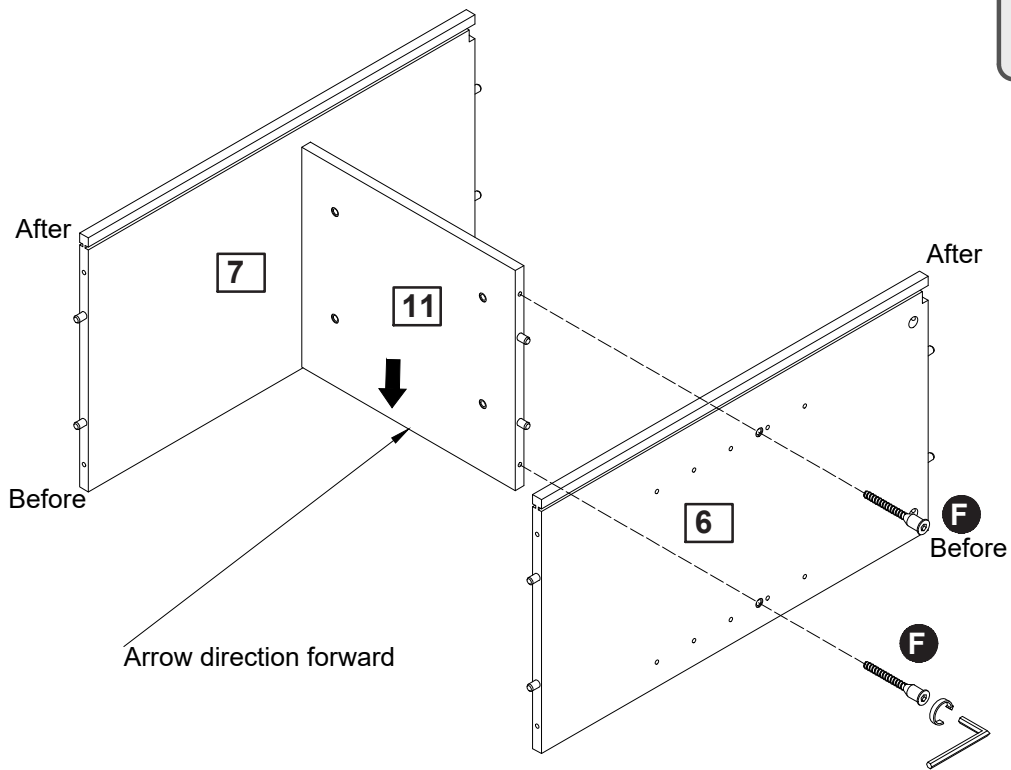

## Step 4

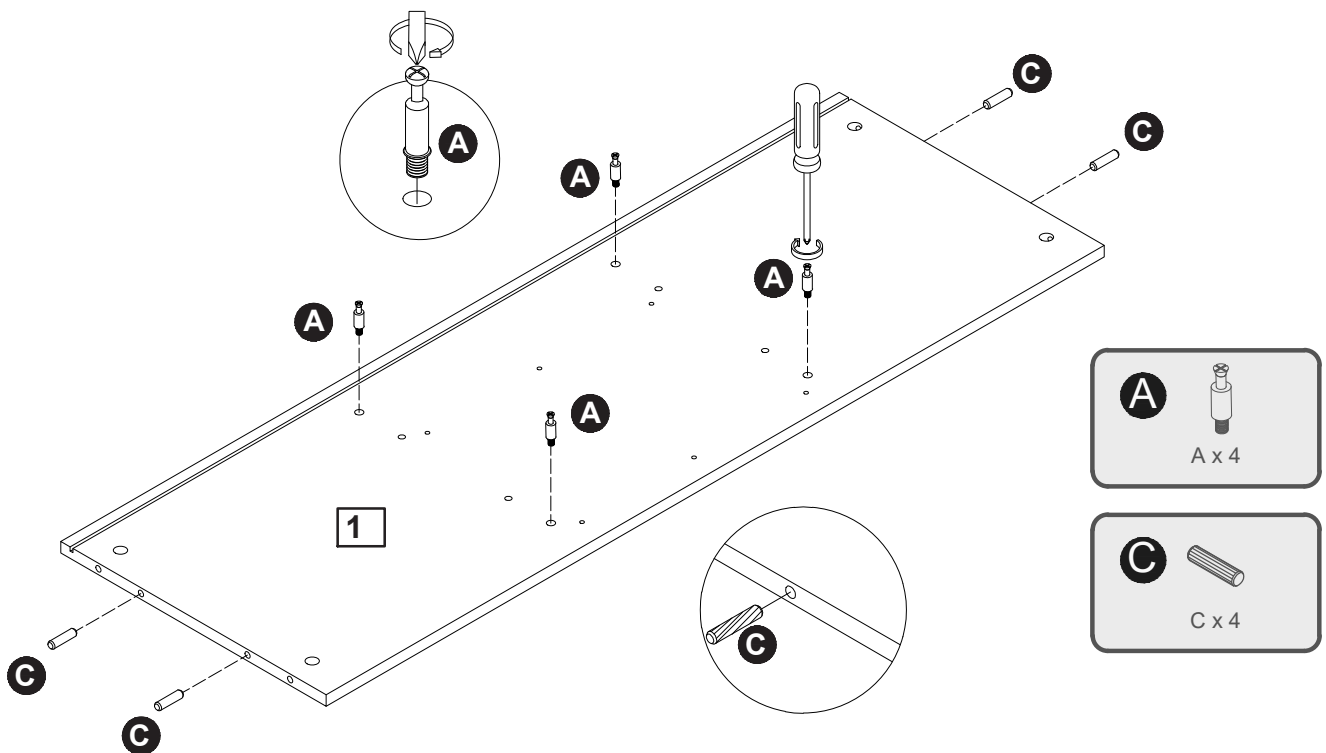



# Assembly Instructions

## Step 7

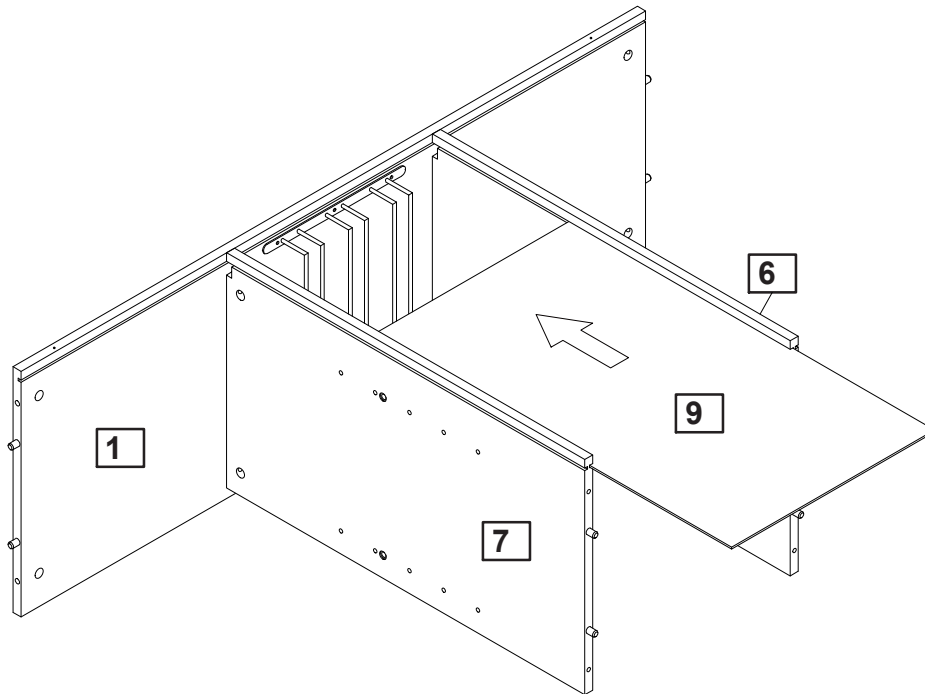

## Step 8

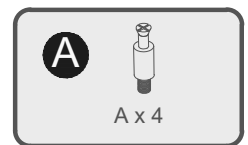
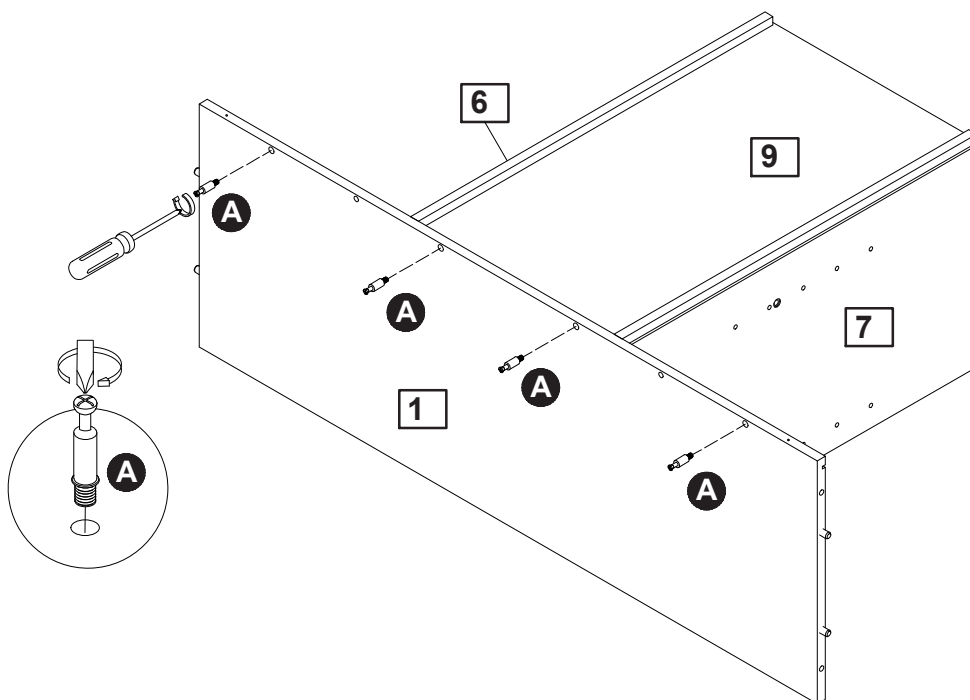

# Assembly Instructions

## Step 9

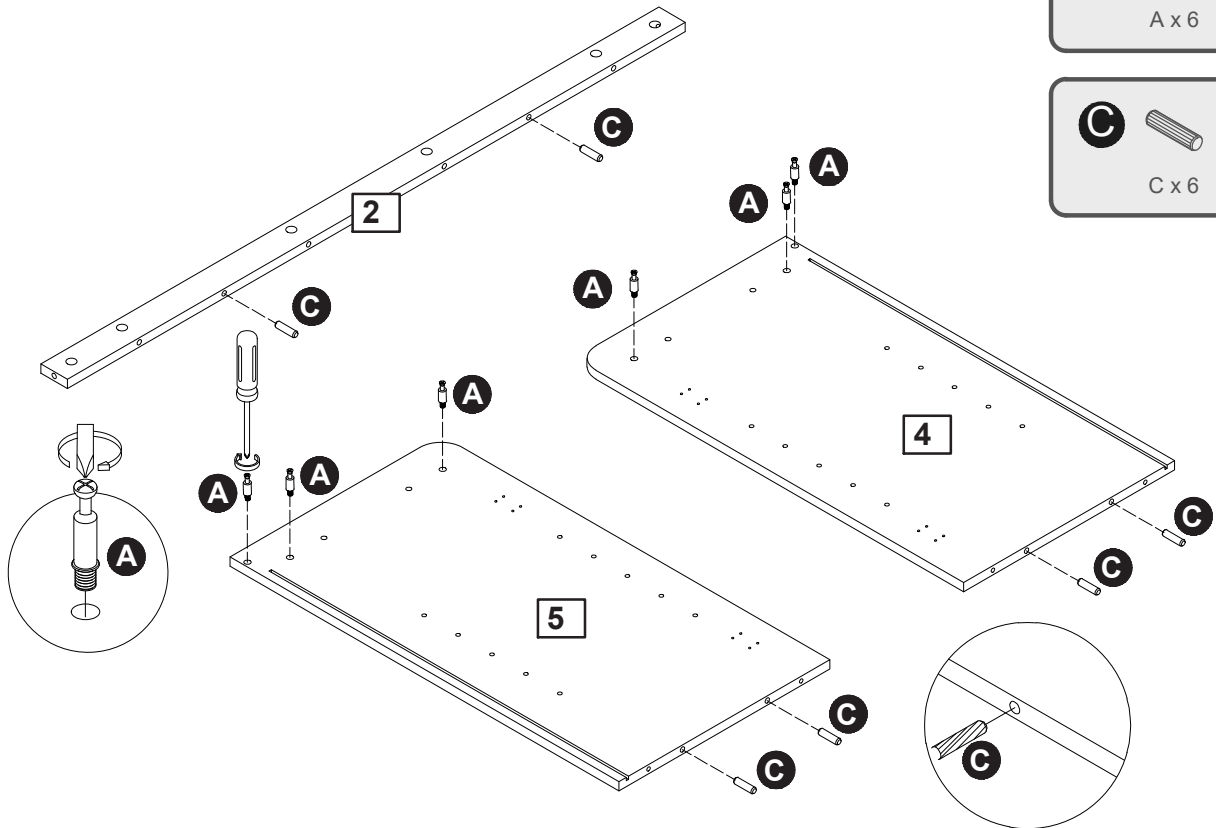

## Step 10

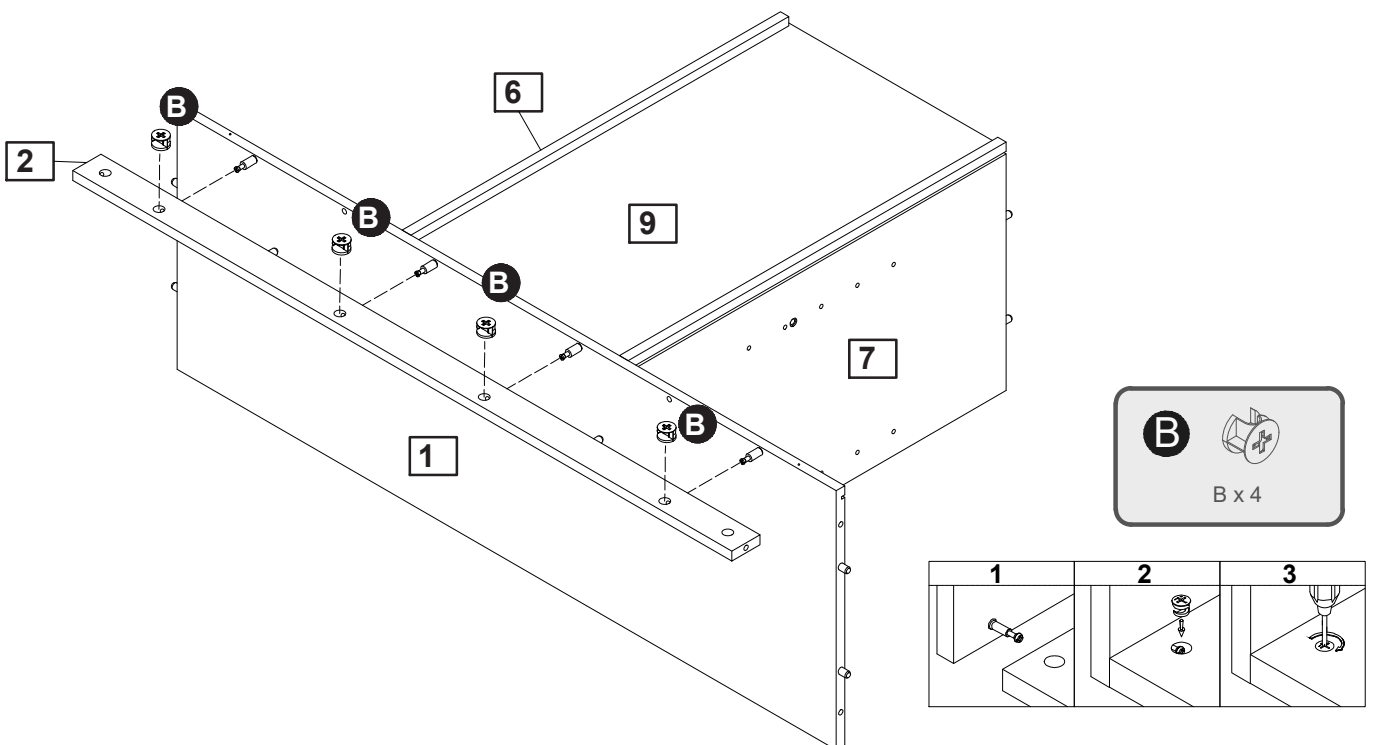

# Assembly Instructions

## Step 11

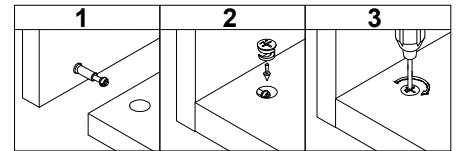
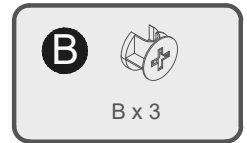
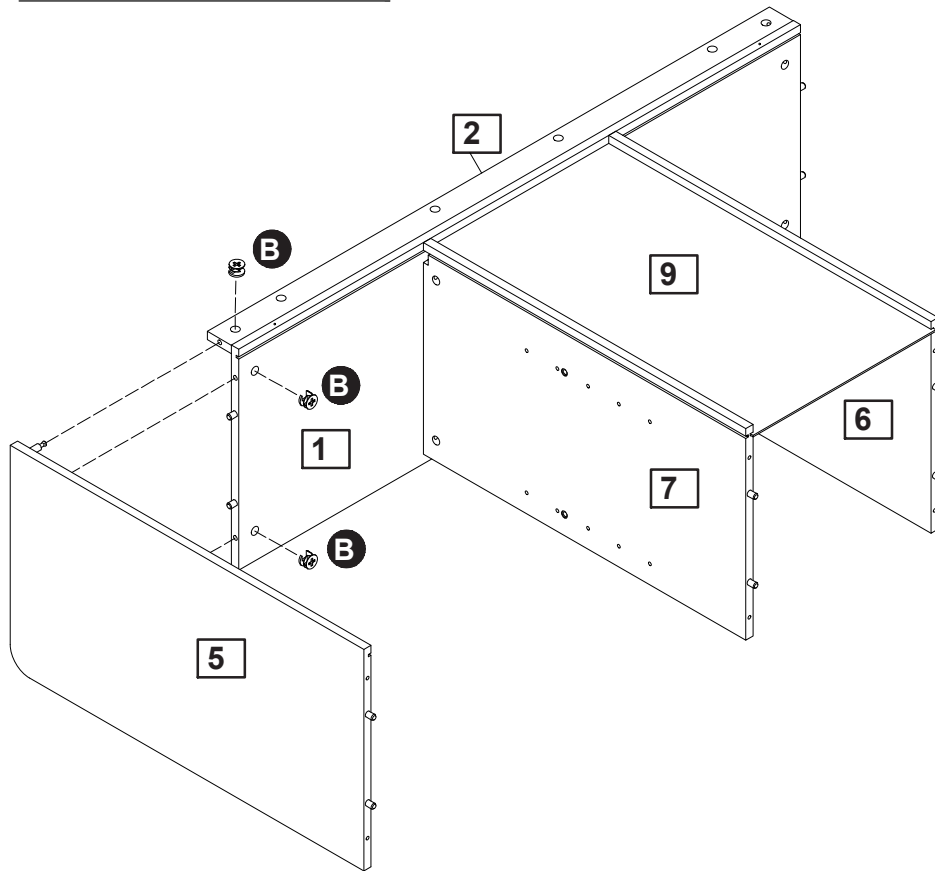

## Step 12

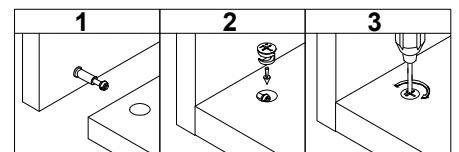
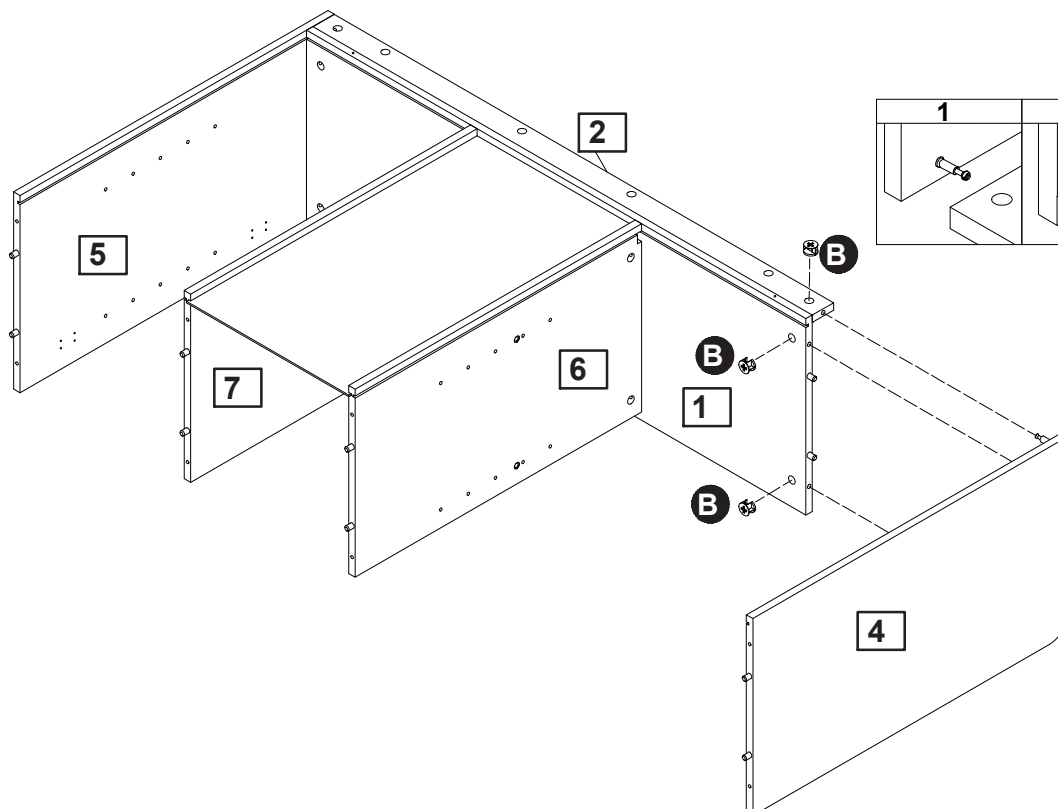

# Assembly Instructions

## Step 13

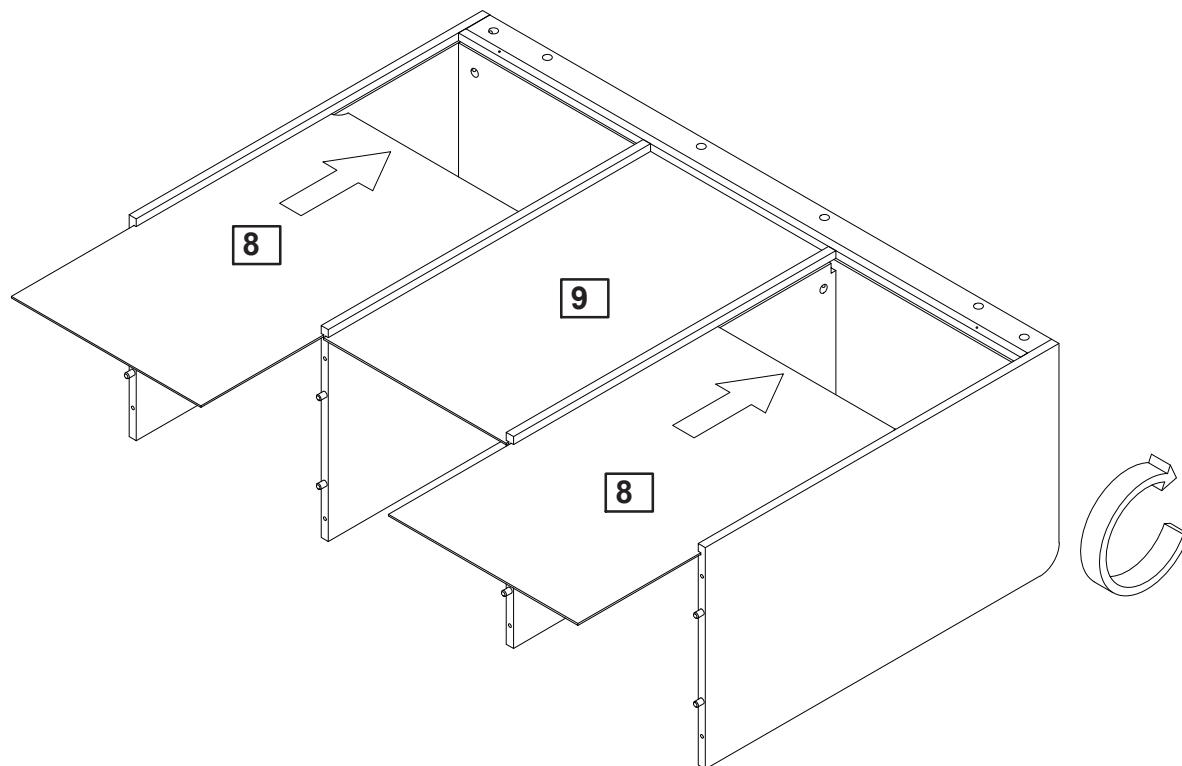

## Step 14

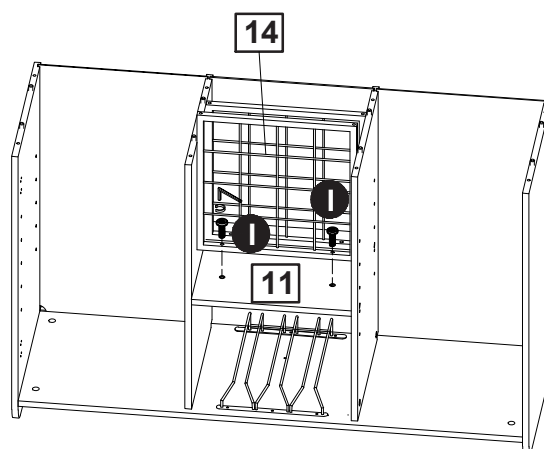
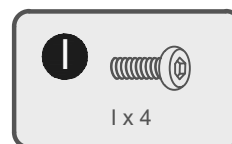
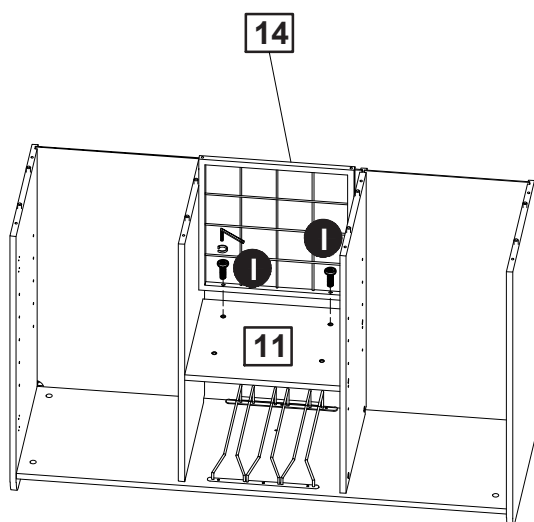

# Assembly Instructions

## Step 15

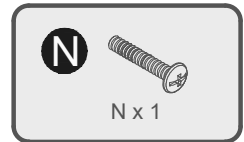
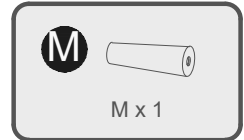
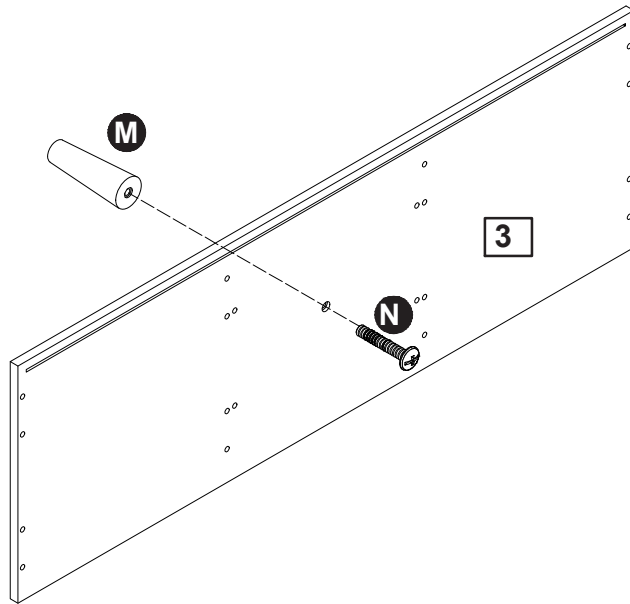

## Step 16

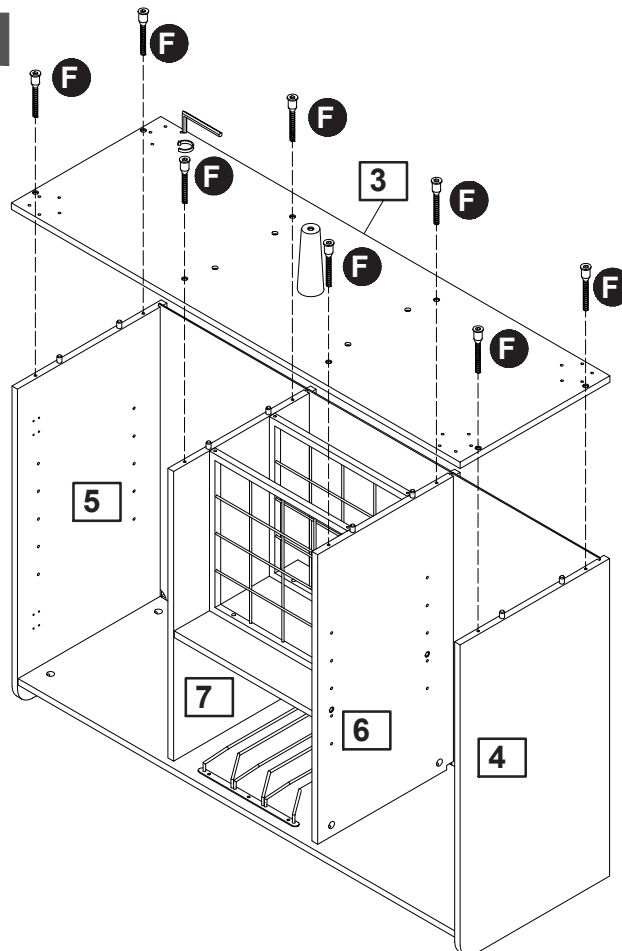

# Assembly Instructions

## Step 17

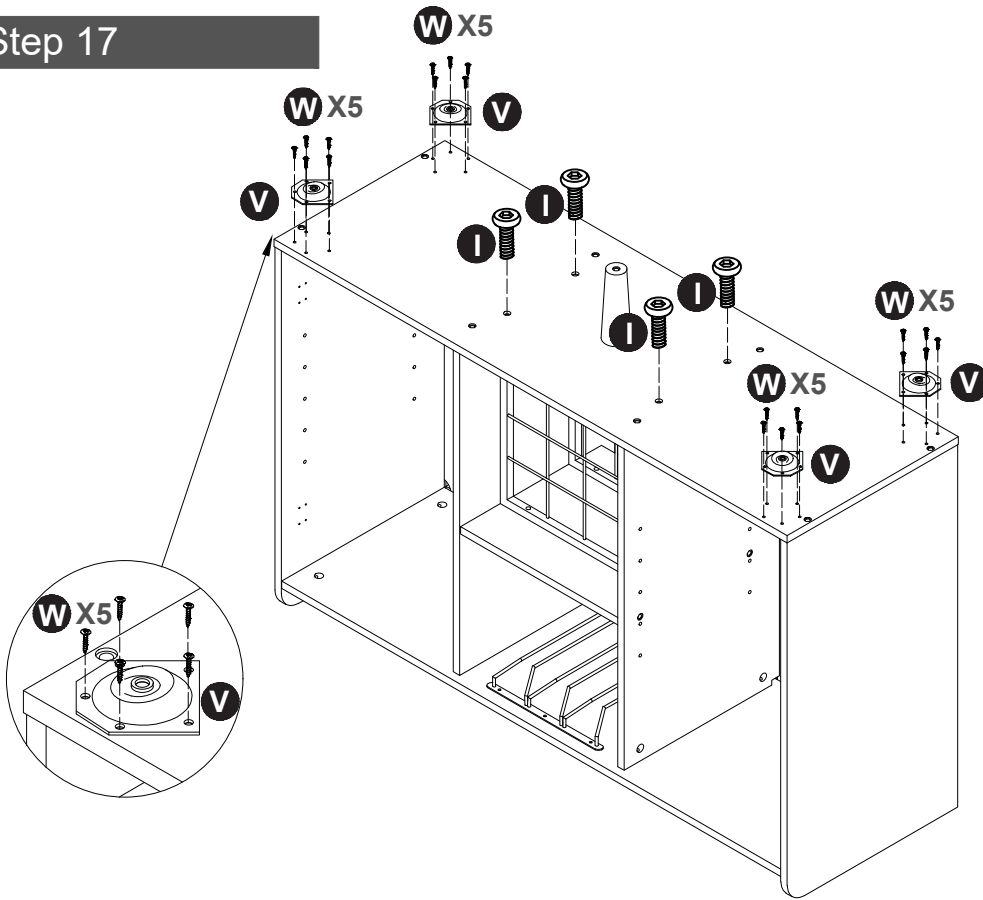

## Step 18

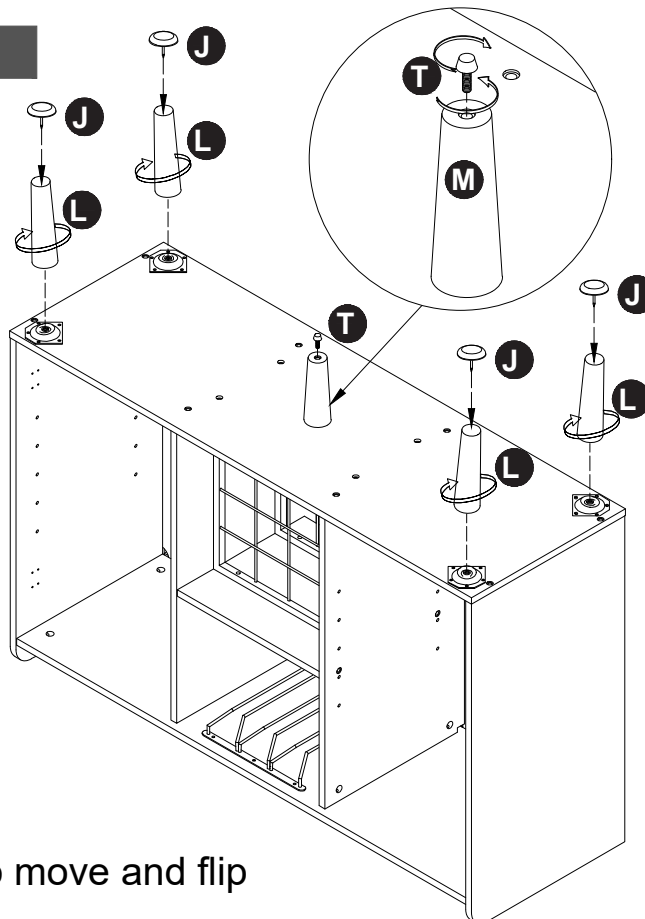

Need two people to move and flip



# Assembly Instructions

## Step 19

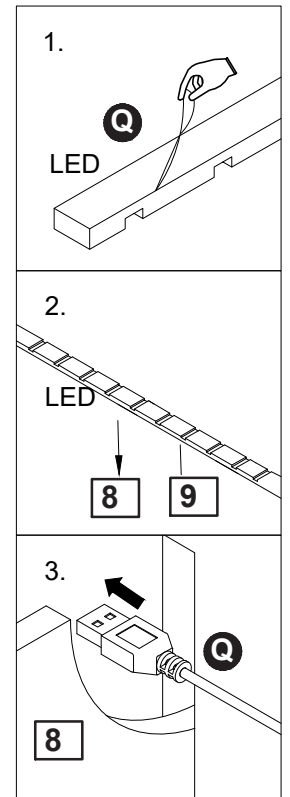
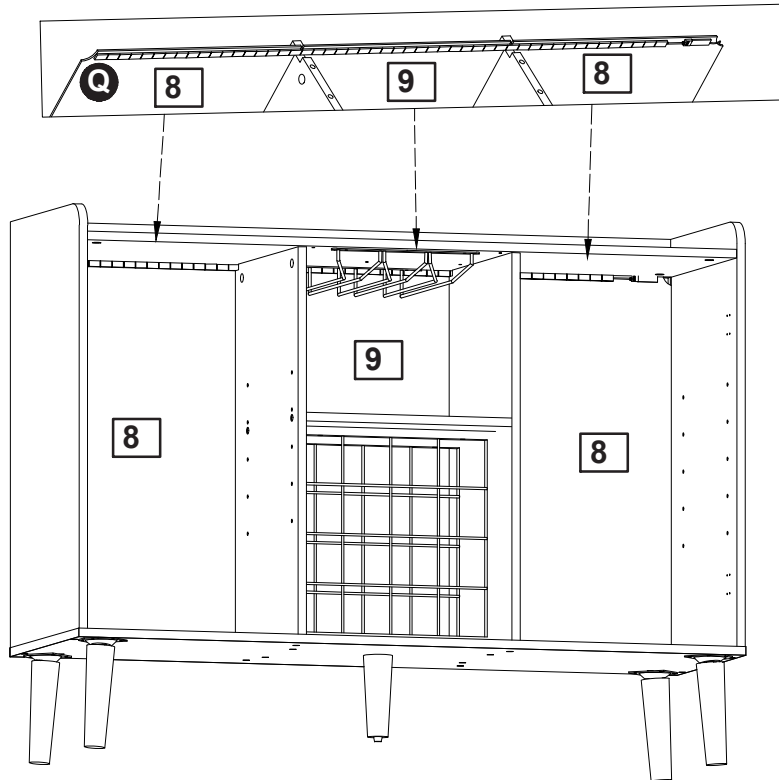
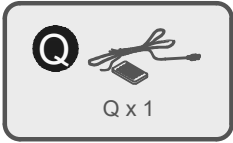

## Step 20

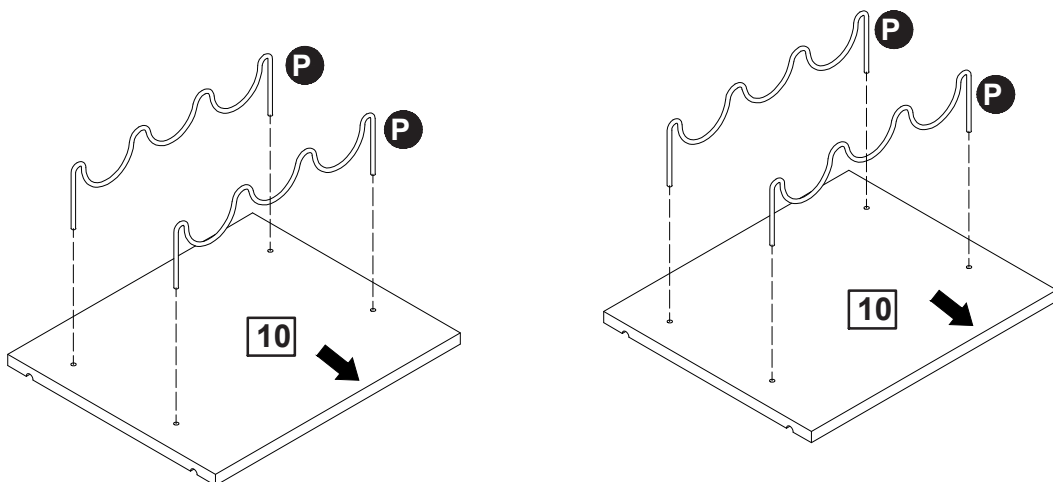

# Assembly Instructions

## Step 21

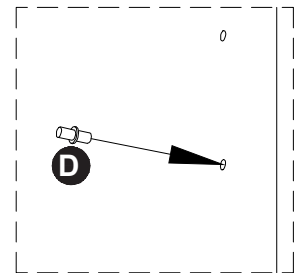
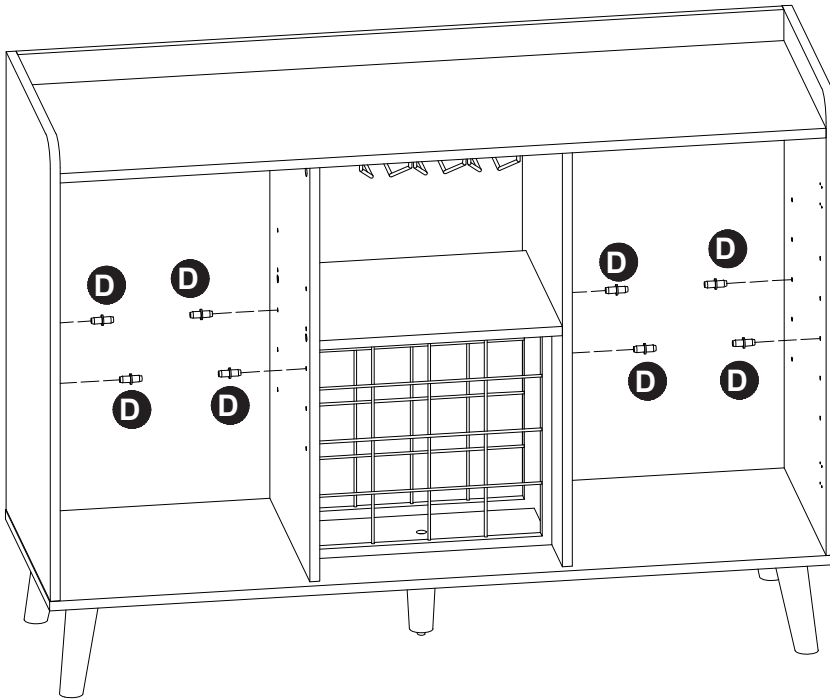
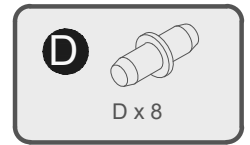

## Step 22

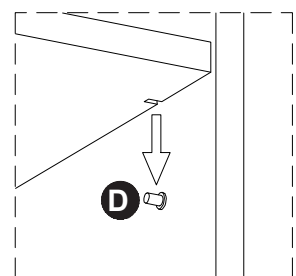
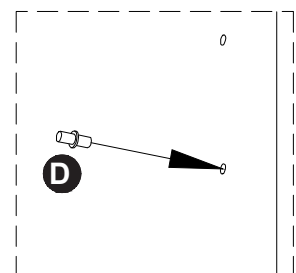
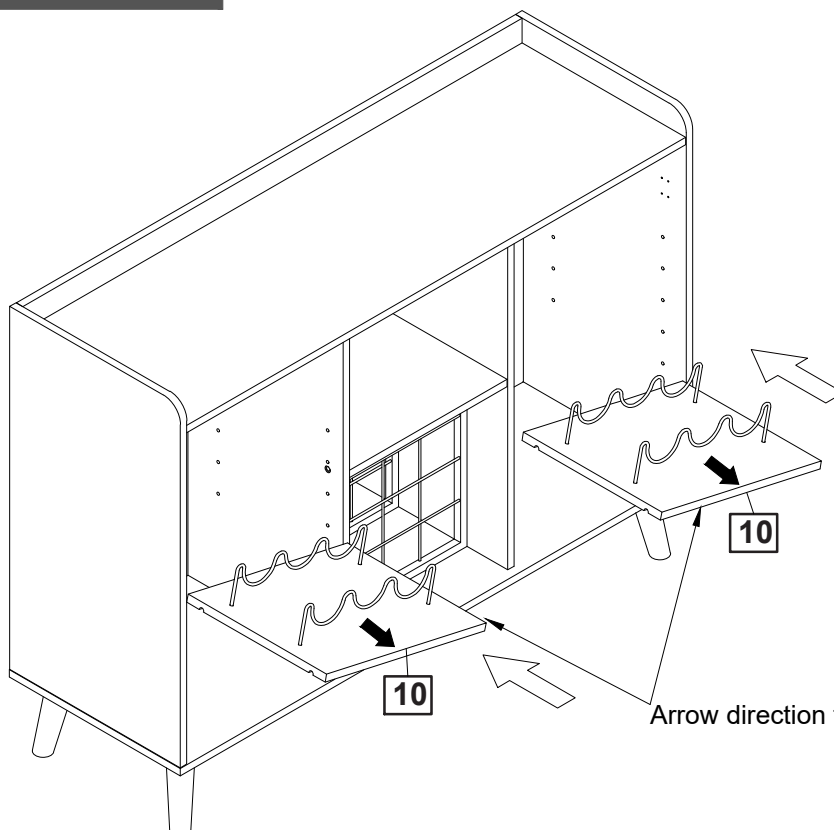

Arrow direction forward

# Assembly Instructions

## Step 23

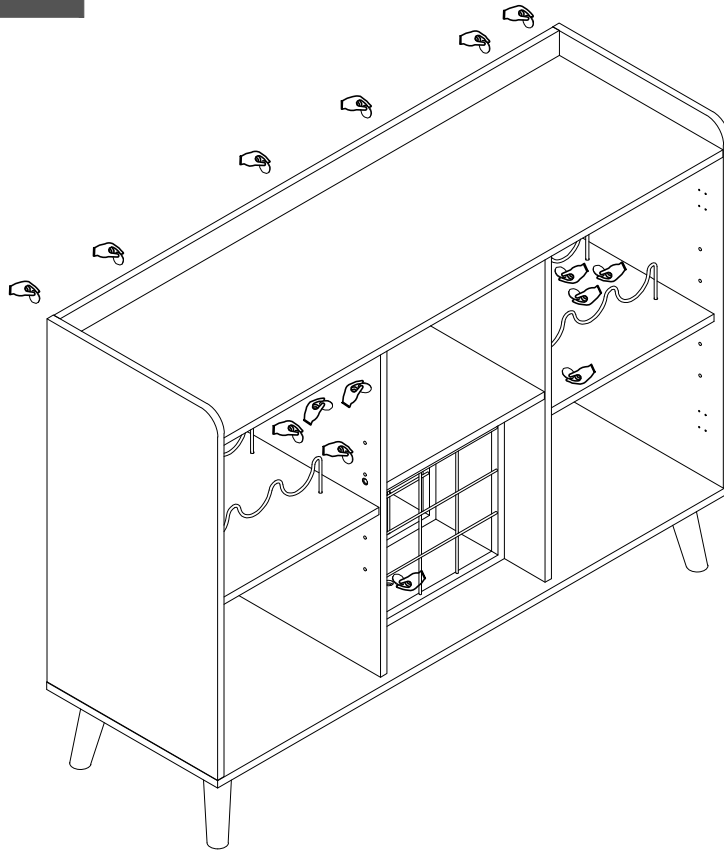
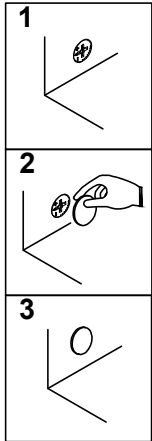

**R** x24

## Step 24

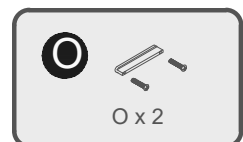
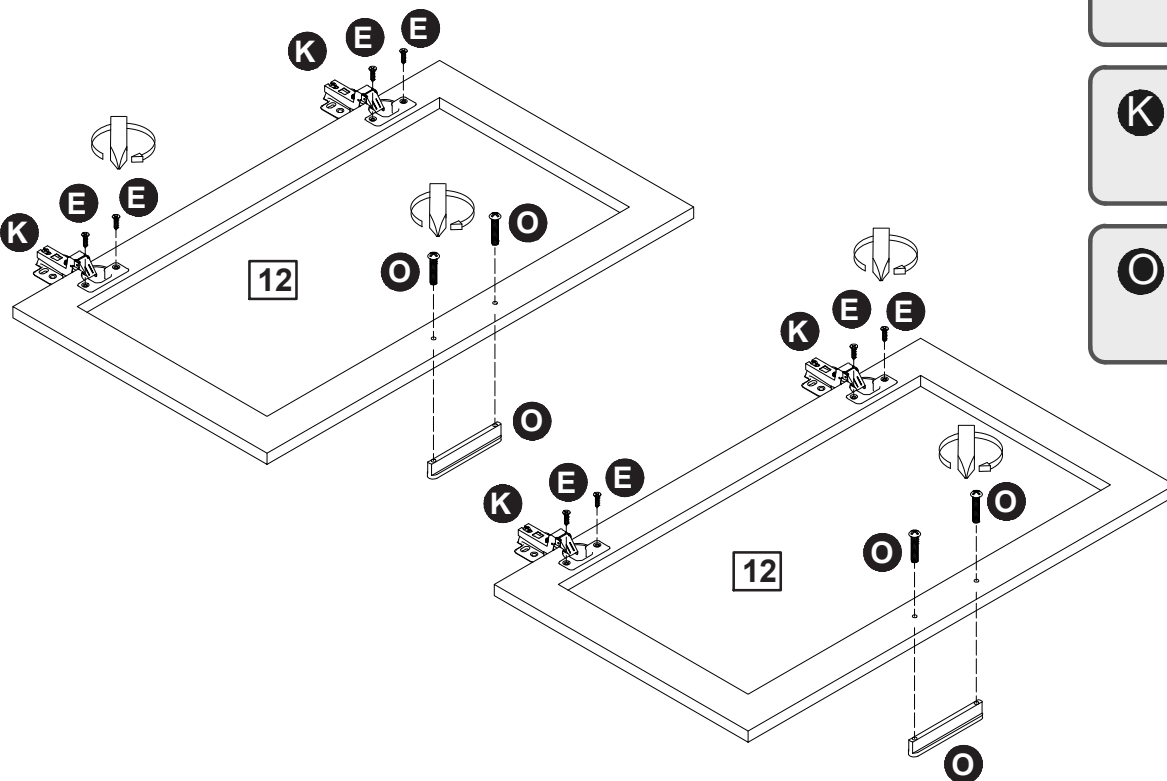

# Assembly Instructions

## Step 25

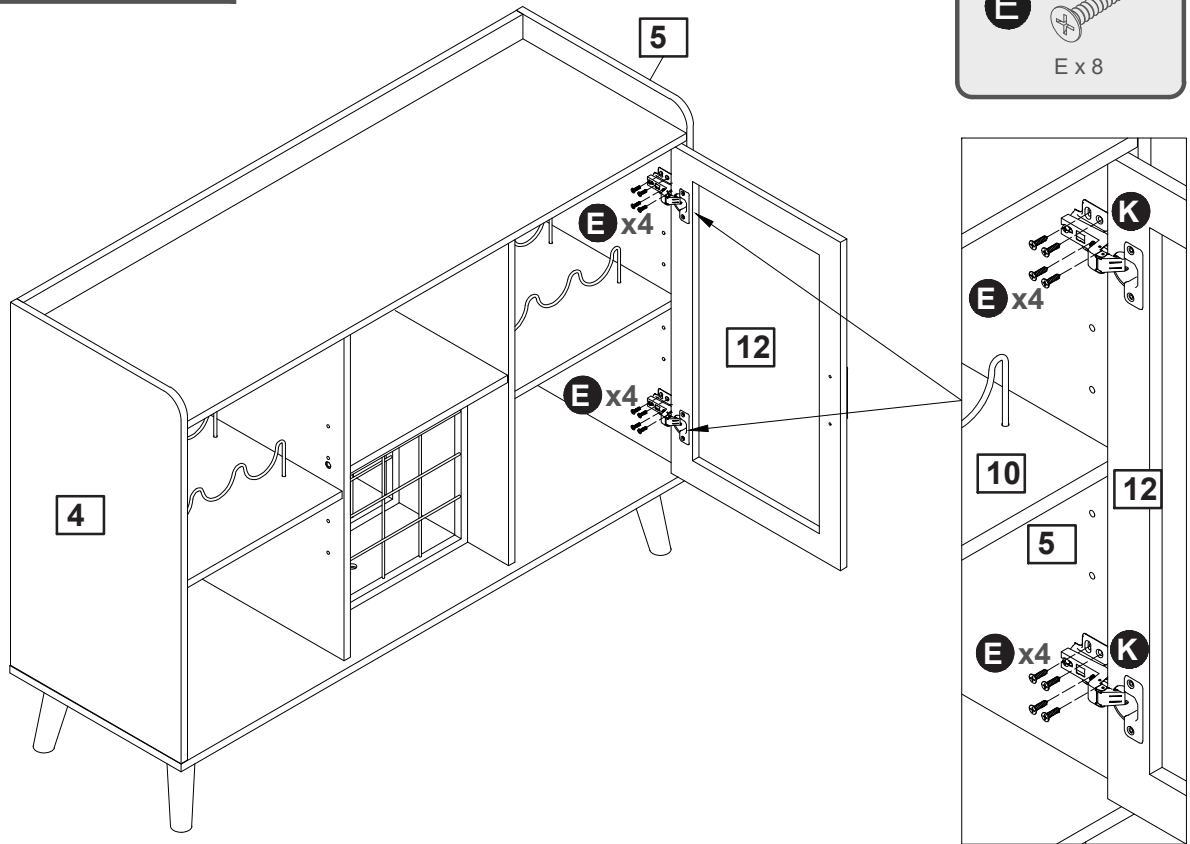

## Step 26

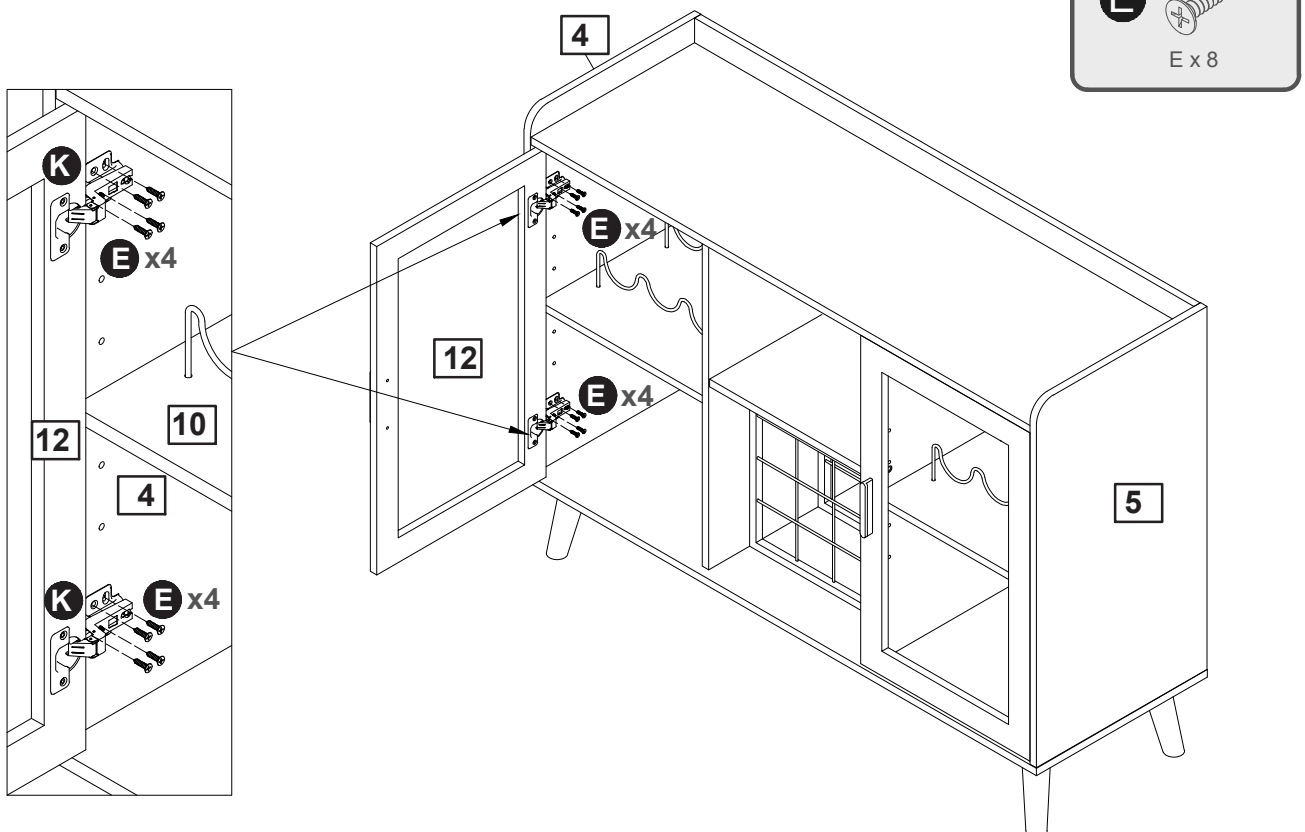

# Assembly Instructions

## Step 27

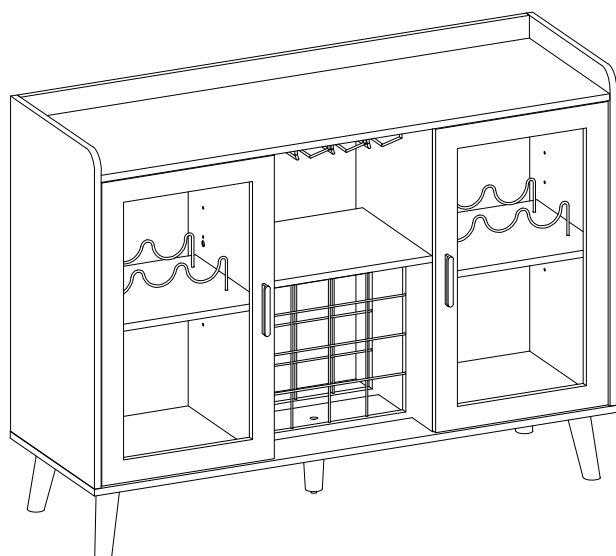
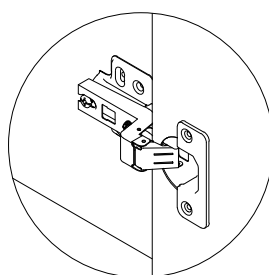
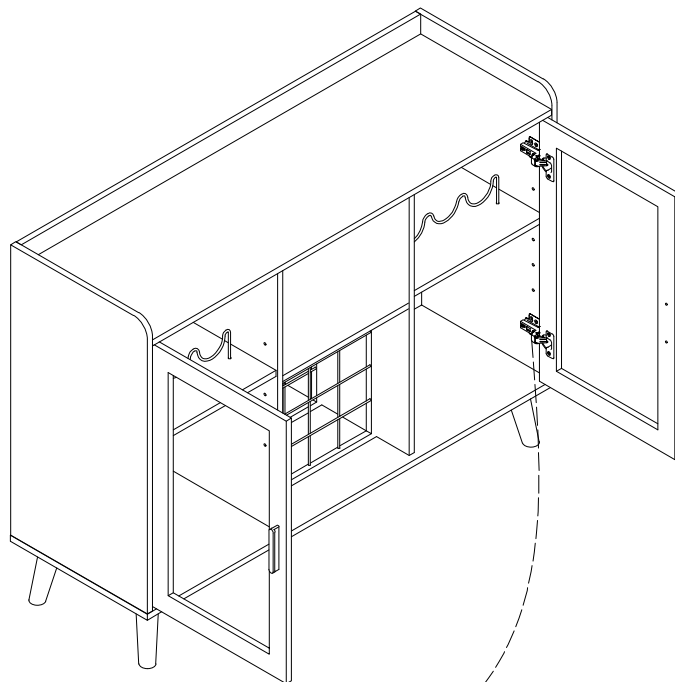
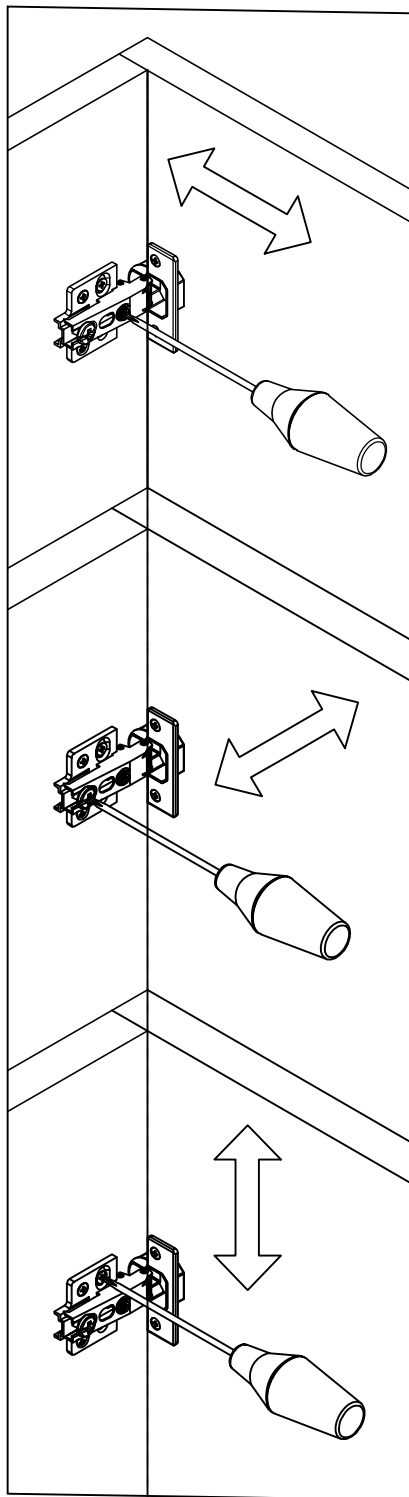

# Assembly Instructions

## Step 28

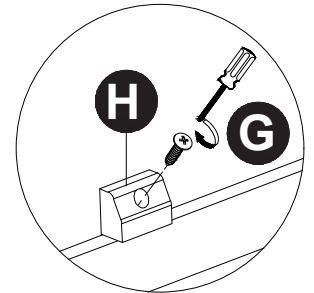
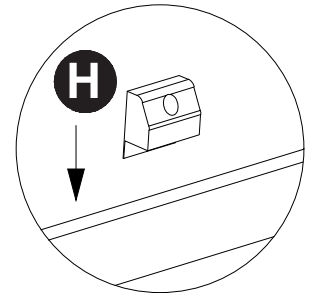
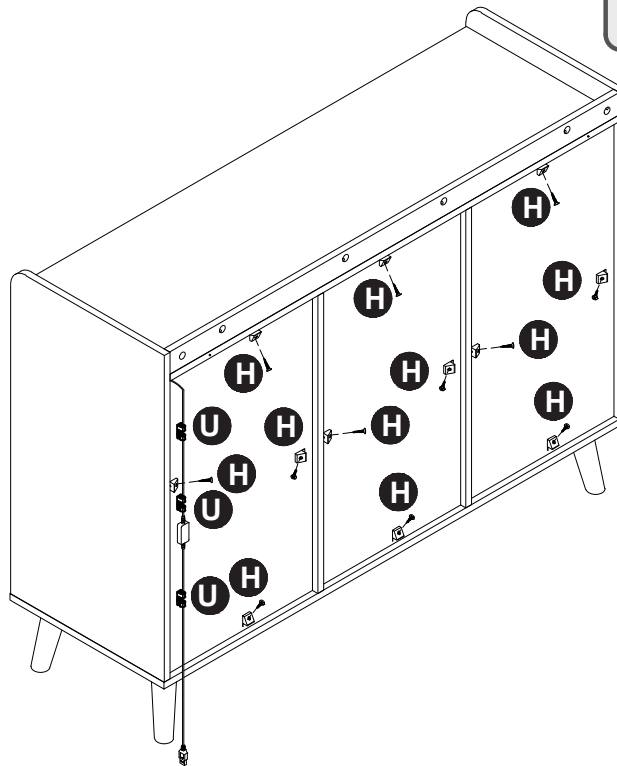
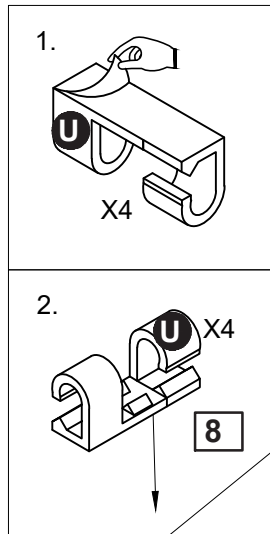
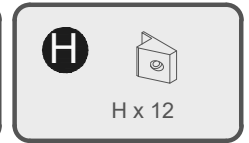

## Step 29

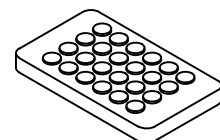
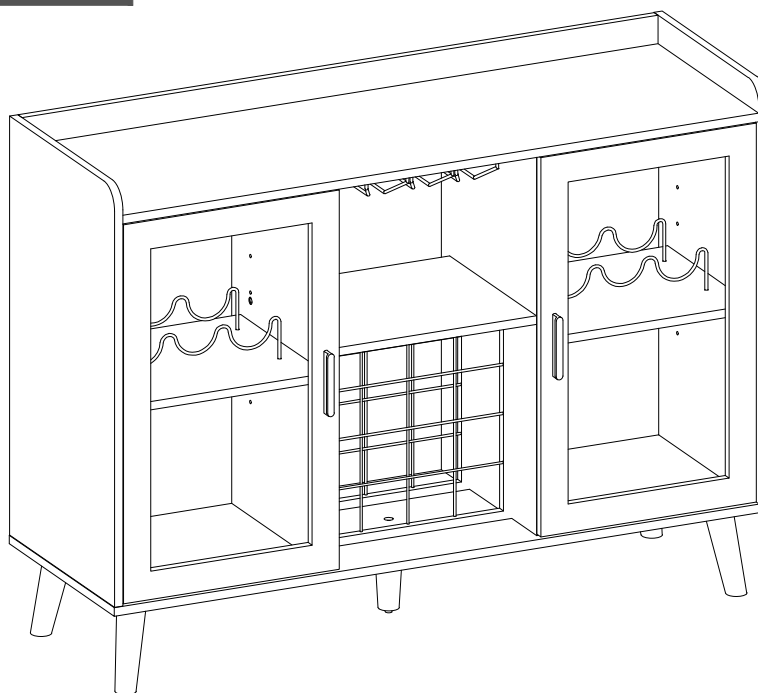

Effective distance of light control: within 3 meters

# Assembly Instructions

## Step 30

The unit is floor standing, but it is recommended that the unit is secured to the wall.

1. Move the unit into desired position.
2. Mark the wall with a suitable scribe the position of the fixing holes.



**Warning:**  
Before drilling, check wall for hidden pipes and cables.

3. Drill holes and insert 2 x wall plug
4. Secure the 2 wall straps to the top of the unit using 2 washers and 2 screws.
5. Secure the straps to the wall using 2 x Washers and 2 x Screws

**Note:** To hide the straps behind the unit, drill the holes lower than the top of the unit

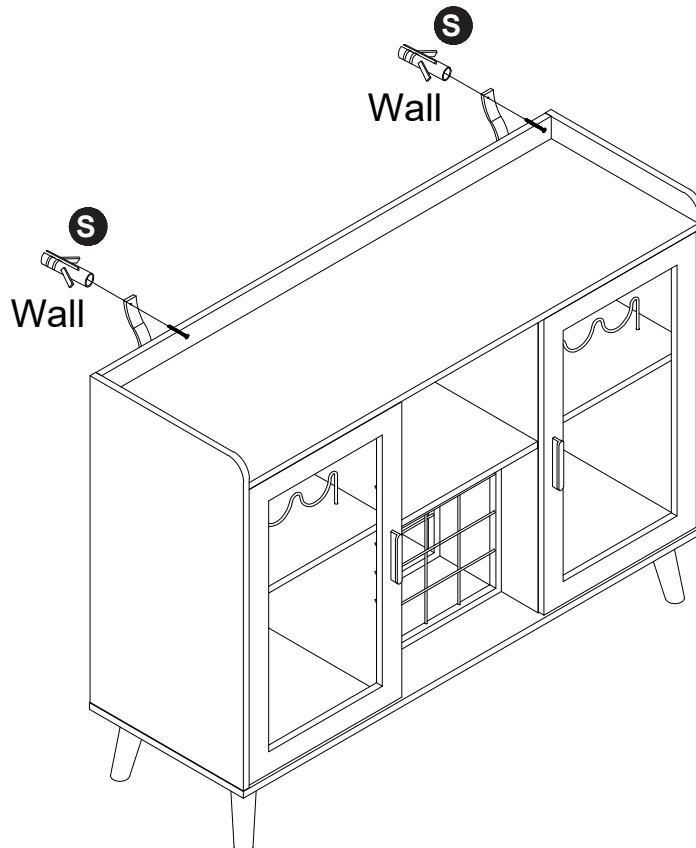
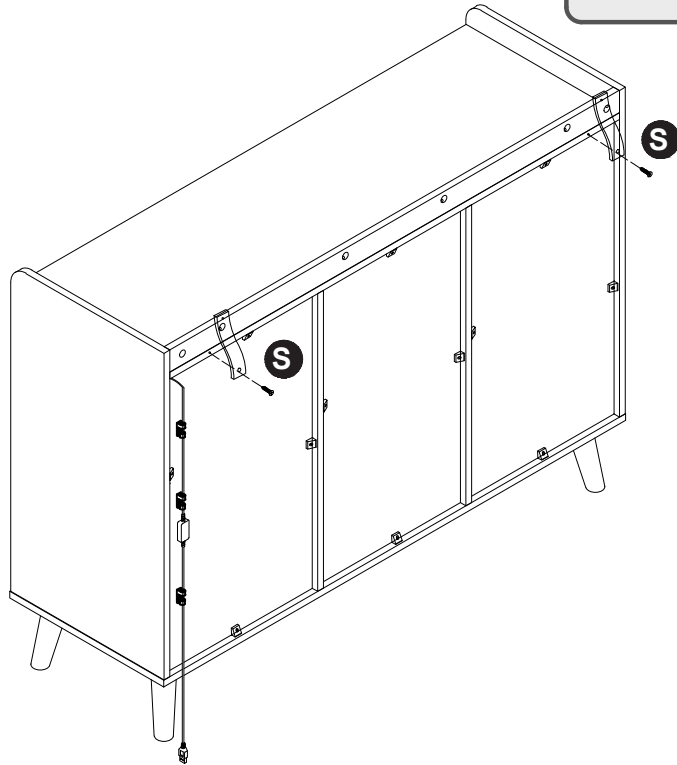

Assembly is complete.