

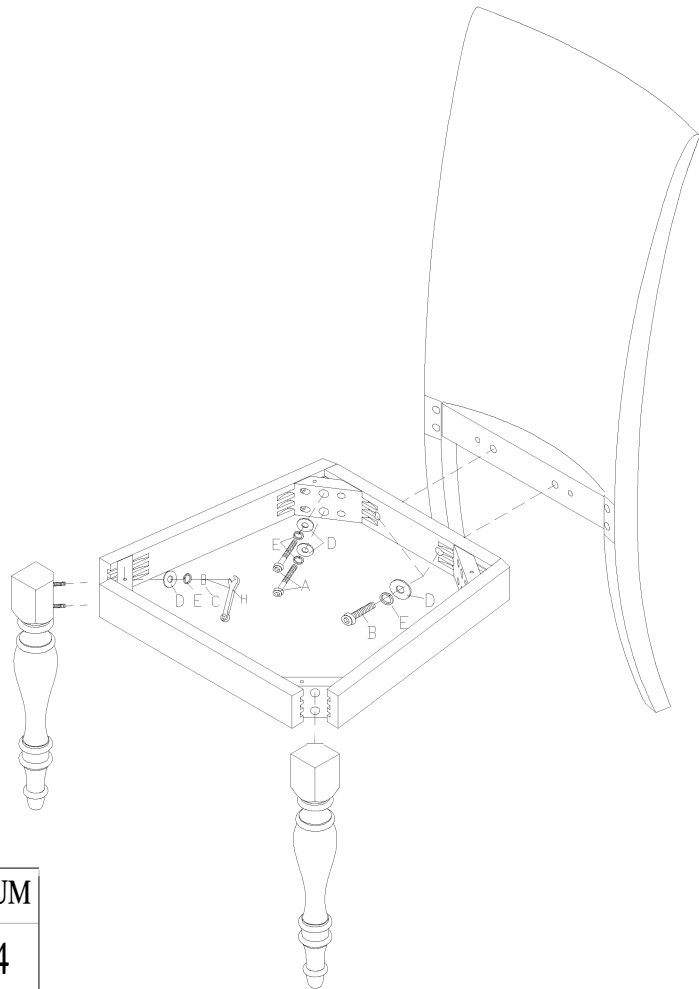

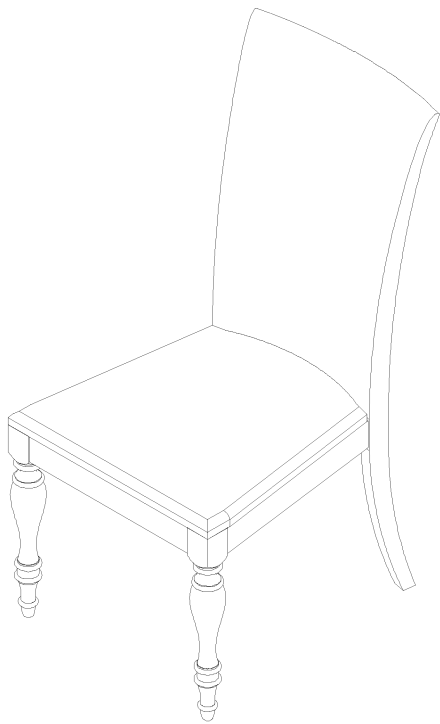





ASSEMBLY INSTRUCTION

75/76 - 065 UPHOLSTERED SIDE CHAIR

IMPORTANT NOTES :

- . Place all wooden parts on a clean and smooth surface such as a rug or carpet to prevent the parts from being scratched.
- . Check to be sure that you have all parts and hardware.
- . Remove all wrapping materials, including staples and packing straps before you start to assemble.
- . Do not tighten all screws and bolts until completely assembled.
- . Keep all hardware out of the reach of children.



CODE	DESCRIPTION	NUM
A	 Bolt 5/16"*3-1/2"	4
B	 Bolt 5/16"*2"	2
C	 Nut	4
D	 Flat washer	10
E	 Lock washer	10
G	 Allen Key	1
H	 Wrench	1

MADE IN VIETNAM