

Assembly Instructions

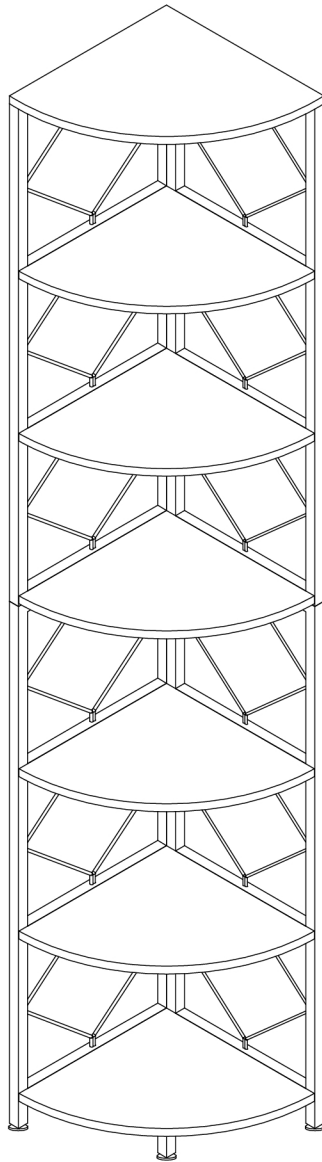

Warm Tips

EN

1. Carefully read and keep these instructions for later.
2. Before assembling, ensure all parts and accessories are there.
3. Assemble on a soft, smooth surface like a carpet to avoid scratches.
4. Don't fully tighten the screws until everything is correctly in place.

DE

1. Lesen Sie diese Anleitung sorgfältig durch und bewahren Sie sie für später auf.
2. Stellen Sie vor dem Zusammenbau sicher, dass alle Teile und Zubehörteile vorhanden sind.
3. Montieren Sie es auf einer weichen, glatten Oberfläche wie einem Teppich, um Kratzer zu vermeiden.
4. Ziehen Sie die Schrauben nicht vollständig an, bis alles richtig sitzt.

IT

1. Leggere attentamente e conservare le presenti istruzioni.
2. Prima di procedere al montaggio, accertarsi che tutte le parti e gli accessori siano presenti.
3. Montare su una superficie morbida e liscia, come un tappeto, per evitare graffi.
4. Non serrare completamente le viti finché tutto non è stato posizionato correttamente.

FR

1. Lisez attentivement ces instructions et conservez-les.
2. Avant de procéder à l'assemblage, assurez-vous que toutes les pièces et tous les accessoires sont présents.
3. Effectuez l'assemblage sur une surface douce et lisse, comme un tapis, pour éviter les rayures.
4. Ne serrez pas complètement les vis tant que tout n'est pas correctement en place.

ES

1. Lea atentamente estas instrucciones y consérvelas para más adelante.
2. Antes de ensamblar, asegúrese de que todas las piezas y accesorios estén en su lugar.
3. Ensamble sobre una superficie suave y lisa, como una alfombra, para evitar rayones.
4. No ajuste completamente los tornillos hasta que todo esté correctamente colocado.

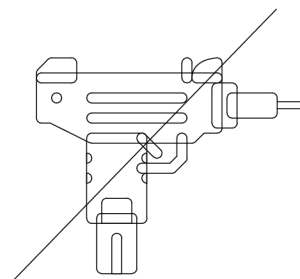
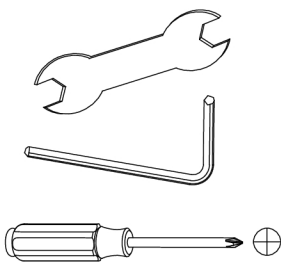
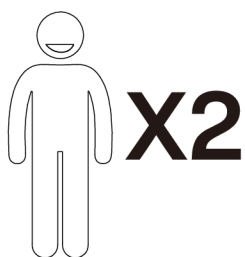

EN - We recommend using hand tools for assembly.
If an electric screwdriver is used, reduce its power to protect the product.

DE - Wir empfehlen die Verwendung von Handwerkzeugen für die Montage.
Wenn ein elektrischer Schraubendreher verwendet wird, reduzieren Sie die Leistung, um das Produkt zu schützen.

IT - Per l'assemblaggio si consiglia di utilizzare utensili manuali.
Se si utilizza un cacciavite elettrico, ridurne la potenza per proteggere il prodotto.

FR - Nous recommandons d'utiliser des outils manuels pour l'assemblage.
Remarque: Si un tournevis électrique est utilisé, réduisez sa puissance pour protéger le produit.

ES - Recomendamos utilizar herramientas manuales para el montaje.
Si se utiliza destornillador eléctrico, reduzca la potencia y el par de torsión para evitar dañar el producto.

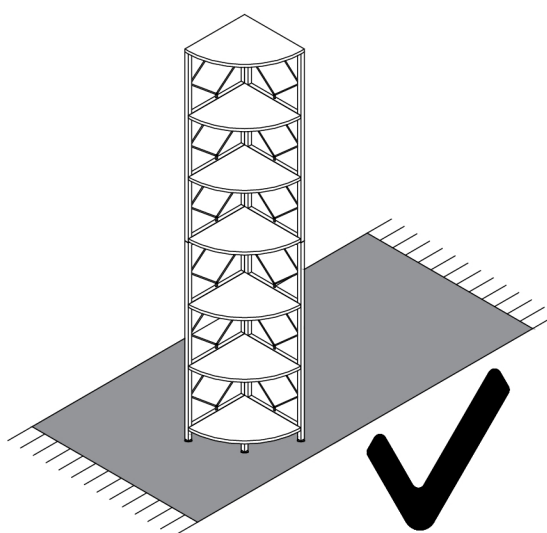
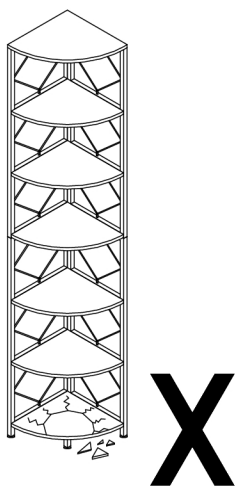
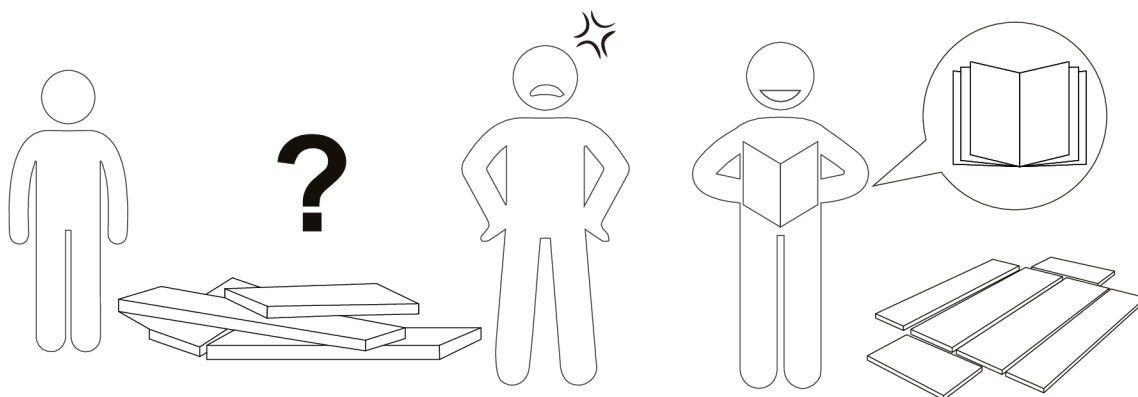

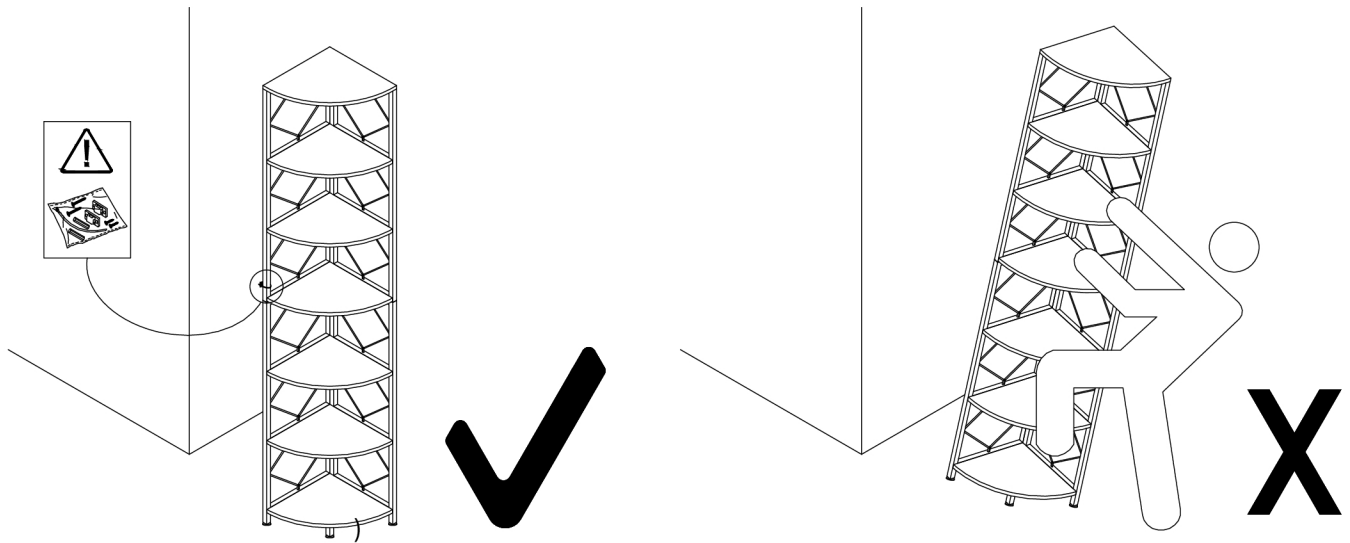

EN - Install tip-over restraint provided

Use of tip-over restraints may only reduce but not eliminate the risk of tip-over.

DE - Installieren Sie eine Kippsicherung

Die Verwendung von Kippsicherungen kann das Risiko eines Kippens zwar reduzieren, aber nicht vollständig beseitigen.

IT - Installare il sistema di ritenuta antiribaltamento fornito

L'uso di sistemi di ritenuta antiribaltamento può solo ridurre, ma non eliminare, il rischio di ribaltamento.

FR - Installer le dispositif anti-basculement fourni

L'utilisation de dispositifs anti-basculement peut réduire, mais non éliminer, le risque de basculement.

ES - Instalar dispositivos antivuelco

El uso de dispositivos antivuelco puede reducir el riesgo de vuelco, pero no puede eliminarlo por completo.

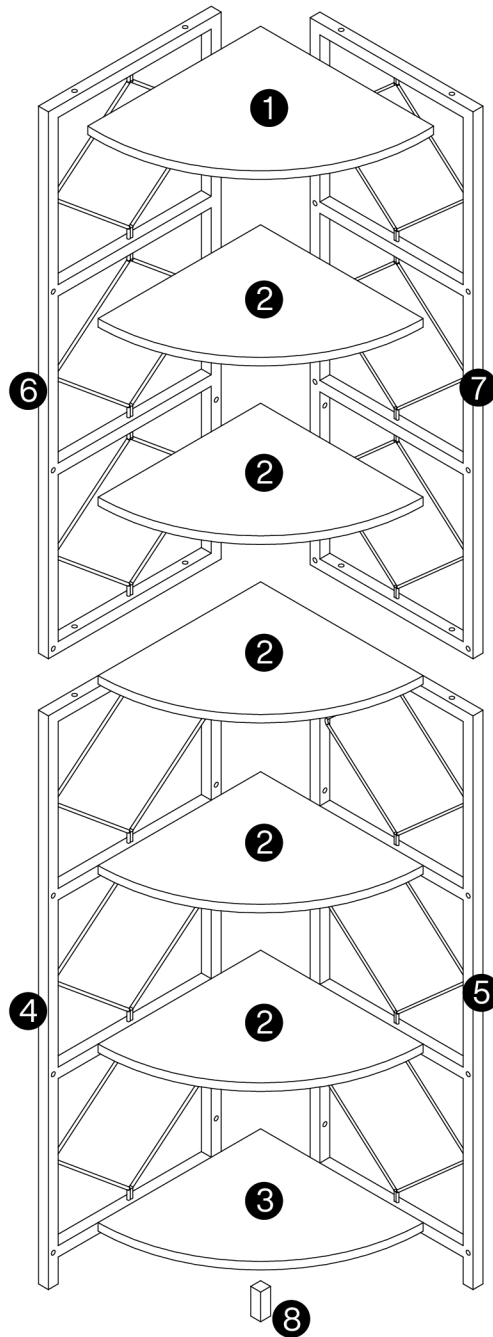

⚠ Caution

EN - Check all parts. Most board parts are labeled on the edge.
Contact us for a free replacement if any are damaged or missing.



DE - Bitte überprüfen Sie alle Teile. Die meisten Platinenteile sind am Rand beschriftet.
Bitte kontaktieren Sie uns für einen kostenlosen Ersatz, falls etwas fehlt oder beschädigt ist.

IT - Controllare tutte le parti. La maggior parte delle parti della scheda sono etichettate sul bordo.
Contattateci per ottenere una sostituzione gratuita se uno di essi è danneggiato o mancante.





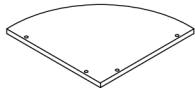
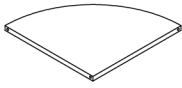
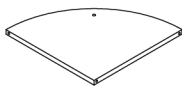
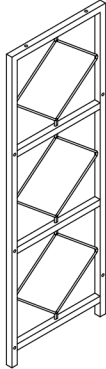
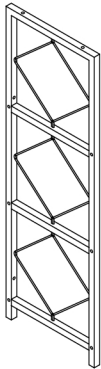
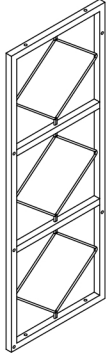
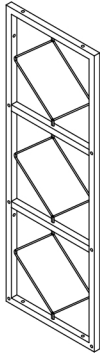



FR - Vérifiez toutes les pièces. La plupart des pièces de la carte sont étiquetées sur le bord.
Contactez-nous pour un remplacement gratuit si l'une d'entre elles est endommagée ou manquante.

ES - Asegúrate de que todas las piezas estén incluidas. La mayoría de las piezas de la tabla están etiquetadas y estampadas en el borde sin rematar.
Contáctanos para obtener un reemplazo gratuito si encuentras piezas dañadas o faltantes.

EN - Parts List | DE - Teilleiste | IT - Elenco parti | FR - Les Pièces | ES - Lista de Piezas

 <p>1 1pc</p>	 <p>2 5pcs</p>	 <p>3 1pc</p>	 <p>4 1pc</p>
 <p>5 1pc</p>	 <p>6 1pc</p>	 <p>7 1pc</p>	 <p>8 1pc</p>

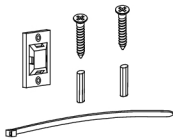
EN - Hardware List | DE - Hardwareliste | IT - Hardware Elenco | FR - Le Matériel | ES - Lista de Hardware

 <p>B 18pcs</p>	 <p>F 4pcs</p>	 <p>I 8pcs</p>	 <p>T 1pc</p>	 <p>V 8pcs</p>
 <p>Y 4pcs</p>	 <p>Z 2pcs</p>			

1

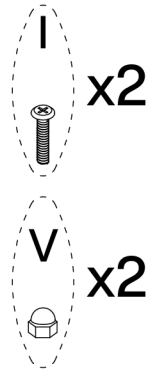
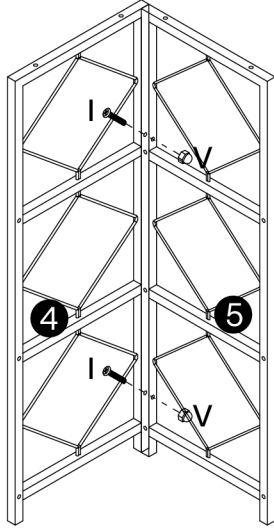

2

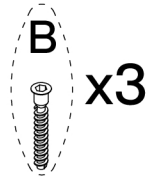
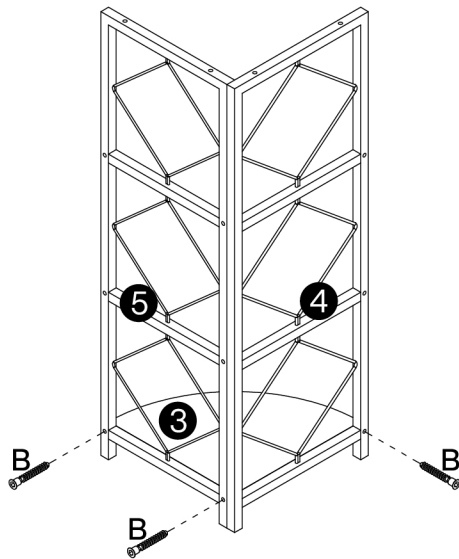

3

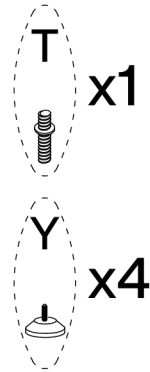
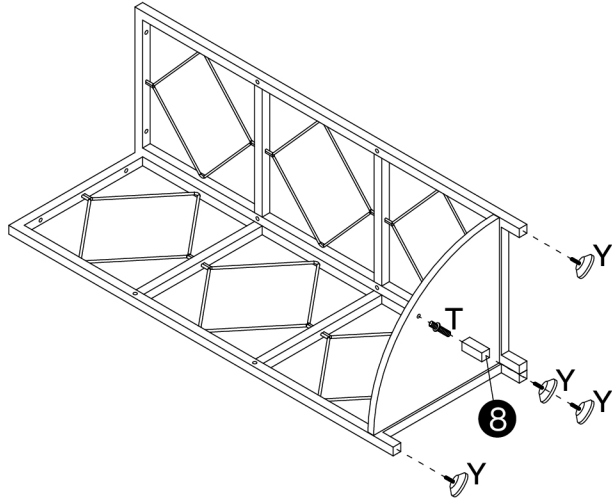

4

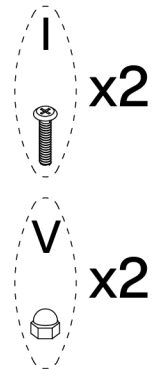
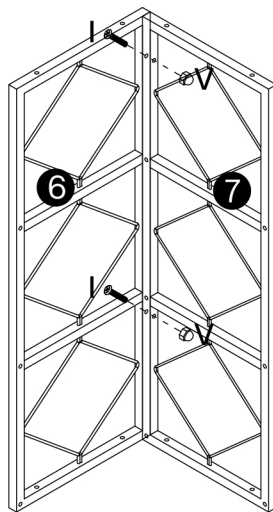

5

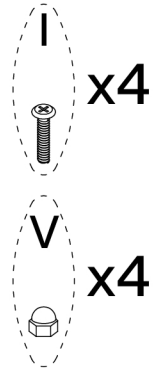
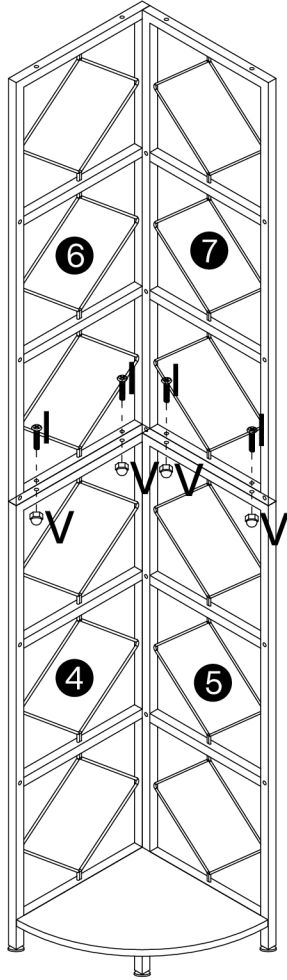

6

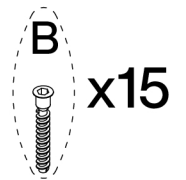
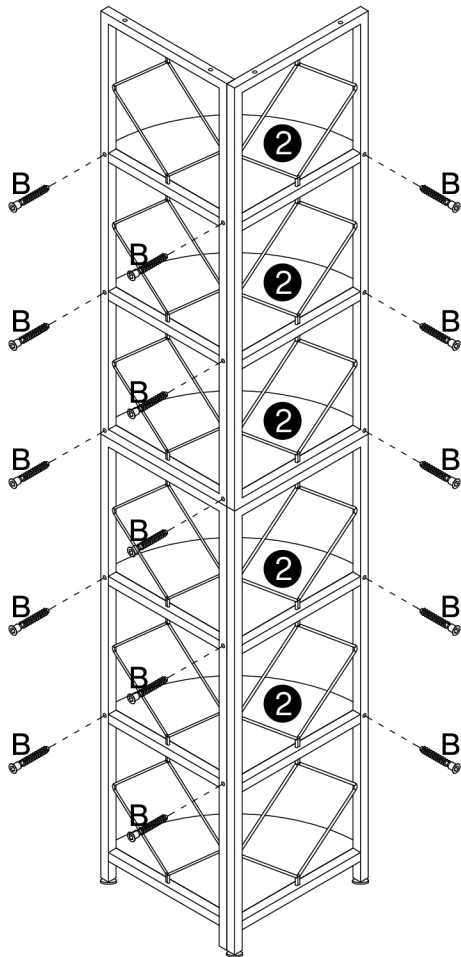

7

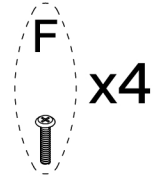
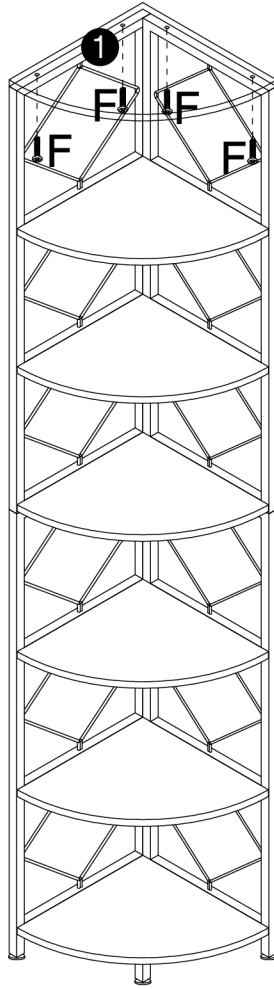

8

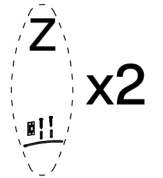
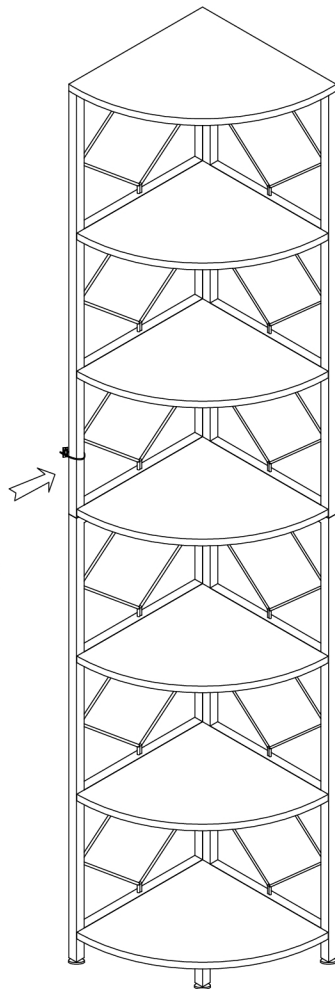
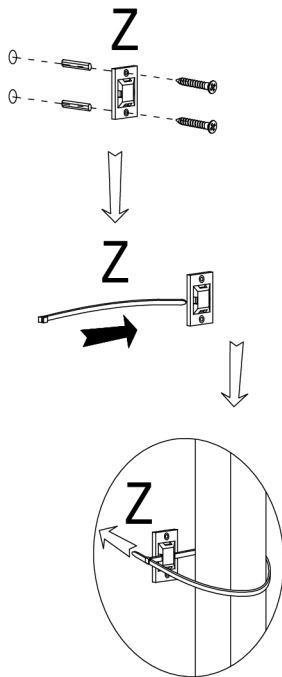

Thank you for your support!

