



# CAUTION

## **Please do not return this item to the store where it was purchased**

We appreciate your selection of our product. You can have confidence in this product that incorporates quality components. Please do not return this item to where it was purchased, if any question, please contact our Customer Service Department

## **Quality statement**

It is appreciated your selection of this product, we know you had many other choices. Please pay attention that proper care and cleaning at home will extend the life of your purchase. Following these important and helpful tips will enhance your furniture as it ages.

## **Upholstered furniture care instructions**

- Vacuum your upholstered furniture regularly. Small dust particles are very abrasive and can wear furniture prematurely.
- Blot spills immediately to prevent staining. If necessary, gently wipe away the spill using a soft, clean cloth dampened with lukewarm water. Allow to dry and brush lightly.
- Never use harsh chemicals or solvents on your upholstered furniture as this may damage the finish.
- Never use water to clean your furniture as it may cause damage to the finish.
- If you choose to use a professional product, pretest the fabric in an inconspicuous area for any signs of discoloration or shrinking.
- Marks and stains from pens, crayons and ink markers are difficult to remove. In the event that your furniture becomes permanently stained, we recommend that you consult a professional expert.

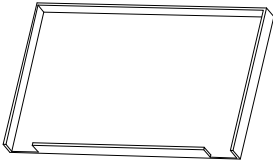
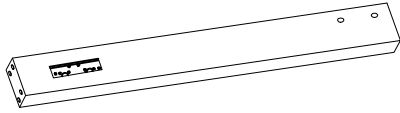
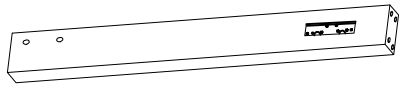
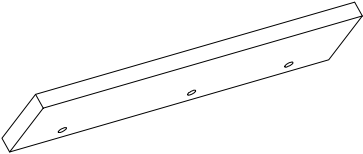
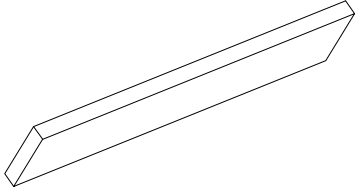
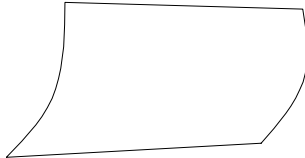

## PARTS LIST

PLEASE ALWAYS CHECK EVERY PART BEFORE ASSEMBLY

A	1 PCE	L	1 PCE	R	1 PCE
Headboard Panel		Left Leg		Right Leg	
					
B	1 PCE	C	1 PCE	D	1 PCE
Left Wing Back		Right Wing Back		Back Cover	
					

## Hardware List

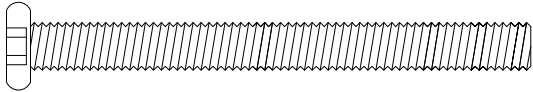
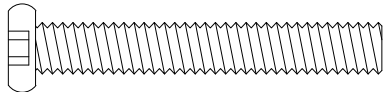
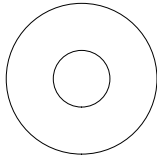
NOTE: HARDWARE NOT SHOWN TO ACTUAL SIZE IN THE FIGURES BELOW

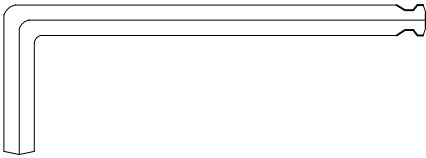
①	4 PCS	②	6 PCS	③	10 PCS
Ø1/4" x 2-1/2" L Allen Bolts		Ø1/4" x 1-3/4" L Allen Bolts		Flat Washers	
					
④	10 PCS	⑤	1 PCE		
Spring Washers		Allen Wrench			
					

This page lists all contents included in the box. Please take a few minutes to identify the hardware as well as the individual components of this product. As you unpack and prepare for assembly, place the contents on a carpet or padded area to protect them from damage.

- Tips:
1. For ensuring the entire unit will properly align, secure all the bolts 80% tight, adjust the unit to be evenly aligned, then secure all the bolts completely and tightly.
  2. Please also check the thickness of your mattress and box spring before your assembly.

**Step1:**  
**Assemble the Wing Backs (B & C) & the Headboard Panel (A).**

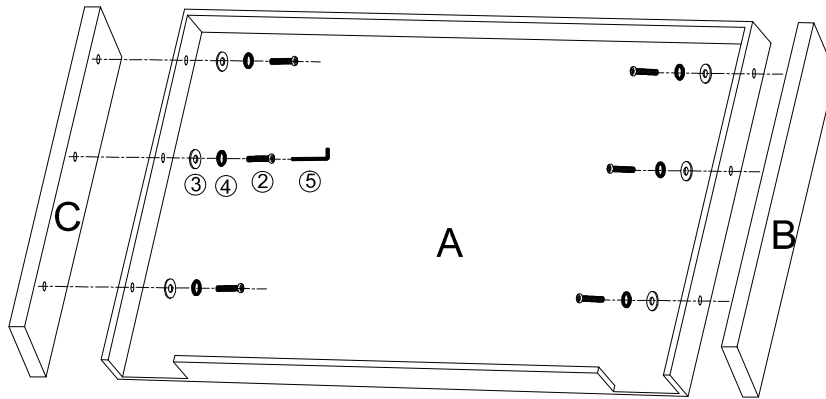

②

6 PCS

Ø1/4" x 1-3/4" L Allen Bolts

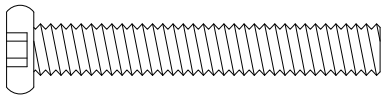

③

6 PCS

Flat Washers

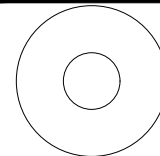

④

6 PCS

Spring Washers



⑤

1 PCE

Allen Wrench



**Step2:**  
**Assemble the Headboard Panel (A)**  
**and the Legs (R & L).**

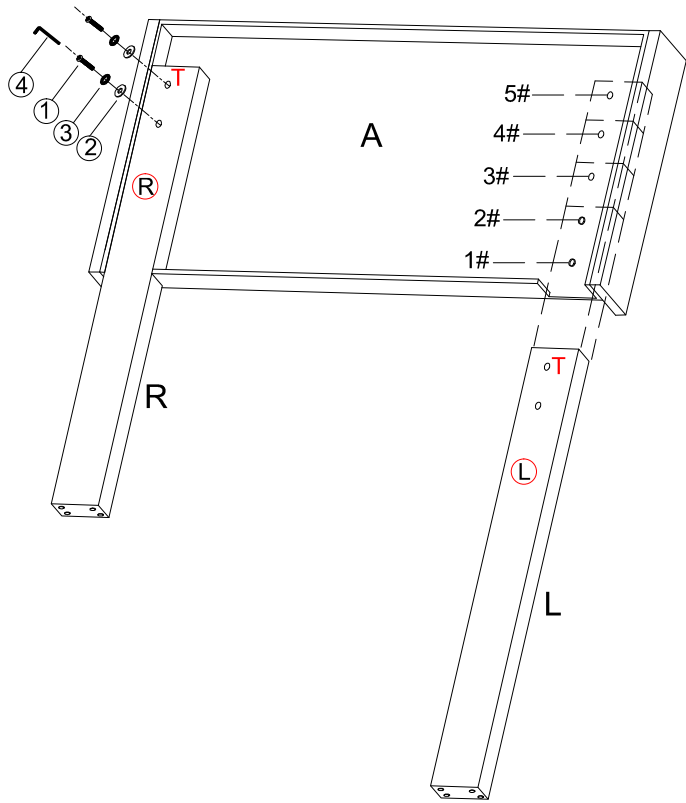

**IMPORTANT!**  
 Please check your box spring  
 and / or mattress thickness  
 before your assembly.

Box Spring + Mattress	Adjustable Headboard Height
Under 14"	T match 5#
14"~18"	T match 4#
18"~22"	T match 3#
22"~26"	T match 2#
26"~UP	T match 1#

①

4 PCS

Ø1/4" x 2-1/2" L Allen Bolts

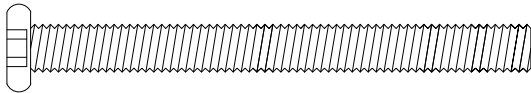

③

4 PCS

Flat Washers

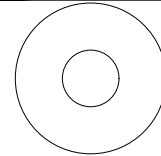

④

4 PCS

Spring Washers



⑤

1 PCE

Allen Wrench



Step 3:  
Cover the fabric lining behind the headboard.

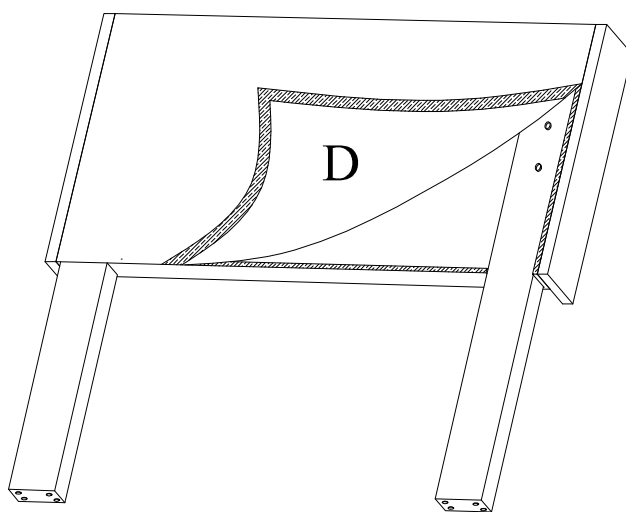

Stand the unit upright, adjust the legs on each side, then tighten all bolts.