

ASSEMBLY INSTRUCTIONS
COASTER FINE FURNITURE



Fine Furniture for every stage of life

224731Q (B1&B2)
Queen Bed

ITEM: 224731Q (B1&B2)



ASSEMBLY INSTRUCTIONS

ASSEMBLY TIPS:

1. Remove hardware from box and sort by size.
2. Please check to see that all hardware and parts are present prior to start of assembly.
3. Please follow attached instructions in the same sequence as numbered to assure fast & easy assembly.



WARNING!

1. Don't attempt to repair or modify parts that are broken or defective. Please contact the store immediately.
2. This product is for home use only and not intended for commercial establishments.









ASSEMBLY TIME

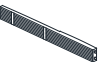

30 MINUTES

PARTS IDENTIFICATION

B1 (BOX 1)

A	HEADBOARD PANEL		1PC	E	FOOTBOARD LEG		2PCS
B	LEFT HEADBOARD LEG (WITH "L" LABEL)		1PC	F	BED SLAT		4PCS
C	RIGHT HEADBOARD LEG (WITH "R" LABEL)		1PC	G	BED SLAT SUPPORT WITH LEVELER		4PCS
D	FOOTBOARD PANEL		1PC				

B2 (BOX 2)

H	LEFT BED RAIL (WITH "H" LABEL)		1PC	I	RIGHT BED RAIL (WITH "I" LABEL)		1PC
---	-----------------------------------	---	-----	---	------------------------------------	---	-----

NOTE:

Phillips head screw driver is required in the assembly process; however, manufacturer does not provided this item.

ITEM: 224731Q (B1&B2)



ASSEMBLY INSTRUCTIONS

ASSEMBLY TIPS:

1. Remove hardware from box and sort by size.
2. Please check to see that all hardware and parts are present prior to start of assembly.
3. Please follow attached instructions in the same sequence as numbered to assure fast & easy assembly.



WARNING!

1. Don't attempt to repair or modify parts that are broken or defective. Please contact the store immediately.
2. This product is for home use only and not intended for commercial establishments.

HARDWARE IDENTIFICATION

Z-B2 (BOX 2) - HARDWARE PACK IS LOCATED IN 224731Q (B2)

1	BOLT 1 (M8 x 20MM - RBW)		4PCS	7	SMALL FLAT WASHER (1/4" x 19 Ø - RBW)		6PCS
2	BOLT 2 (M8 x 35MM - RBW)		4PCS	8	BIG LOCK WASHER (M8 x 13MM - RBW)		4PCS
3	BOLT 4 (M6 x 35MM - RBW)		10PCS	9	BIG FLAT WASHER (M8 x 22MM - RBW)		4PCS
4	BOLT 3 (M6 x 15MM - RBW)		6PCS	10	FLAT HEAD SCREW (M4 x 32MM - RBW)		8PCS
5	WOOD DOWEL (M10 x 30MM - RBW)		4PCS	11	SMALL ALLEN WRENCH (M4 x 100MM - BLK)		1PC
6	SMALL LOCK WASHER (1/4" x 12 Ø - RBW)		6PCS	12	BIG ALLEN WRENCH (M5 x 65MM - BLK)		1PC

NOTE:

Phillips head screw driver is required in the assembly process; however, manufacturer does not provided this item.

ITEM: 224731Q (B1&B2)

ASSEMBLY INSTRUCTIONS

STEP 1

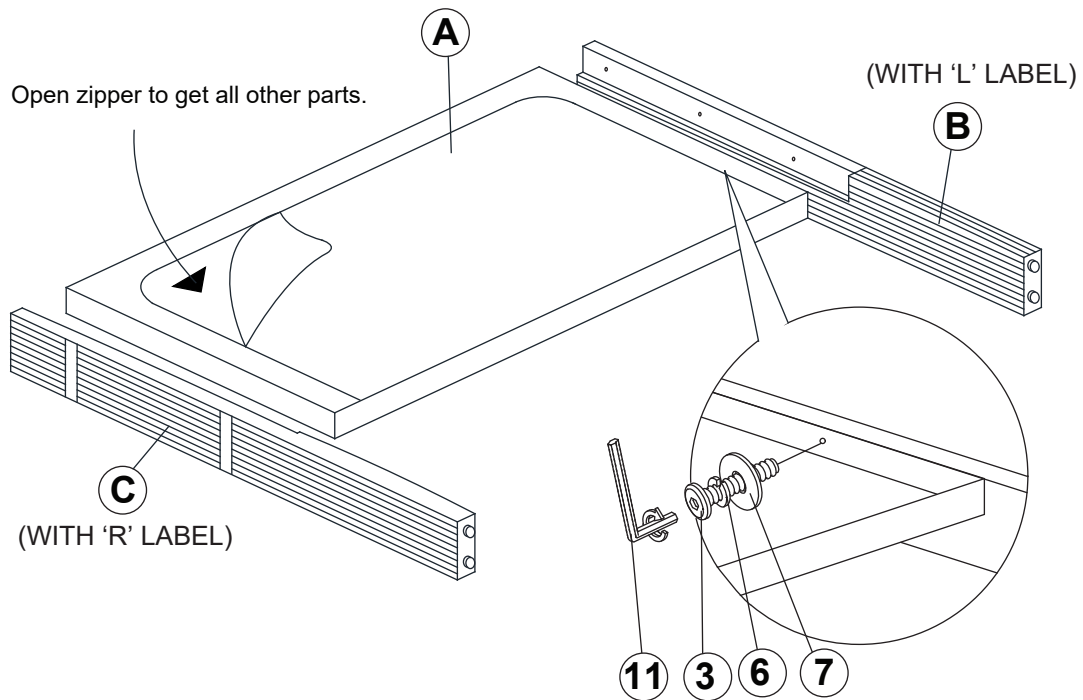

STEP 2

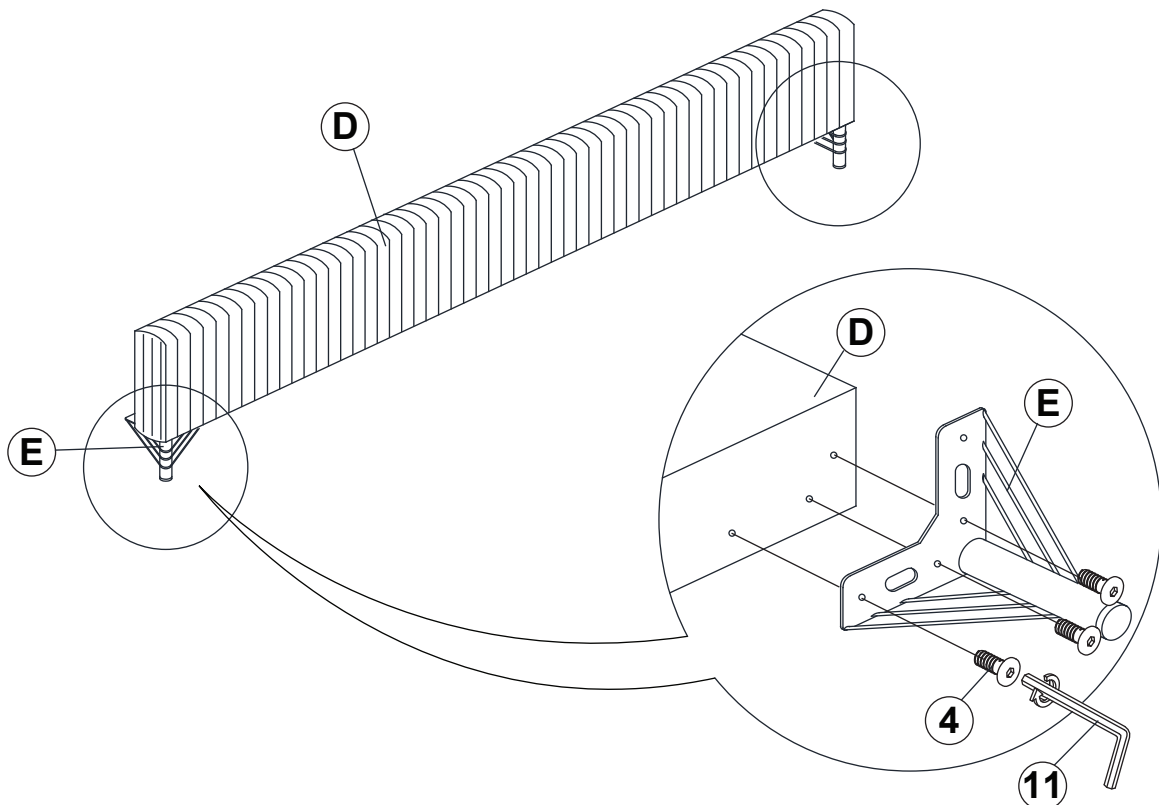

ITEM: **224731Q (B1&B2)**

ASSEMBLY INSTRUCTIONS

STEP 3

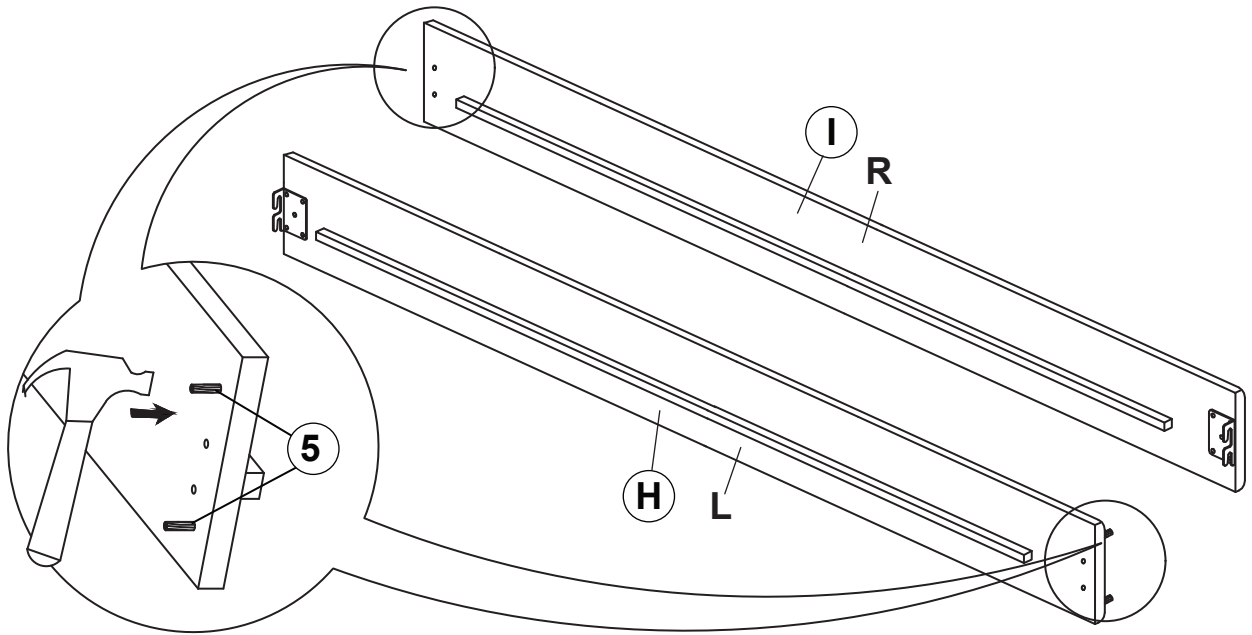

STEP 4

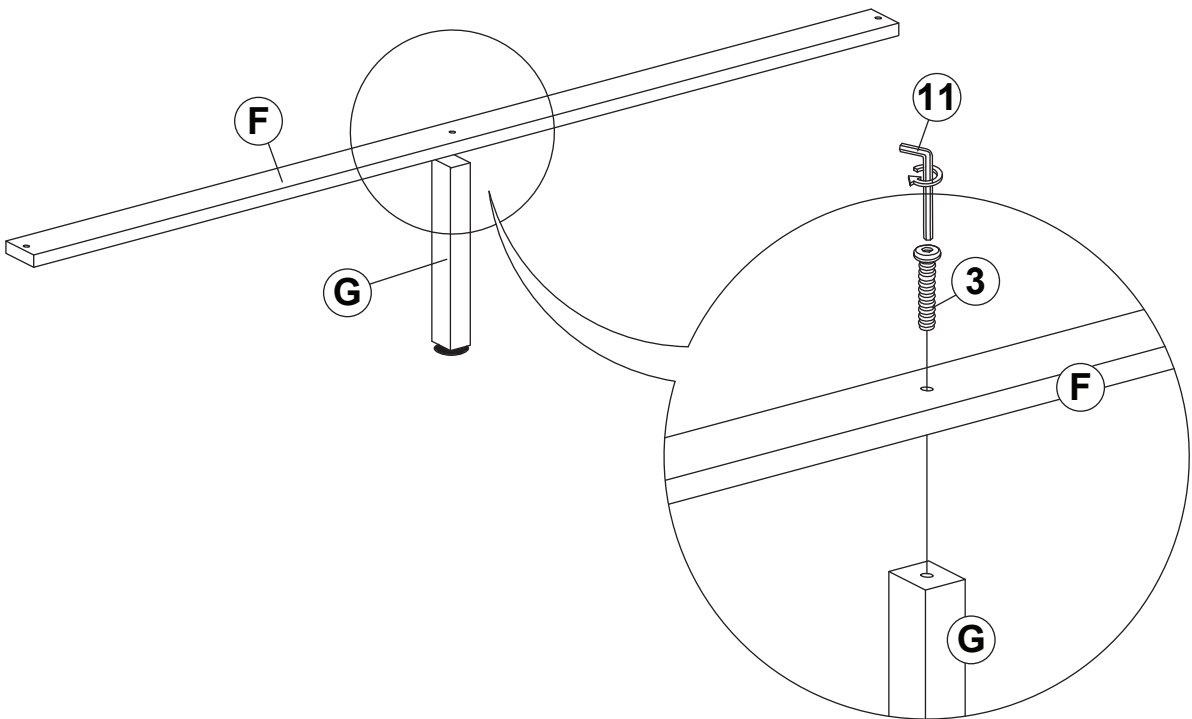

ITEM: 224731Q (B1&B2)

ASSEMBLY INSTRUCTIONS

STEP 5

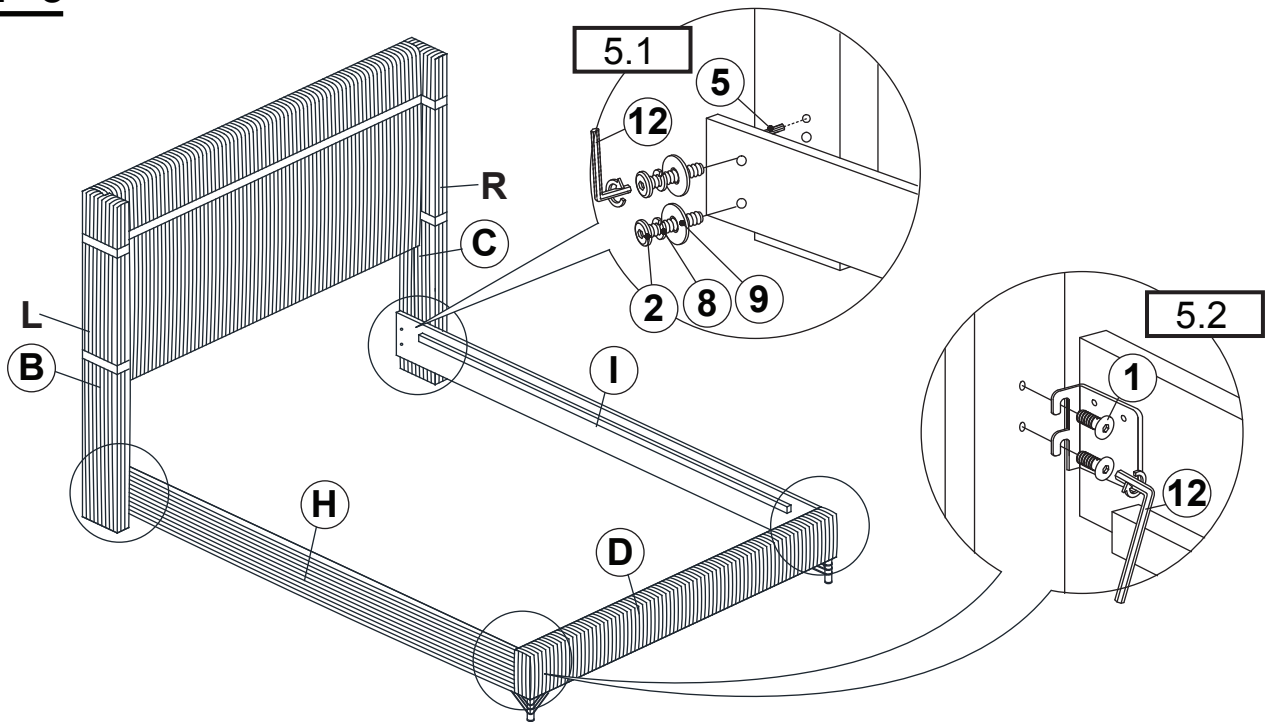

STEP 6
COMPLETE

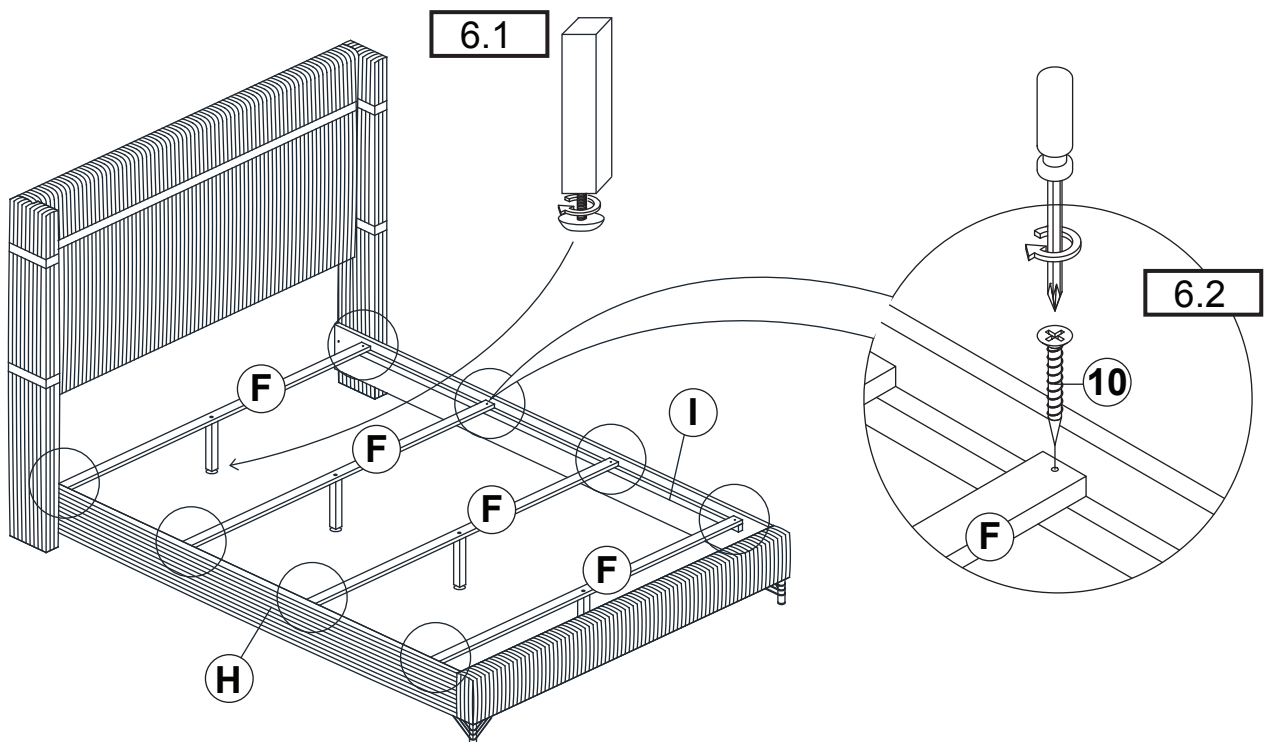

ITEM: 224731Q (B1&B2)

Inner size: 60.75"W X 81.75"D

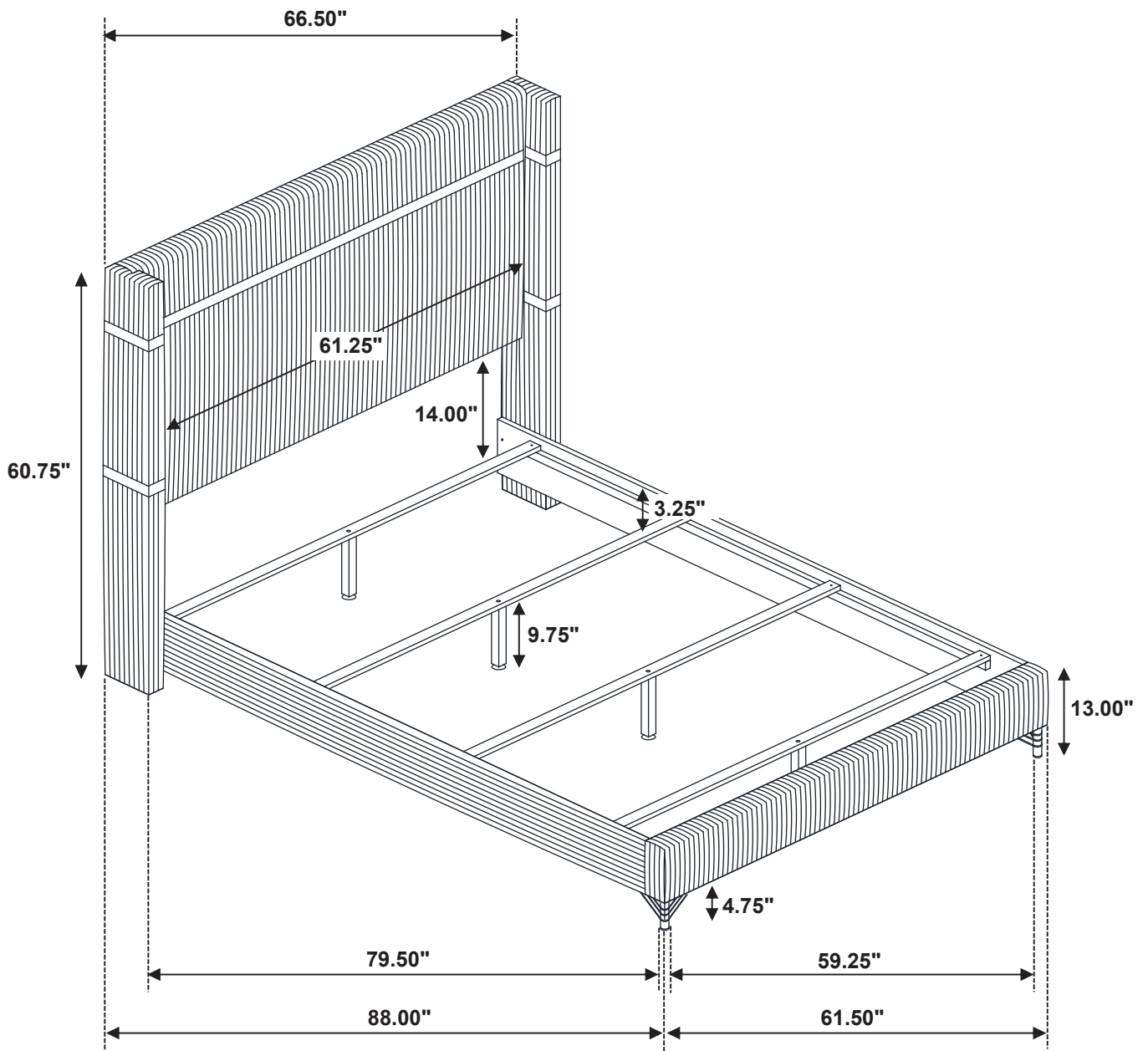

Note : Dimension tolerance $\pm 5\%$