

ASSEMBLY INSTRUCTIONS

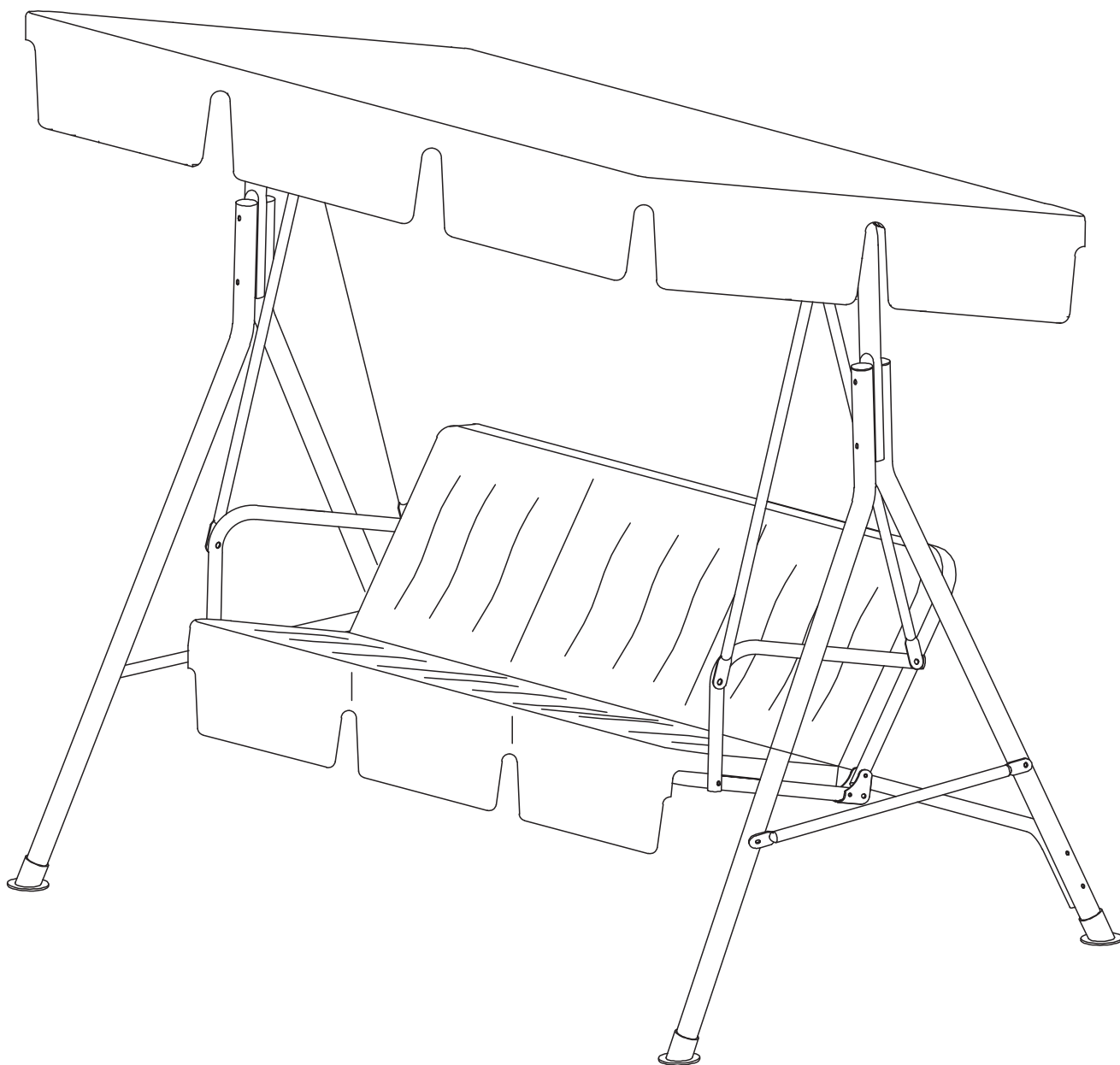







PATIO SWING/PORCH SWING

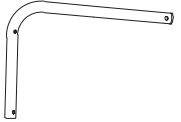

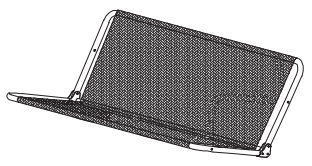
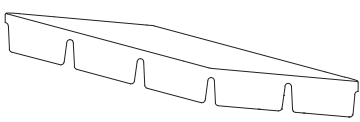

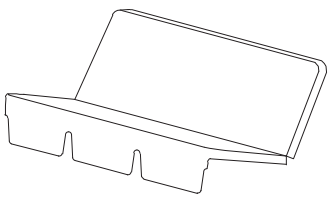

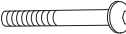
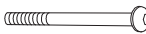
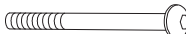

1. Two people are required for the setup.
2. A ladder and electric drill may be necessary.
3. Do not attempt to erect the structure in heavy winds or inclement weather.
4. This unit is not a permanent structure so do not leave it up for extended periods of time. It is not designed to withstand sustained wind or rain. It is a temporary, portable shelter that protects you from sunlight and rain. Screened units also block flying insects.
5. Do not use candles, matches, or any open flames in or near the tent.

Item no.	Reference Image	Qty.	Item no.	Reference Image	Qty.
A		X2	E		X2
B		X2	E1		X4
C		X1	F		X1
D		X1	G		X1
			H		X2

Item no.	Reference Image	Qty.	Item no.	Reference Image	Qty.
I		X2	L		X2
J		X1	M		X1
K		X2	N		X1

Item no.	Reference Image	Qty.
O	 M6X30mm	X1
P	 M8X40mm	X2
Q	 M6X47mm	X2

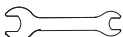
Item no.	Reference Image	Qty.
Ⓡ	 M8X60mm	X2
Ⓢ	 M8X65mm	X2
Ⓣ	 M6X68mm	X4
Ⓤ	 M6X87mm	X4
Ⓥ		M6 X15
		M8 X6
Ⓦ		M6 X15
		M8 X6
Ⓧ	 M6X52mm	X4
Ⓨ		X2
Ⓩ		M6 X15
		M8 X6
ⓐⓐ		M6 X1
		M8 X1
ⓑⓑ		X1

1



Ⓒ 1pc

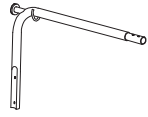

Ⓓ 1pc

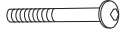

Ⓖ 2pcs



M6

Ⓥ 2pcs



M6

Ⓦ 2pcs



M6

Ⓩ 2pcs

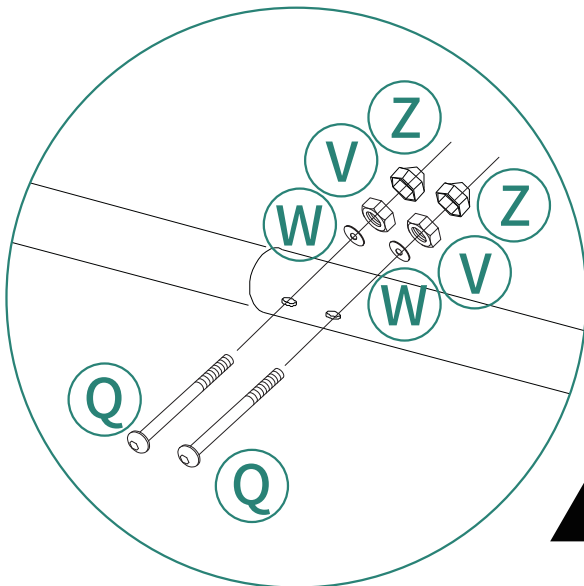
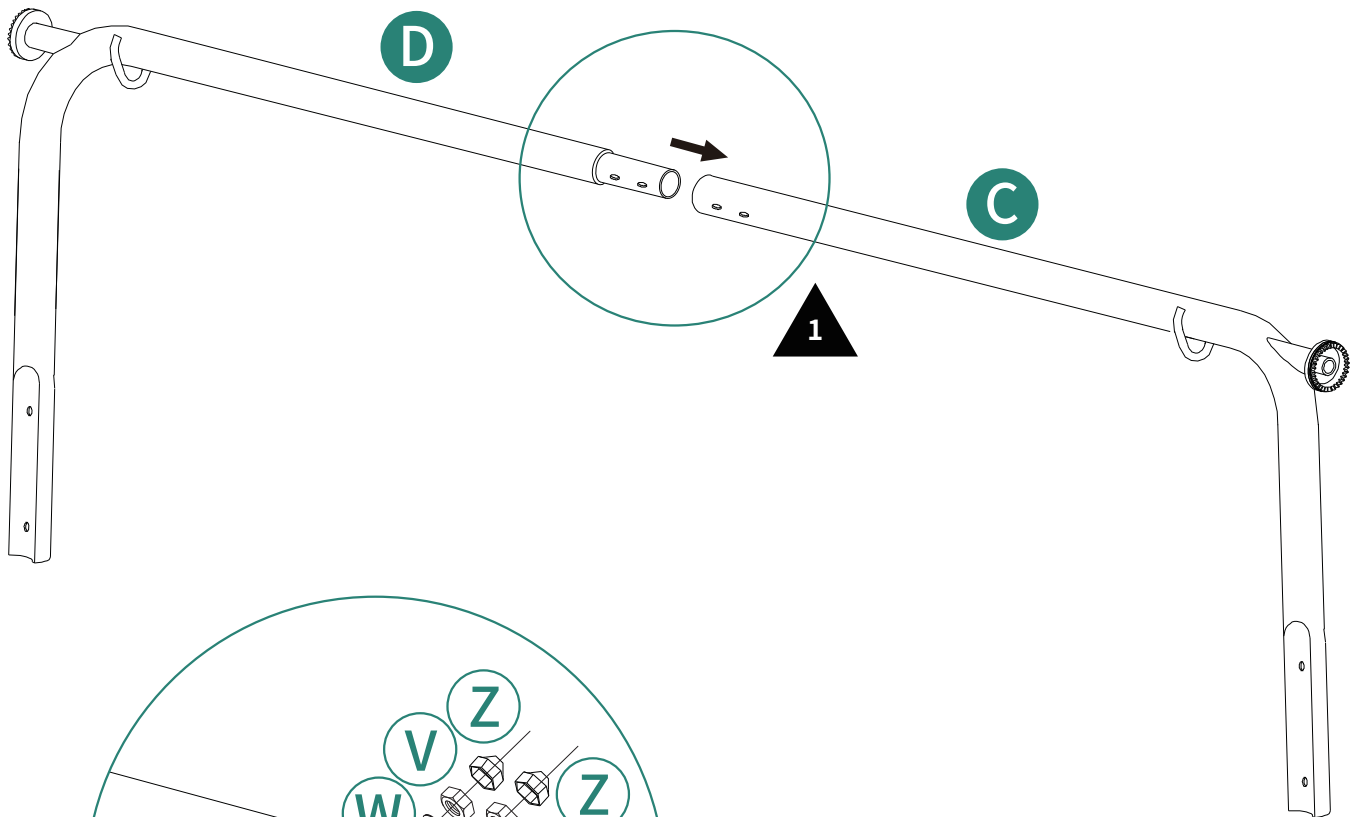



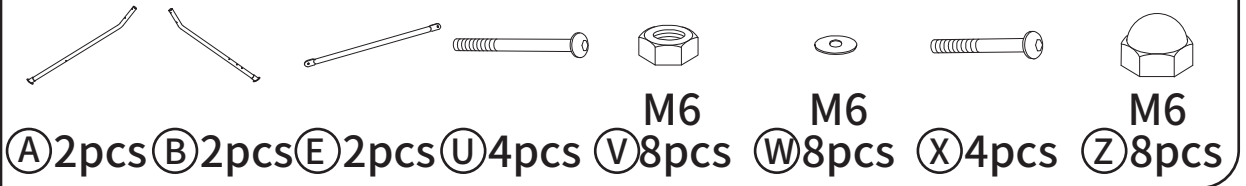

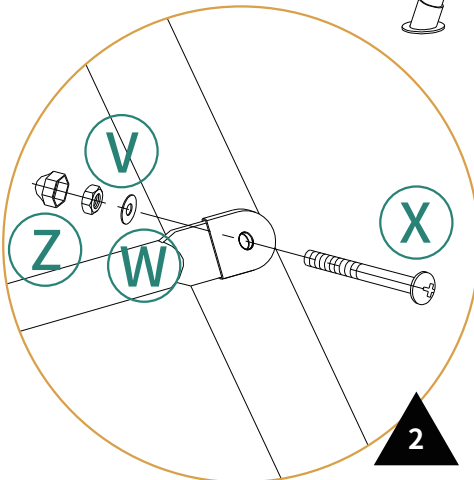
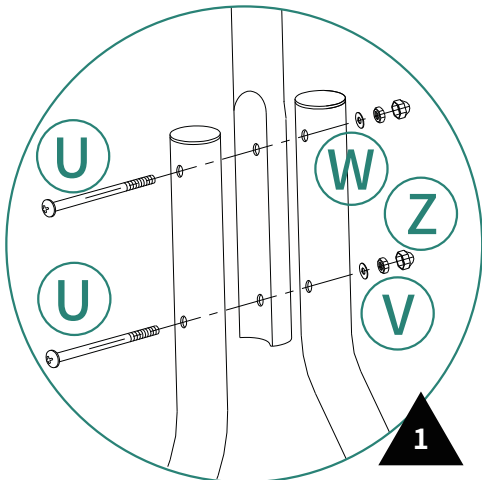
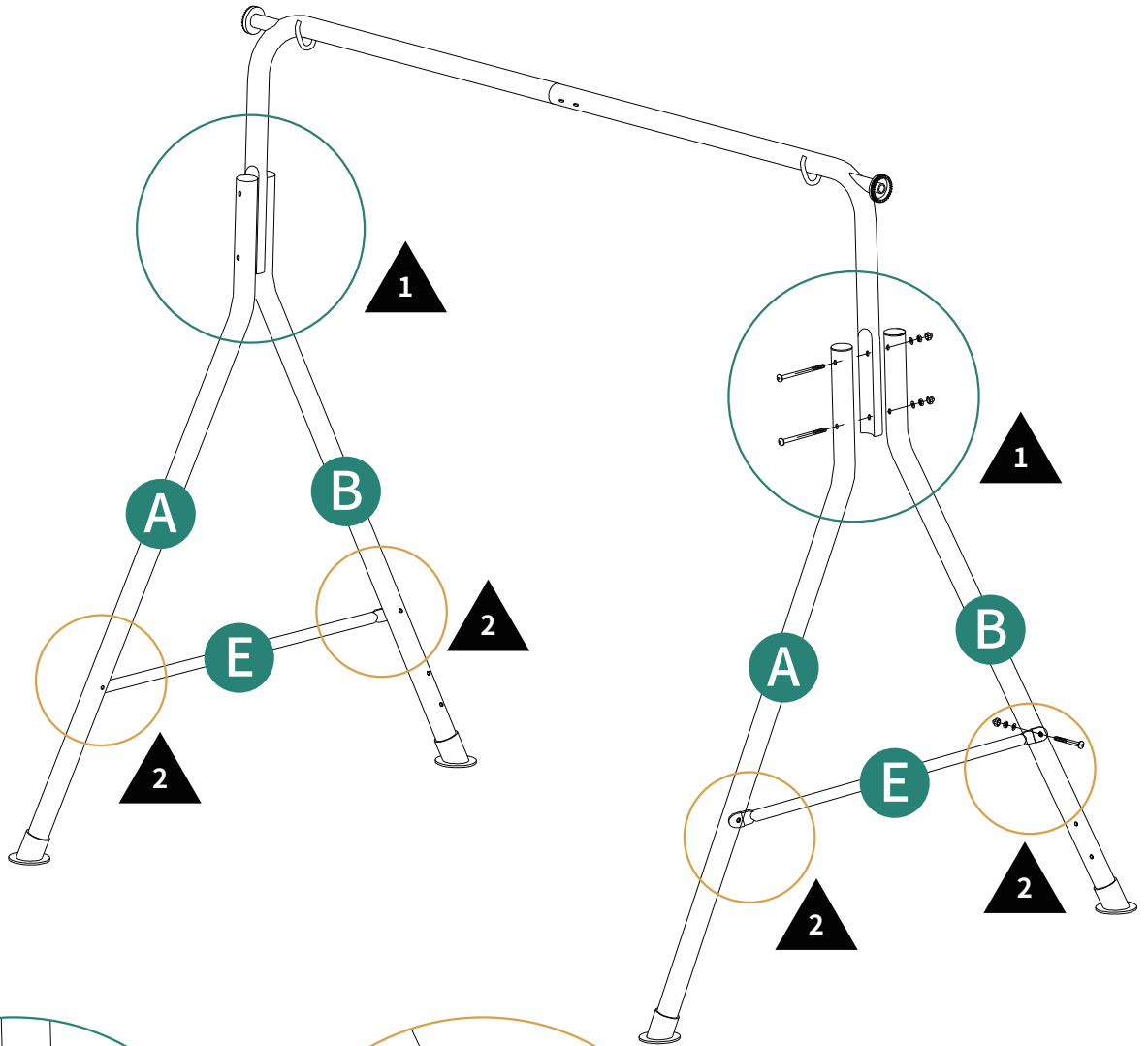
2

- 
- M6 M6 M6
Ⓐ 2pcs Ⓑ 2pcs Ⓔ 2pcs Ⓚ 4pcs Ⓥ 8pcs Ⓦ 8pcs Ⓧ 4pcs Ⓩ 8pcs

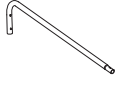
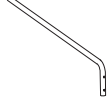

3

- | | | | | | |
|---|---|---|---|--|---|
|  |  |  |  |  |  |
| | | | M6 | M6 | M6 |
| ⓕ1pc | ⓖ1pc | ⓐ1pc | Ⓥ1pc | Ⓦ1pc | Ⓩ1pc |

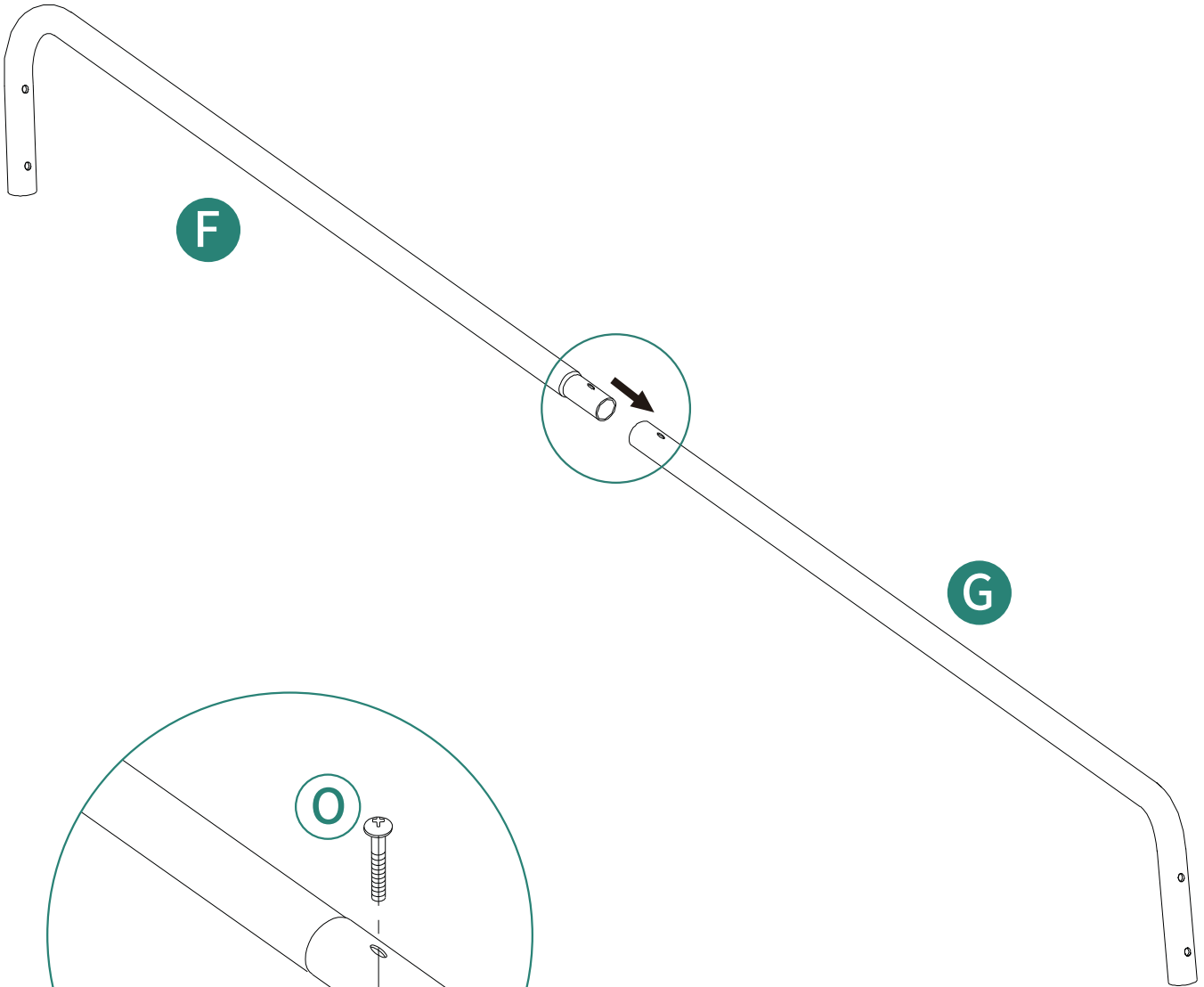

4

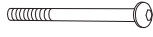

M6

M6

M6

Ⓣ4pcs Ⓥ4pcs Ⓦ4pcs Ⓩ4pcs

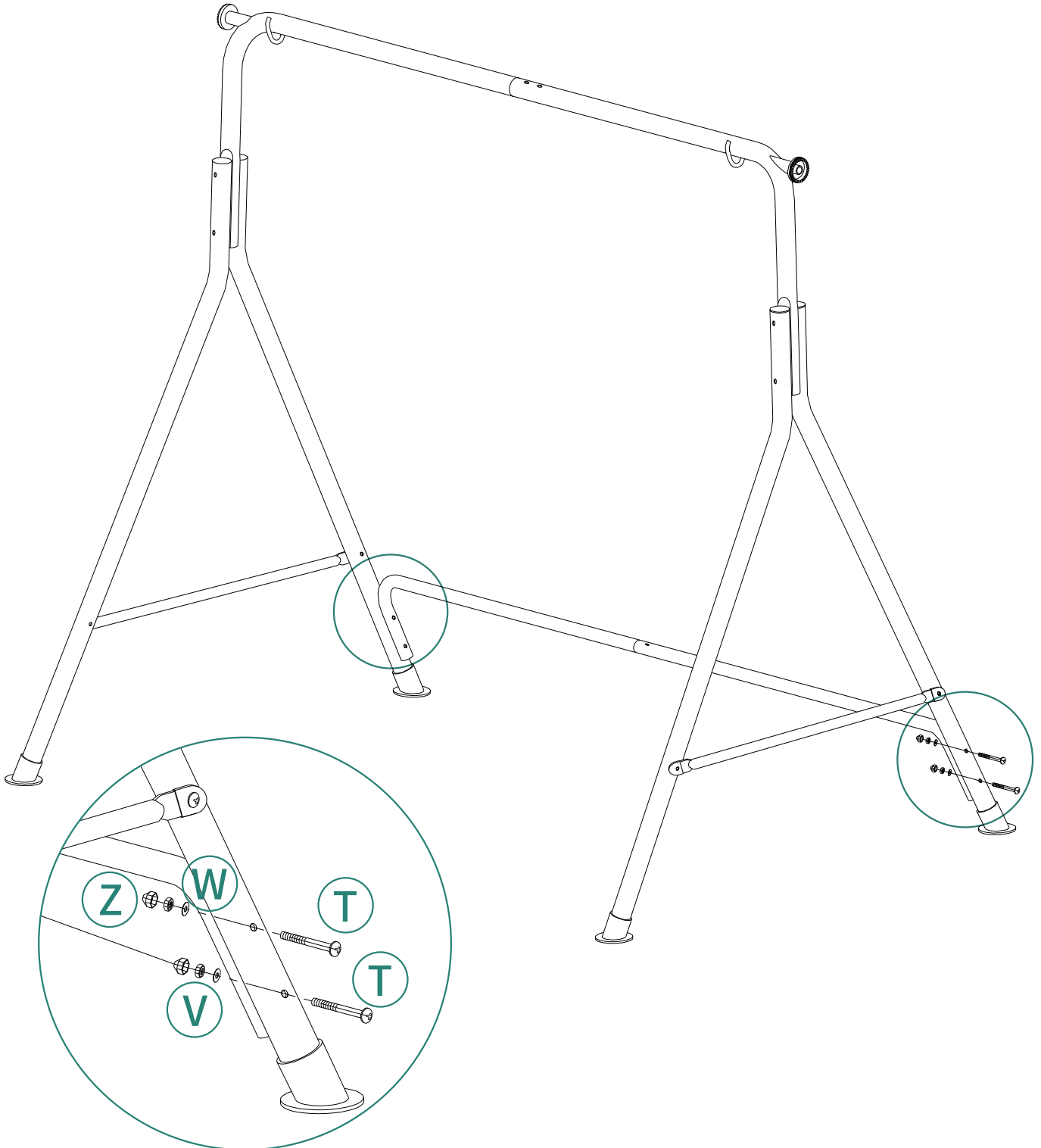

5



ⓐ 2pcs



ⓑ 1pc

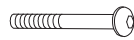

ⓓ 2pcs



M8

ⓔ 2pcs



M8

ⓕ 2pcs



M8

ⓖ 2pcs

1. The back frame is marked by the side edge with a mounting hole in the middle (marked with \triangle), whereas the seat frame is near the outer edge (marked with \circ).
2. The L-shaped armrest's long side should be installed to the back frame, and the short side to the seat frame.
3. Secure the L-shaped armrest's short side to the seat frame first. Leave the long side unfixed until the next step.

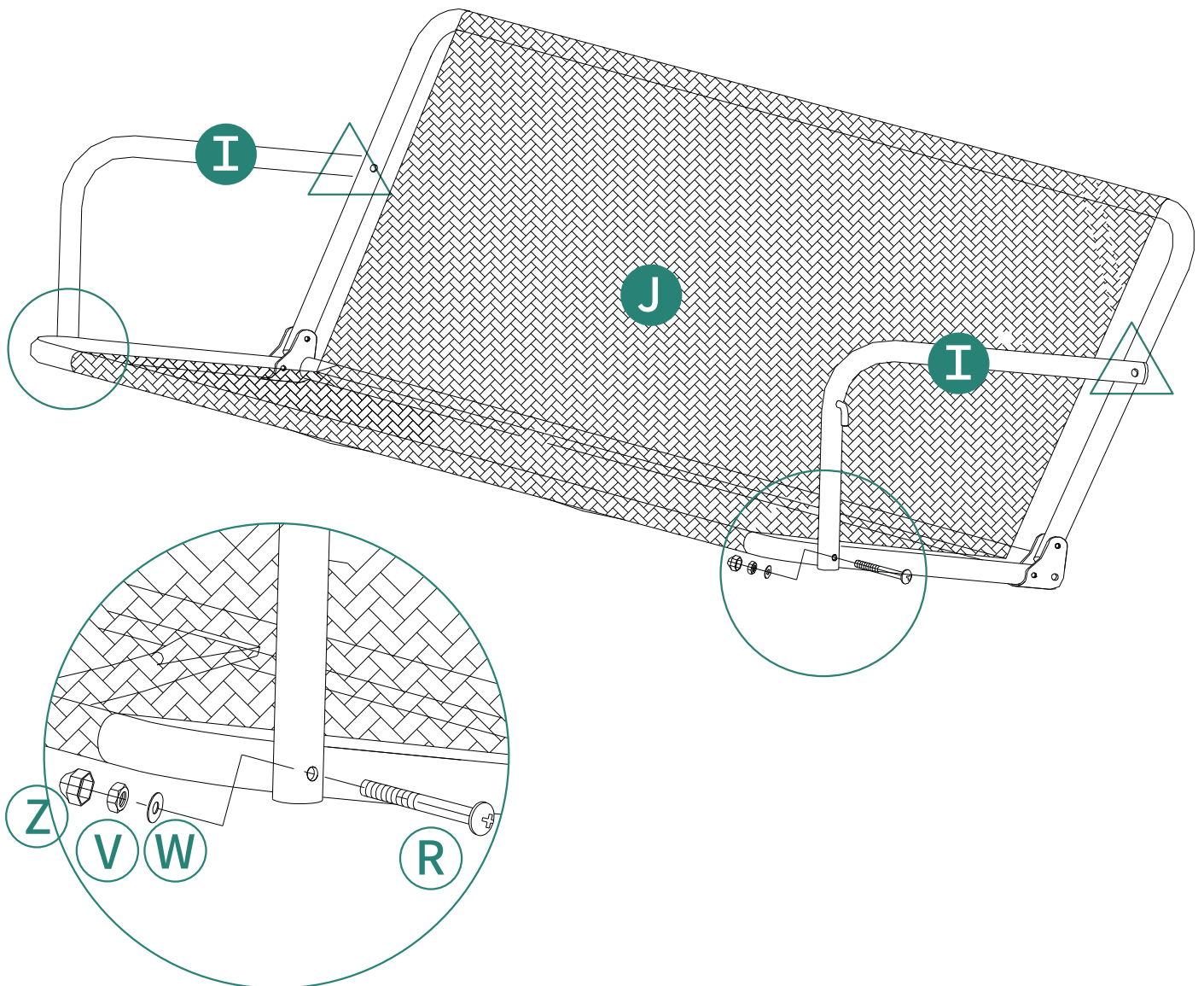

6

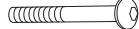

M8

M8

M8

Ⓔ1 4pcs

Ⓘ2 2pcs

Ⓢ2 2pcs

Ⓥ4 pcs

Ⓦ4 pcs

Ⓩ4 pcs

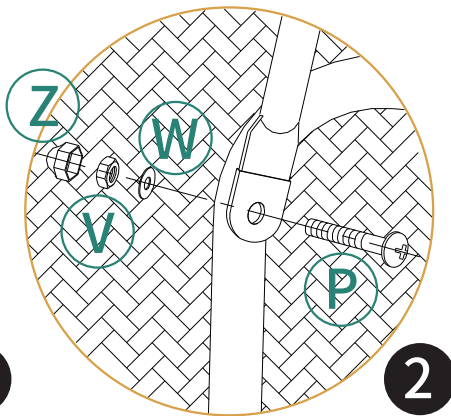
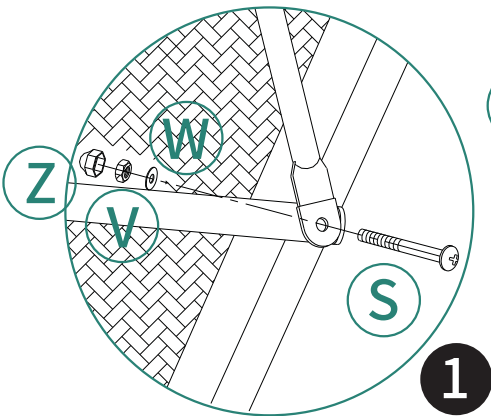
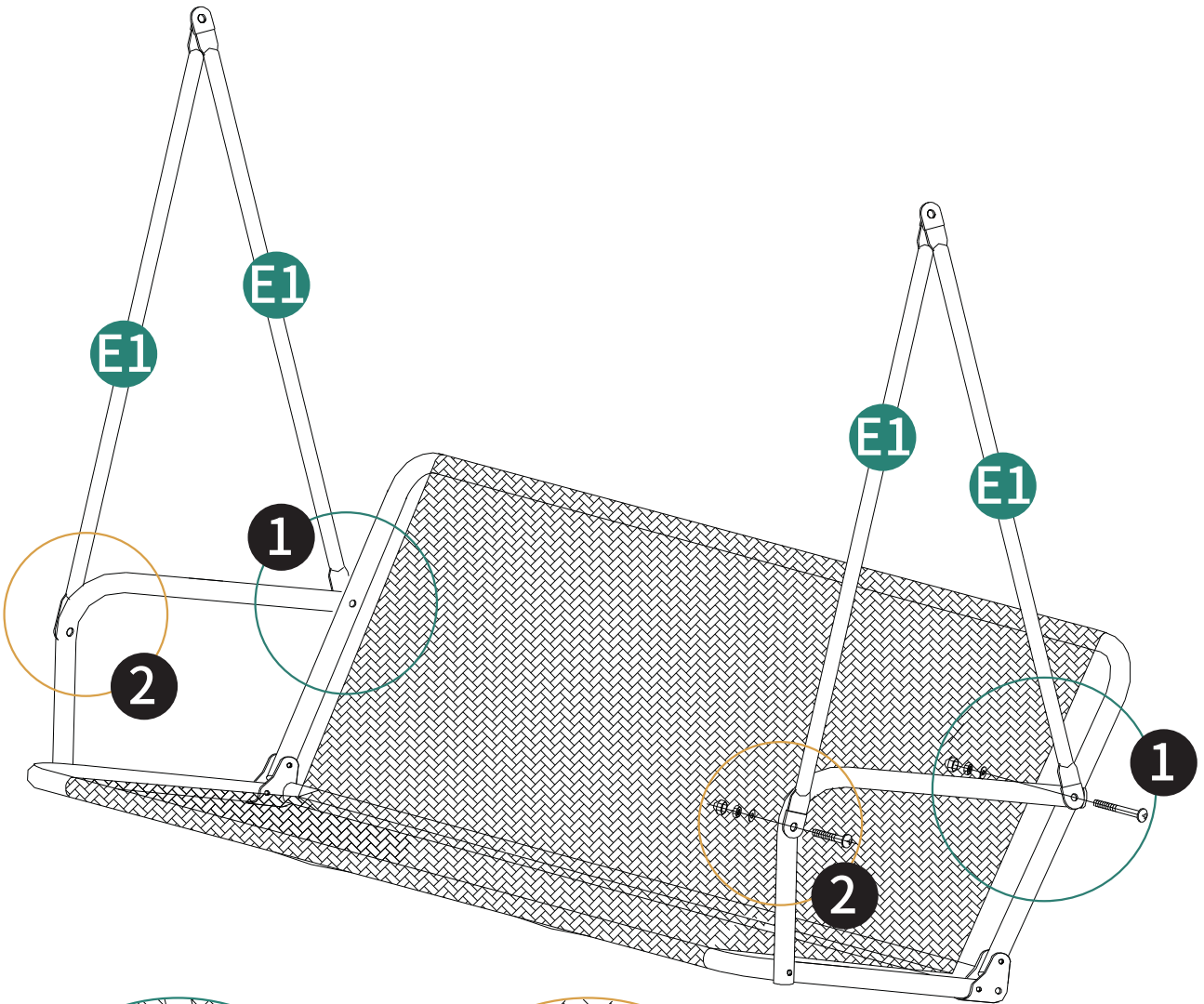

7



H 2pcs

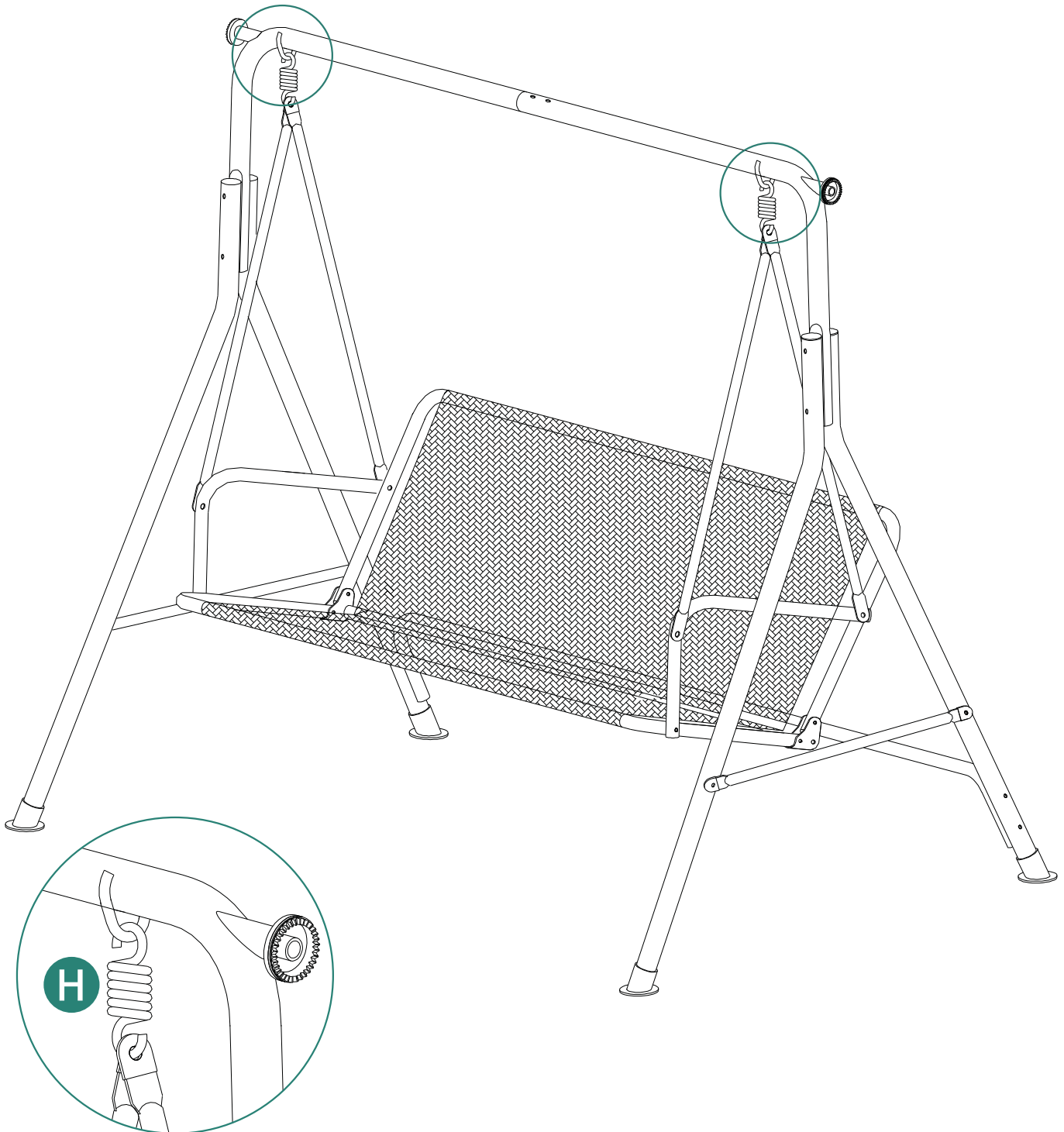

8



Ⓚ2pcs

Ⓨ2pcs

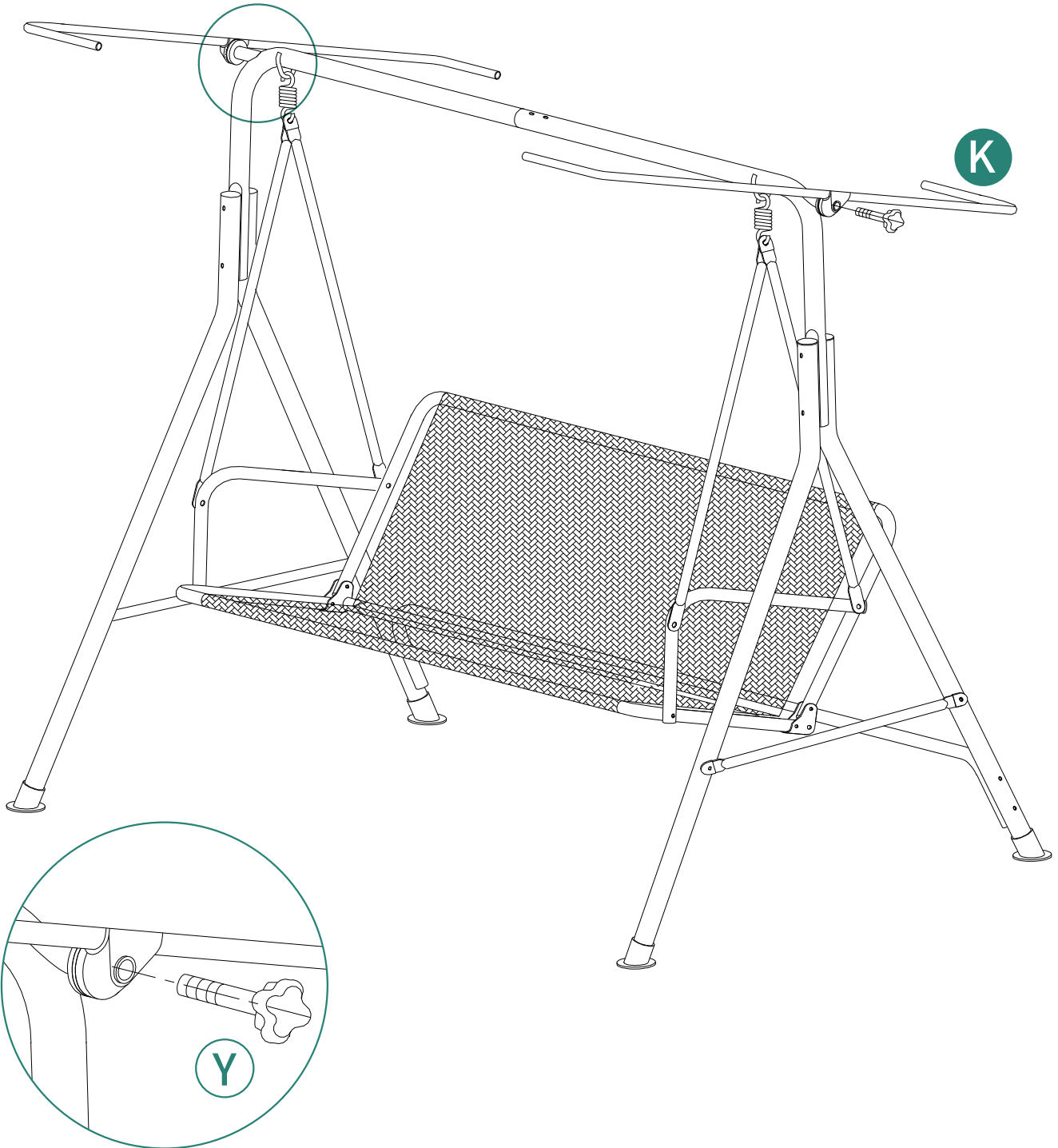

9



Ⓛ2pcs Ⓜ1pc

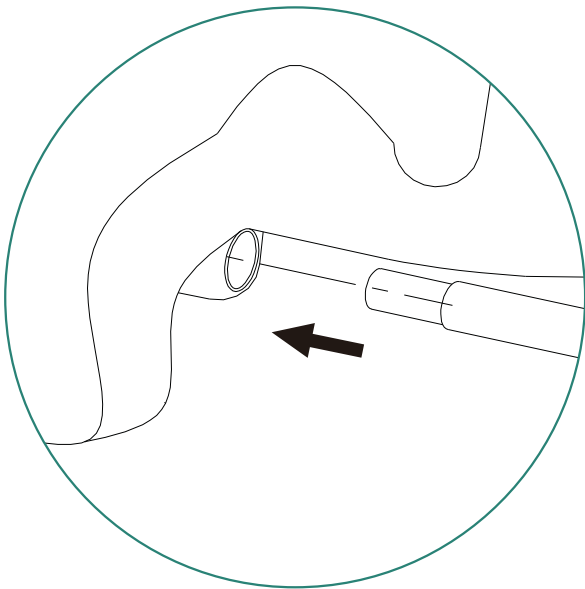
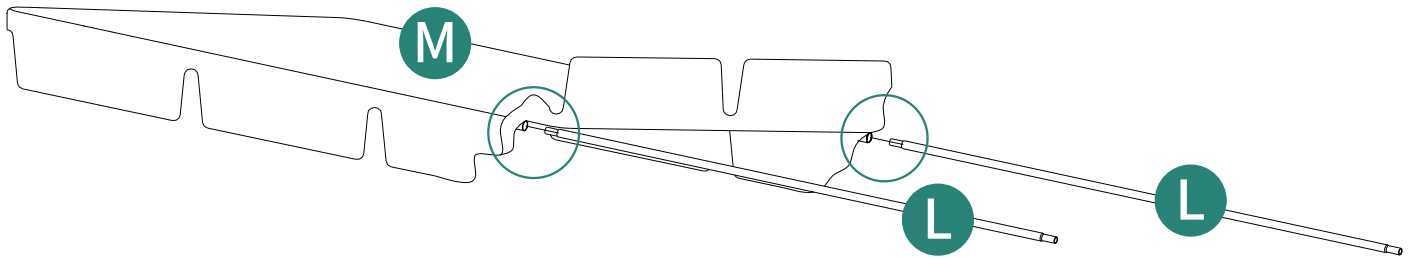

10

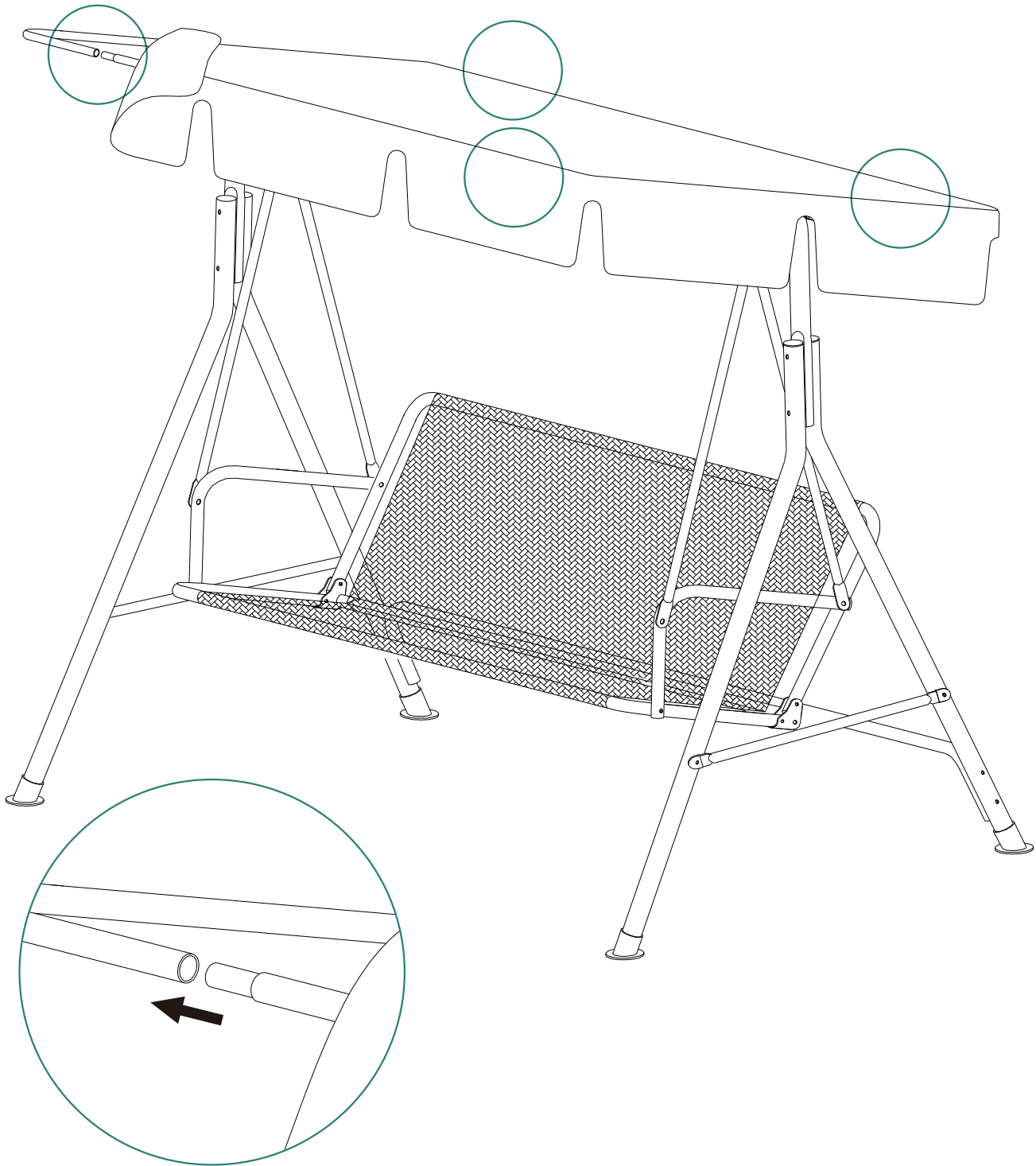

11

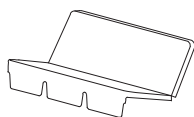

Ⓝ1pc

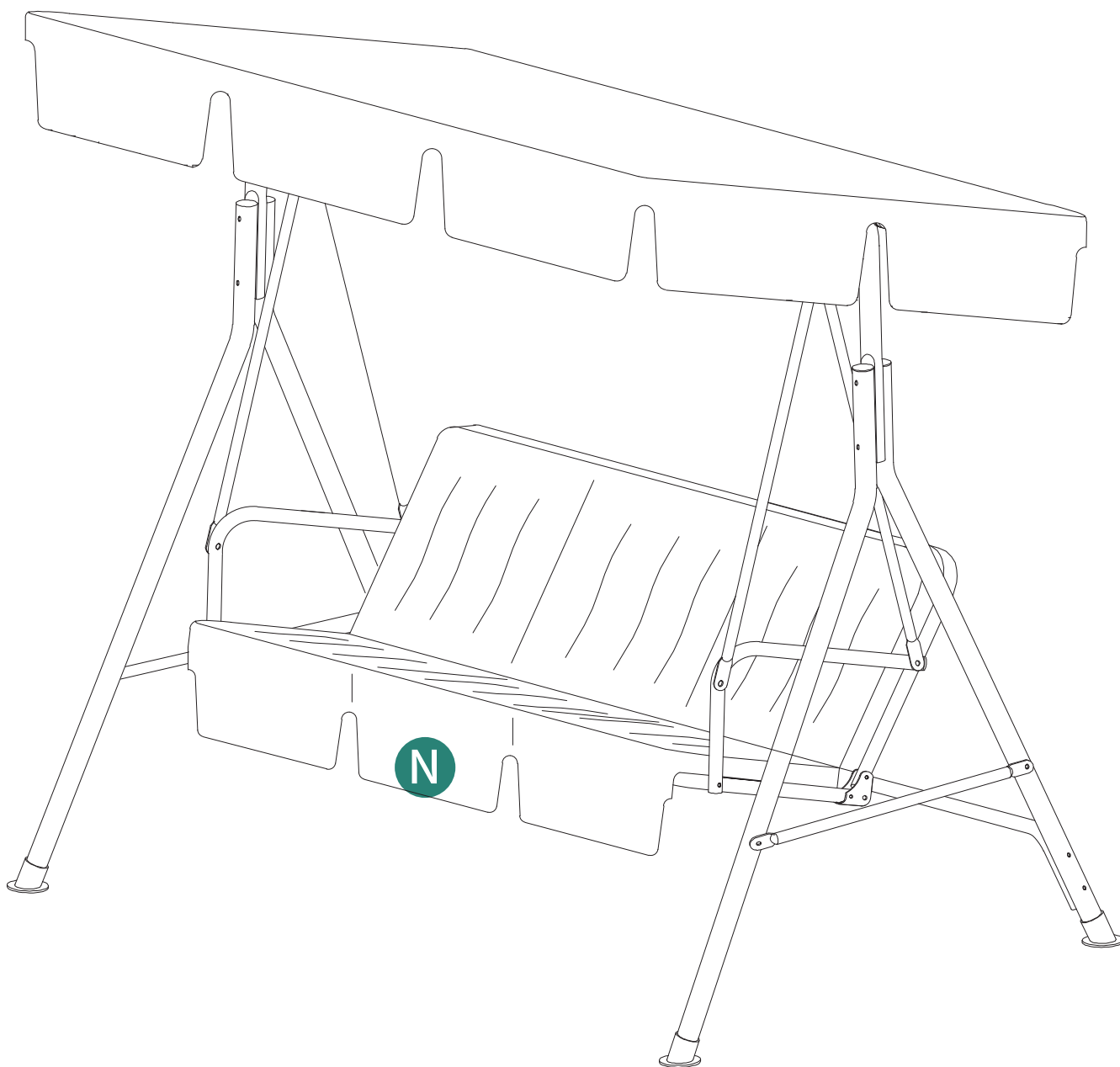

Installation Completed