

OFFICE CHAIR ASSEMBLY INSTRUCTION

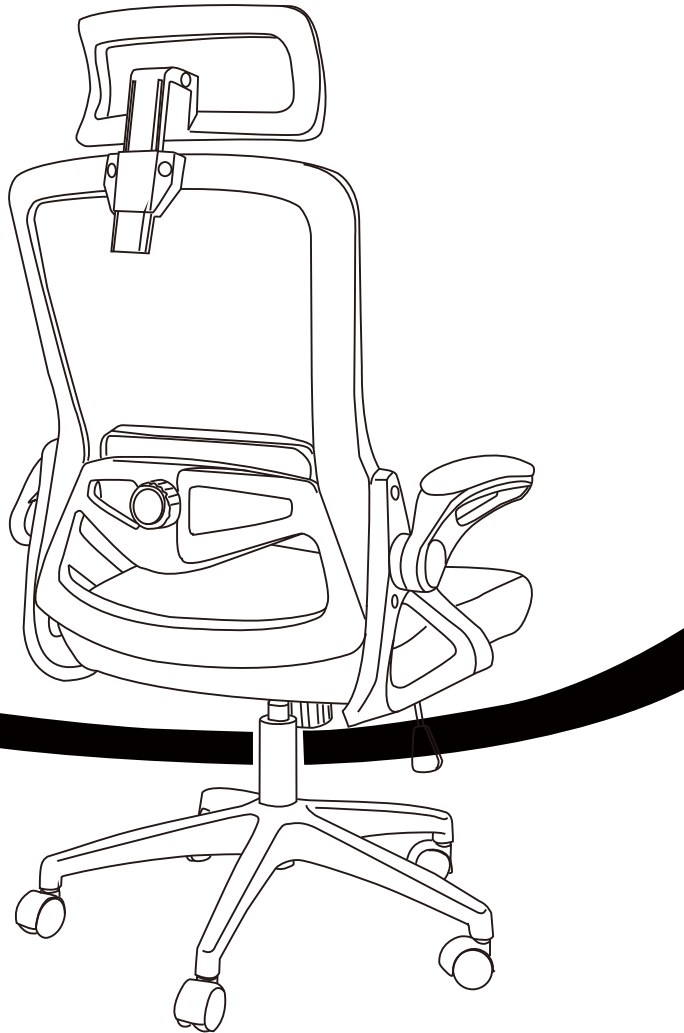

OFFICE CHAIR ASSEMBLY INSTRUCTION

Français	2
Français	15
English	16
English	29
Español	30
Español	43
Italiano	44
Italiano	57
Deutsch	58
Deutsch	71

Bonjour à tous,
Merci d'avoir choisi notre chaise de bureau.



Nos chaises vous donnent accès à un service après-vente.
Si vous avez un problème, merci de contacter l'équipe en ligne
au plus vite, nous vous proposerons une solution sous 24 heures

Vous pouvez nous contacter soit :

Méthode 1 : Contactez-nous sur Amazon

Connectez-vous à votre compte Amazon

"Votre commande" > Trouver votre numéro de commande > cliquer sur "Contacter le Vendeur"

Méthode 2 : Contacter notre équipe en ligne

(E-mail : homechairserviceeu@hotmail.com)

Merci pour votre soutien !

Pièce Endommagée ou Manquante

offrir un Pièce de remplacement

Problème avec la qualité

1. offrir un article de remplacement

OU

2. Remboursement du produit

! IMPORTANT

Suivez les instructions dans le manuel et utilisez un tapis ou
cousin pour éviter d'abimer le produit pendant l'assemblage

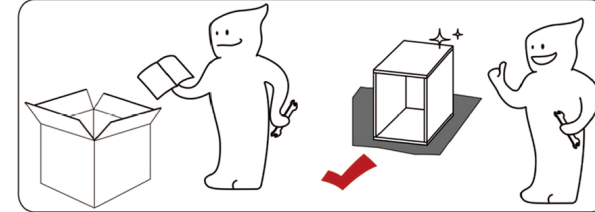
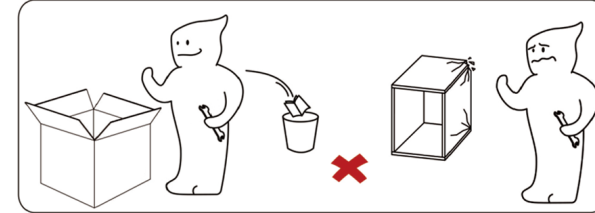

Pour faciliter l'assemblage, il faut au moins 1 adulte.



En moyenne, l'assemblage devrait prendre ½ heure, suivant
les compétences de chaque individu.



Ne doit pas être utilisé par les enfants. Veuillez
surveiller de près vos enfants.



Garder à l'abri du feu et autres sources de chaleur.



N'utiliser pas de produit chimique pour le nettoyage !



L'utilisation de gants est recommandée pour le
montage.













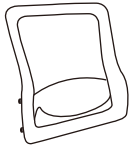

Identifier, trier et compter toutes les pièces avant le
montage

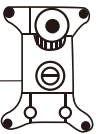

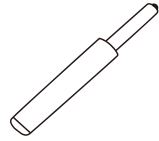
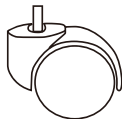

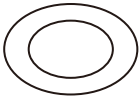

Les avertissements et instructions disponibles dans le manuel peuvent ne
pas couvrir toutes les situations possibles lors de l'utilisation du produit.
Contactez nous sur homechairserviceeu@hotmail.com si vous
avez besoin d'aide.

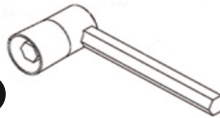
Assurez-vous que toutes les pièces sont dans le paquet.

Sinon, envoyez-nous un e-mail : homechairserviceeu@hotmail.com

			
Dossier - 1pièce	Coussin de siège - 1pièce	Accoudoir Gauche - 1pièce	Accoudoir Droit - 1pièce
			
Plateau - 1pièce	Base - 1pièce	Vérin à gaz - 1pièce	Roue - 5pièces
			
Clé anglaise - 1pièce	Vis (courte) -10pièces	Vis(longue) - 4pièce	Rondelle - 8pièces
			
Appui-tête - 1pièce	Housse - 2pièce	Serrez l'accoudoir (si nécessaire)	

Remarque: Avant l'installation, veuillez classer la vis, mesurer le Longueur de vis pour un assemblage facile (Chaque vis est livrée avec 1 sauvegarde)

ETAPE 1	
	 x1
	 x5

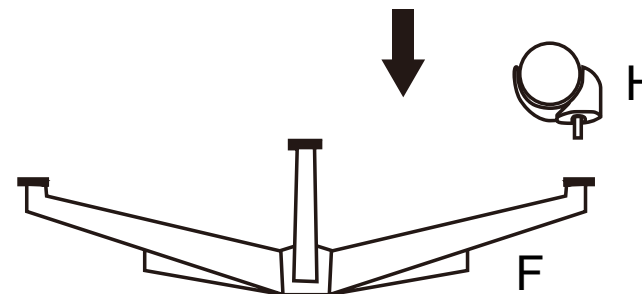
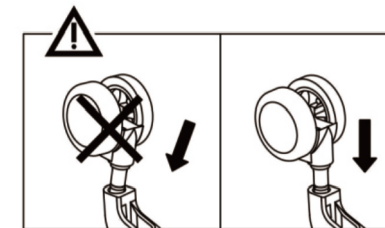

Enfoncer les roues sur la base

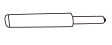
ETAPE 2	
	 x1

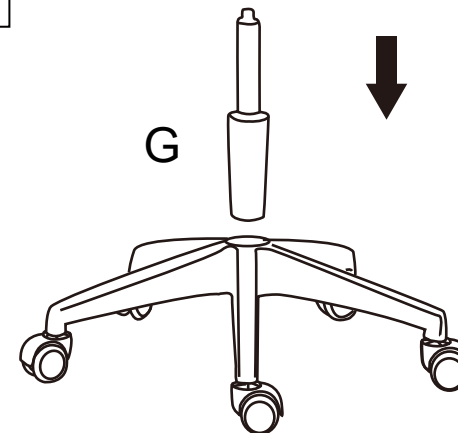



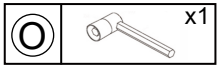

Mettre le vérin sur la base.

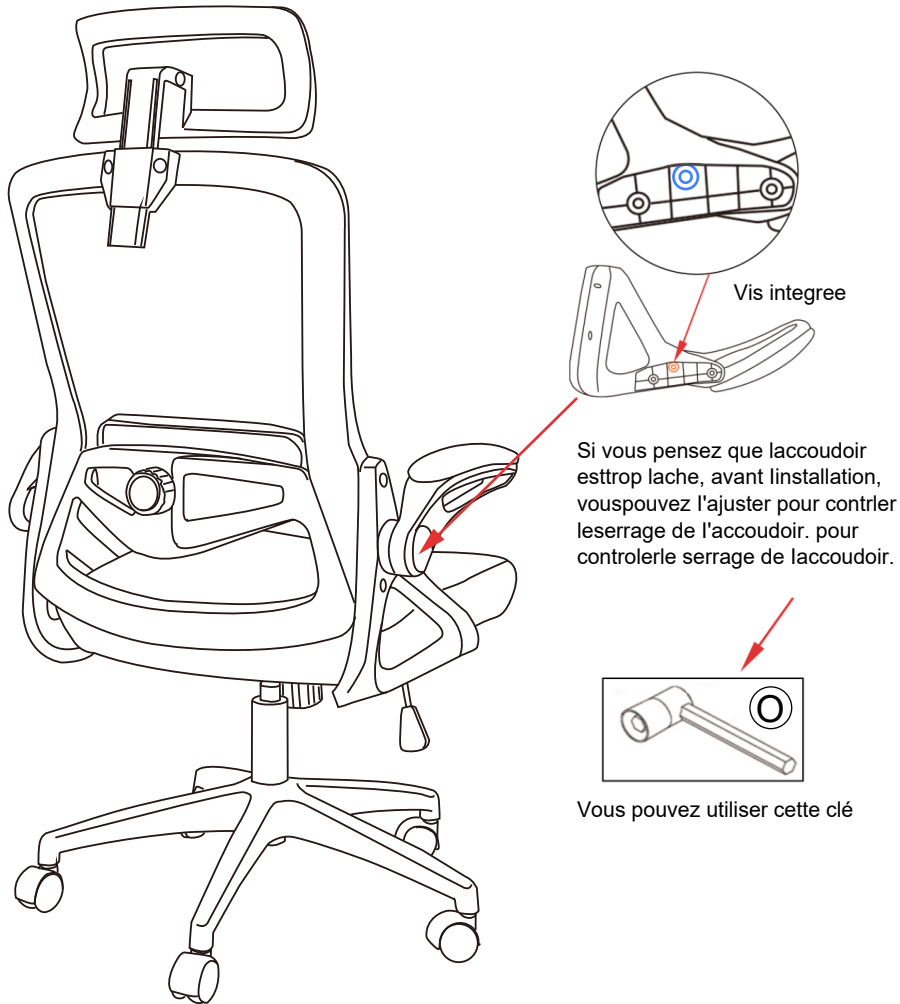

Comment régler l'étanchéité de l'accoudoir ?

! Les accoudoirs sont ajustés à l'étanchéité idéale en usine. Si vous n'en avez pas besoin, sautez-le si vous le souhaitez.



ETAPE 3	
(A)	 x1
(C)	 x1
(D)	 x1
(J)	 x4 Vis courte

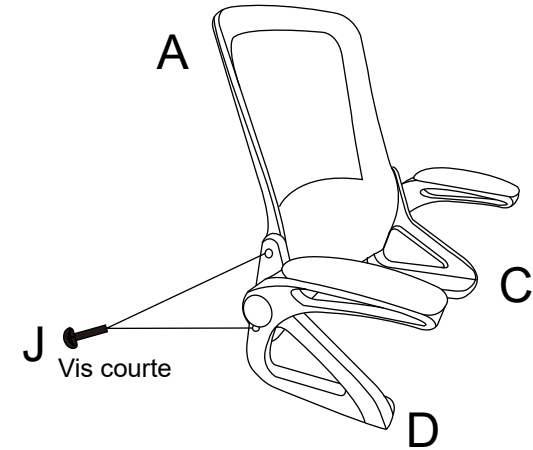

Assembler les accoudoirs et le dossier





NOTA

Remarque: Pendant le montage, veuillez d'abord serrer à moitié toutes les vis dans les trous. Une fois toutes les vis fixées, serrez-les complètement.

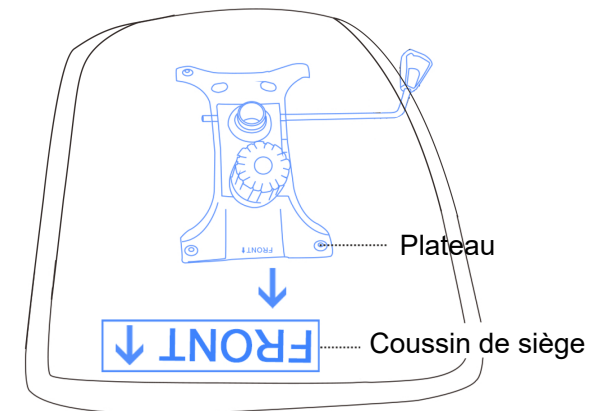
ETAPE 4

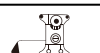

Prenez note de la direction du plateau et du coussin de siège. Suivez la direction indiquée

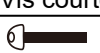
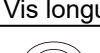
ETAPE 5	
(B)	 x1
(E)	 x1
(J)	 x4 Vis courte
(K)	 x4 Vis longue
(L)	 x8

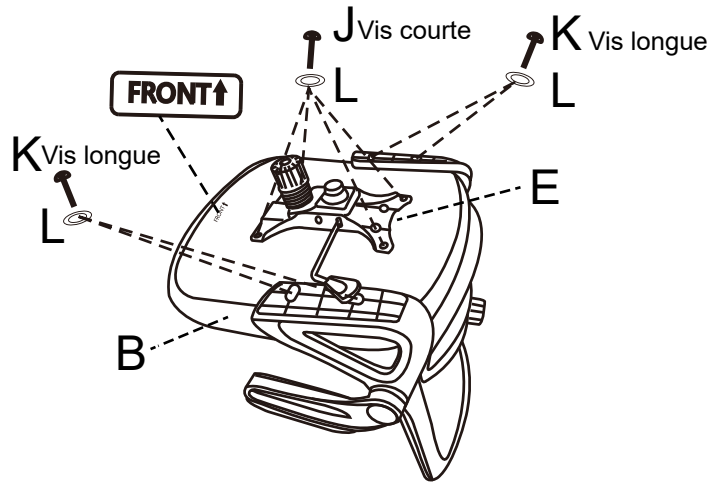

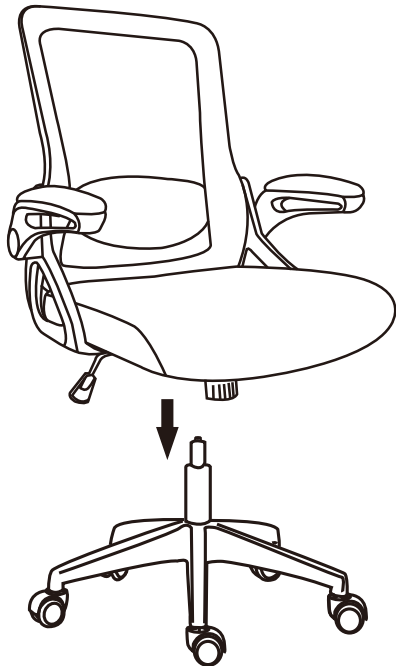

Assembler les accoudoirs et le dossier en premier. Ensuite, attacher le mécanisme sur le coussin de siège. Respecter le sens de l'assemblage!

ETAPE 6

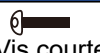
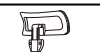

Assembler les deux parties de la chaise

ETAPE 7	
(J)	 x2 Vis courte
(M)	 x1
(N)	 x2

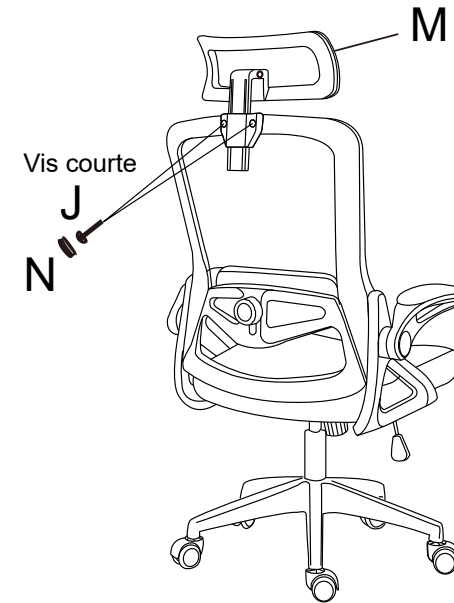

ETAPE 8

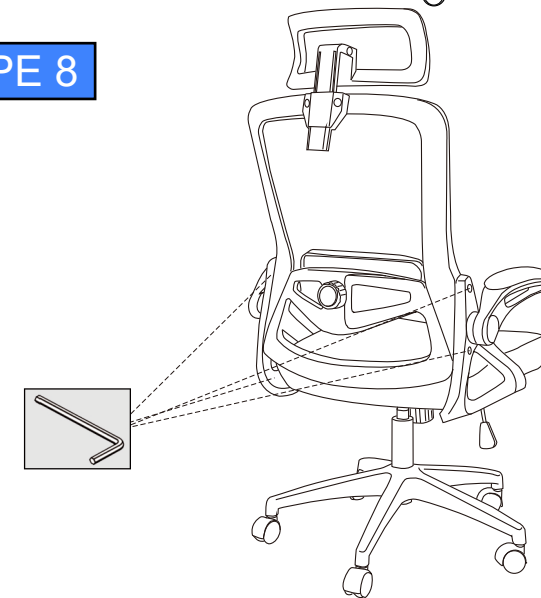

! Pour une meilleure utilisation, une fois que toutes les vis sont en place, serrer encore d'un tour pour que tout soit bien en place

🔧 Méthode d'installation

ETAPE 9

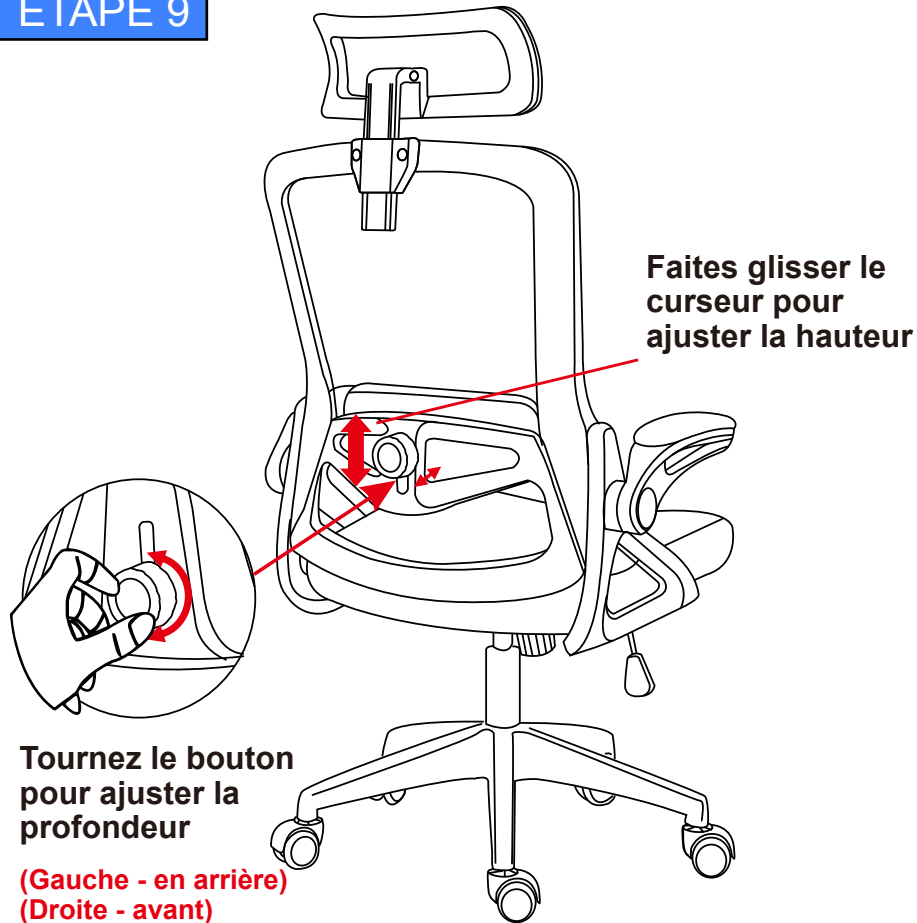

Structure de liaison du support lombaire, S'assurer que le réglage en hauteur du support lombaire se fait en douceur, Veuillez d'abord desserrer légèrement les boutons

Étape 1: Desserrez les boutons

Étape 2: Faites glisser le support lombaire de haut en bas à la bonne hauteur

Étape 3: Tournez le bouton pour ajuster la profondeur appropriée du " soutien lombaire vers l'arrière "

Astuce 1 : Ajustement en hauteur

Utiliser le levier pour ajuster la hauteur : monter ou descendre

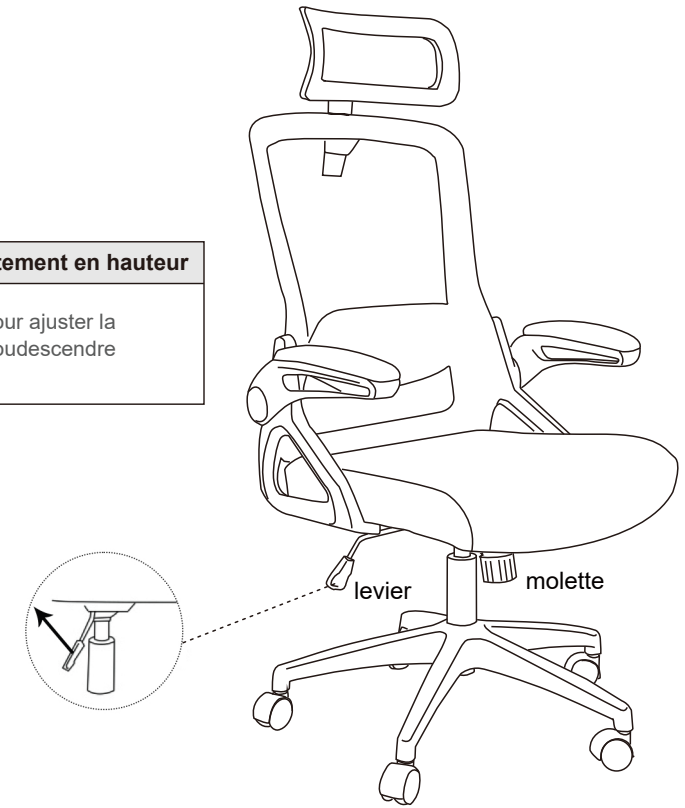

Astuce 2 : Ajustement de l'inclinaison

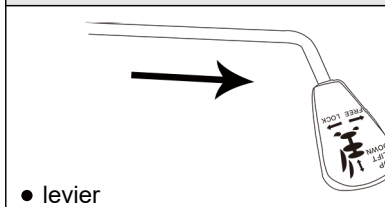

Étape 1
Tirer le levier pour activer le mode bascule

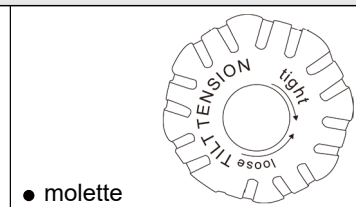

Étape 2
Tourner la molette pour contrôler

Funciones Múltiples

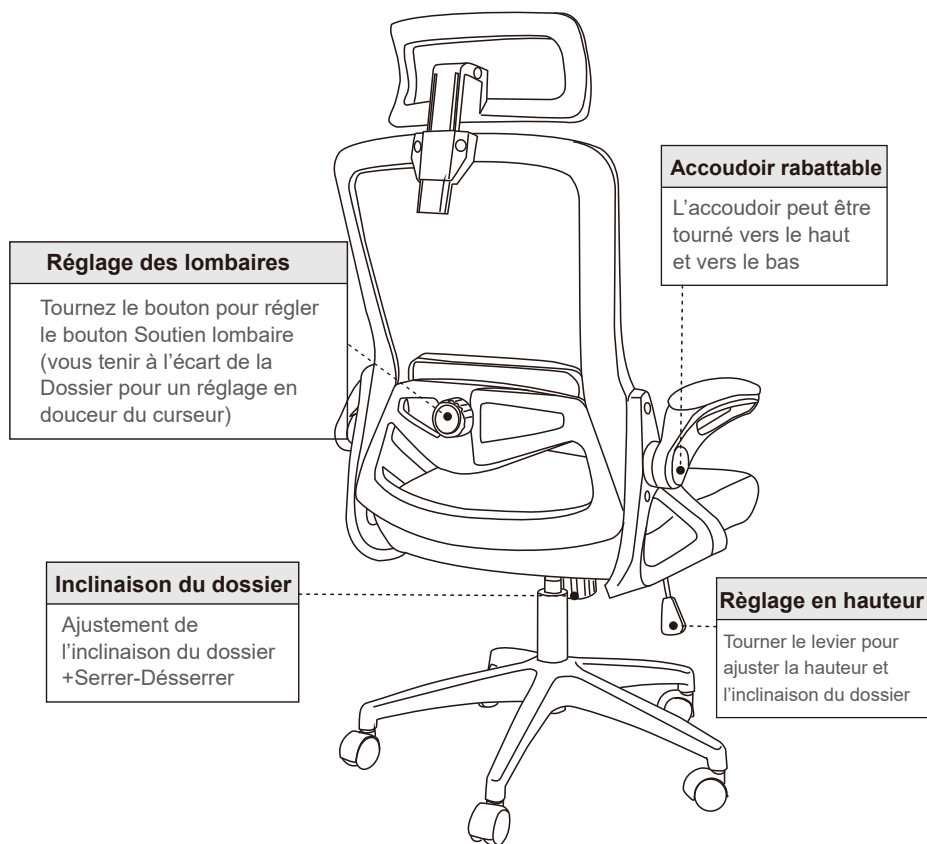

NOTA

Nota: Pour descendre le siège, assurez-vous d'être correctement assis (comme le montre la photo de droite) afin d'avoir assez de force.

Questions/Réponses

Q : Où puis-je obtenir des consignes d'installation ?

R : Vous pouvez également nous contacter si vous avez besoin d'un document d'instructions électronique ou d'une assistance supplémentaire.

Q : Puis-je effectuer l'installation de manière indépendante ?

R : Si vous devez installer le fauteuil de manière individuelle, nous vous recommandons de placer le coussin de siège sur une table ou une chaise plus haute pour faciliter votre installation. Veuillez-vous référer à nos instructions.

Q : Comment régler le support lombaire ?

R : La hauteur du support lombaire peut être réglée en poussant le curseur en plastique vers le haut et vers le bas. (Veuillez garder votre dos éloigné du dossier pour un réglage en douceur.)

Q : Comment ajuster si le fauteuil est incliné vers l'avant ?

R : Cela peut être dû à une mauvaise orientation du plateau et du coussin de siège. Veuillez maintenir le plateau et le coussin de siège dans la même direction que celle indiquée.

Q : Si les vis ne sont pas alignées avec les trous pendant l'installation, comment puis-je les ajuster ?

R : Vous pouvez d'abord placer les vis dans les trous correspondants, puis les serrer à moitié. Puis serrer complètement toutes les vis une fois qu'elles sont en place.

Q : Que dois-je faire s'il manque certains éléments dans le colis ?

R : N'hésitez pas à nous contacter pour une aide rapide s'il manque des pièces dans l'emballage.

Q : Que dois-je faire si mon colis est endommagé ?

R : Le transport longue distance peut endommager le colis. N'hésitez pas à nous contacter pour obtenir une aide rapide.

Merci pour votre soutien !

Si vous avez besoin d'aide supplémentaire, n'hésitez pas à contacter notre service client pour une aide rapide nous ferons de notre mieux pour vous aider.

ATTENTIONS

1. Utilisez ce produit uniquement pour asseoir une personne à la fois

2. Ne vous mettez pas debout sur la chaise et ne l'utilisez pas comme escabeau ou échelle

3. N'utilisez pas la chaise si tous les boulons, vis et leviers ne sont pas serrés

4. Ne pas placer le produit près du feu ou d'une source de chaleur !

5. Ne pas utiliser de nettoyeurs corrosifs pour le nettoyage !

Ce produit n'est pas un jeu d'escalade pour les enfants, car ils pourraient se blesser. Veuillez ne pas laisser les enfants sans surveillance

S'il y a un problème, n'hésitez pas à nous contacter

E-mail: homechairserviceeu@hotmail.com

Hello Friend,
Thanks for choosing our office chair.



Our chair comes with product warranty service.

If you have any issues, please contact our online service team immediately, will provide you with a satisfactory solution within 24 hours.

Please feel free to contact us via the following path:

Path 1: Contact us via Amazon

Login your Amazon Account

"Your Order" > find the order ID > click "Contact Seller"

Path 2: Contact our online service team

(E-mail : homechairserviceeu@hotmail.com)

Thanks again for your support and understanding!

Damaged or Missing Component

Promptly re-send component from amazon

Quality Problem

1. Promptly re-send product from amazon
- OR**
2. Order Refund

! IMPORTANT

Please follow the instruction manuals and use a pad to avoid damage during assembly.

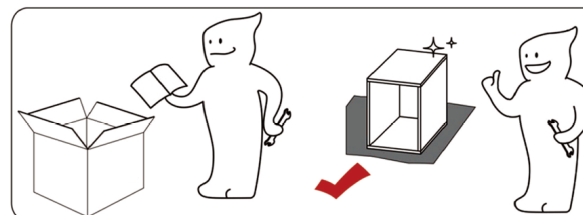
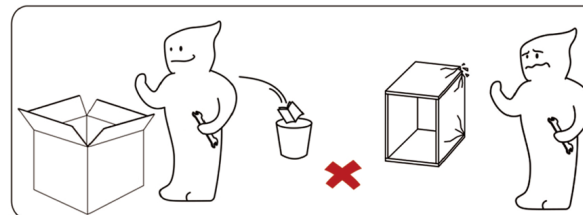

For easier and better assembly, 1 or more adults are required.



The expected assembly time for this product is 0.5 h, depending on the individual's manipulative ability.



Not intended for use by children. Please keep your children closely supervised.



Keep away from fire or other heat sources.



Do not use harsh cleaner for cleaning!



We recommend wearing protective gloves for assembly.













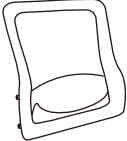

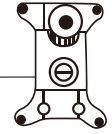

Identify, sort and count the parts before assembly.

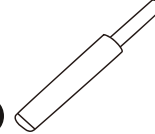

The warning, cautions and instructions listed in this manual may not cover all possible situations that may arise when using the product. Please contact us via homechairserviceeu@hotmail.com if you need further help.

Please Make sure all parts are included.

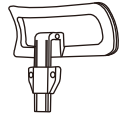
If not email us homechairserviceeu@hotmail.com

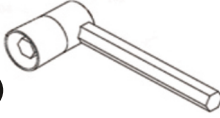
			
Backrest - 1pcs	Seat Cushion - 1pcs	Left Armrest - 1pcs	Right Armrest - 1pcs
			
Tray - 1pcs	Base - 1pcs	Gas Lift - 1pcs	wheel - 5pcs
	 x10 Short Screw (M6*22mm)	 x4 Long Screw (M6*35mm)	
Allen Key - 1pcs	Short Screw - 10pcs	Long Screw - 4pcs	Washer - 8pcs
			
Headrest - 1pcs	Cover - 2pcs	Socket Wrench - 1pcs	

**Notice: Before installation, please classify the screw, measure the screw length for easy assemble
(Each screw comes with 1 backup)**

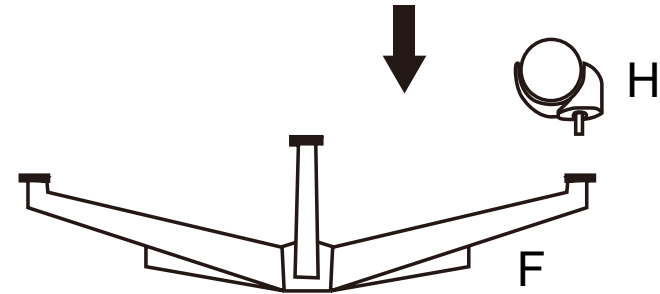
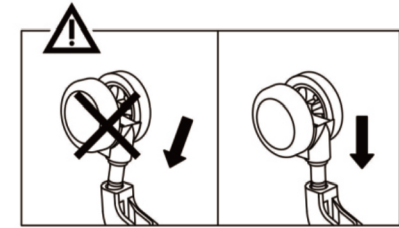
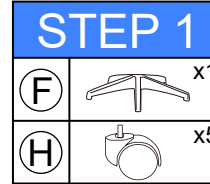

Push the wheels to the base.

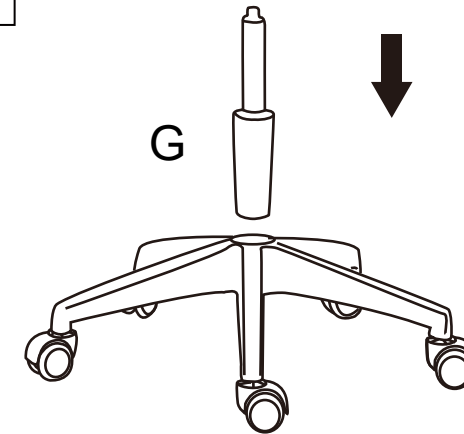

Put the gas lift on the base.

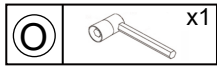

How to adjust the tightness of the armrest?

! The armrests are adjusted to the ideal tightness at the factory.
If you don't need it, skip it please.

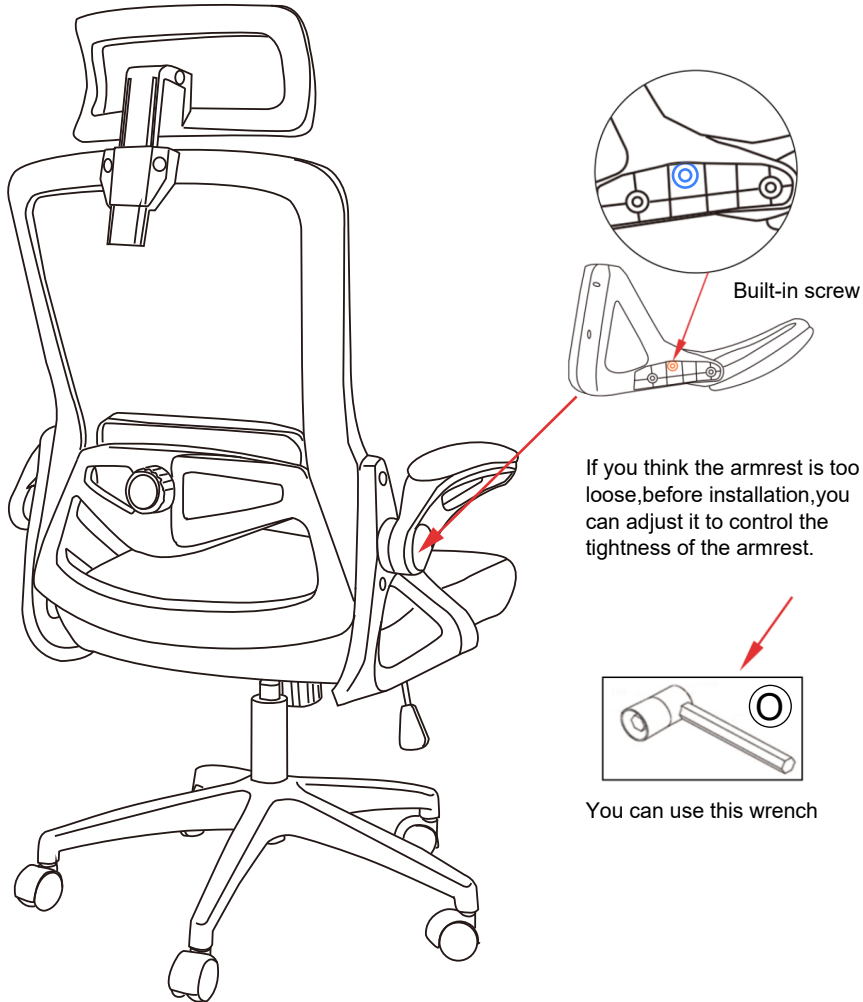

STEP 3		
(A)		x1
(C)		x1
(D)		x1
(J)		x4 short screw

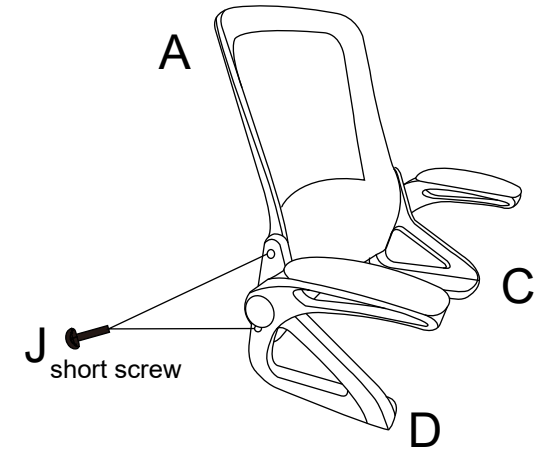

Assemble the armrest and back firstly.



NOTE



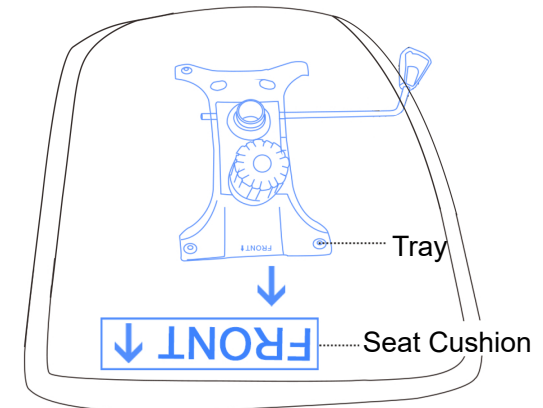

Note: During the assembly, please first half-tighten all the screws into the holes. After all the screws are set, fully tighten them.

STEP 4



Please notice the direction of the tray and the seat cushion.
Keep the same direction as indicated.

STEP 5

(B)		x1
(E)		x1
(J)		x4 short screw
(K)		x4 long screw
(L)		x8

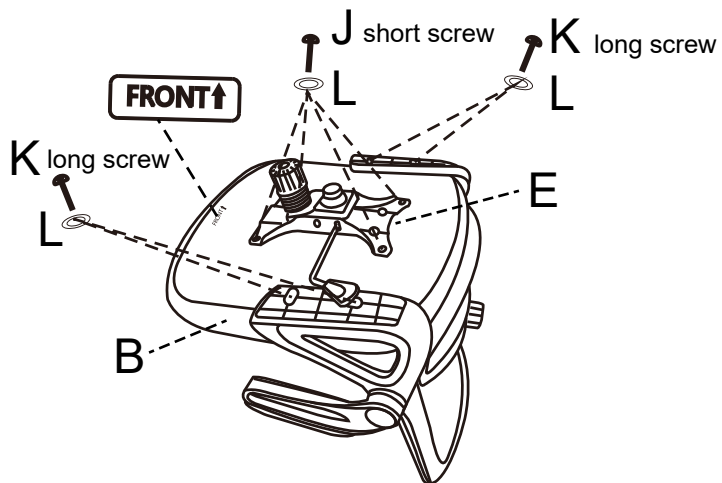

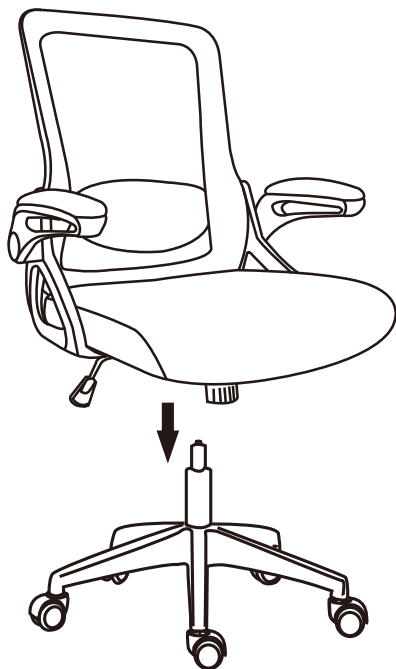

Assemble the armrest and seat cushion first.
After that attach the mechanism on the seat cushion.
Please notice the direction!

STEP 6



Assemble the chair with two whole parts

STEP 7

(J)		x2 short screw
(M)		x1
(N)		x2

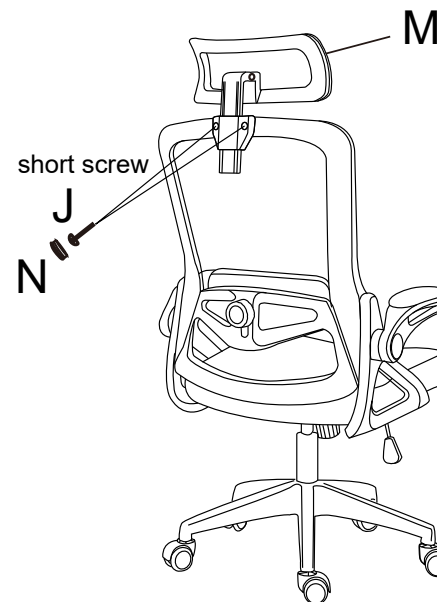

STEP 8

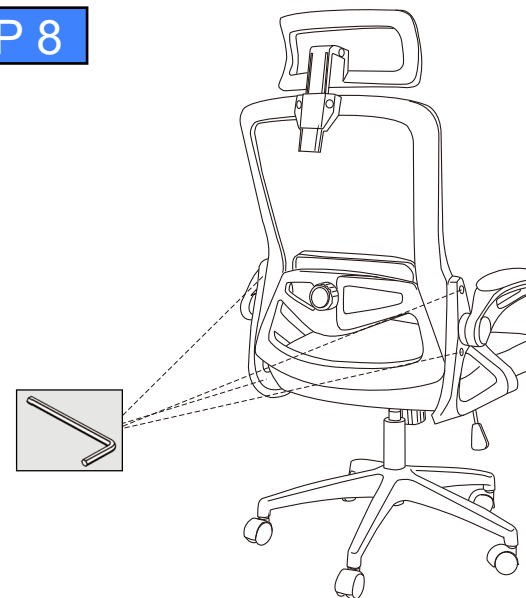

For better using experience, After all the screws are set, please twist one more time to fully tighten them

STEP 9

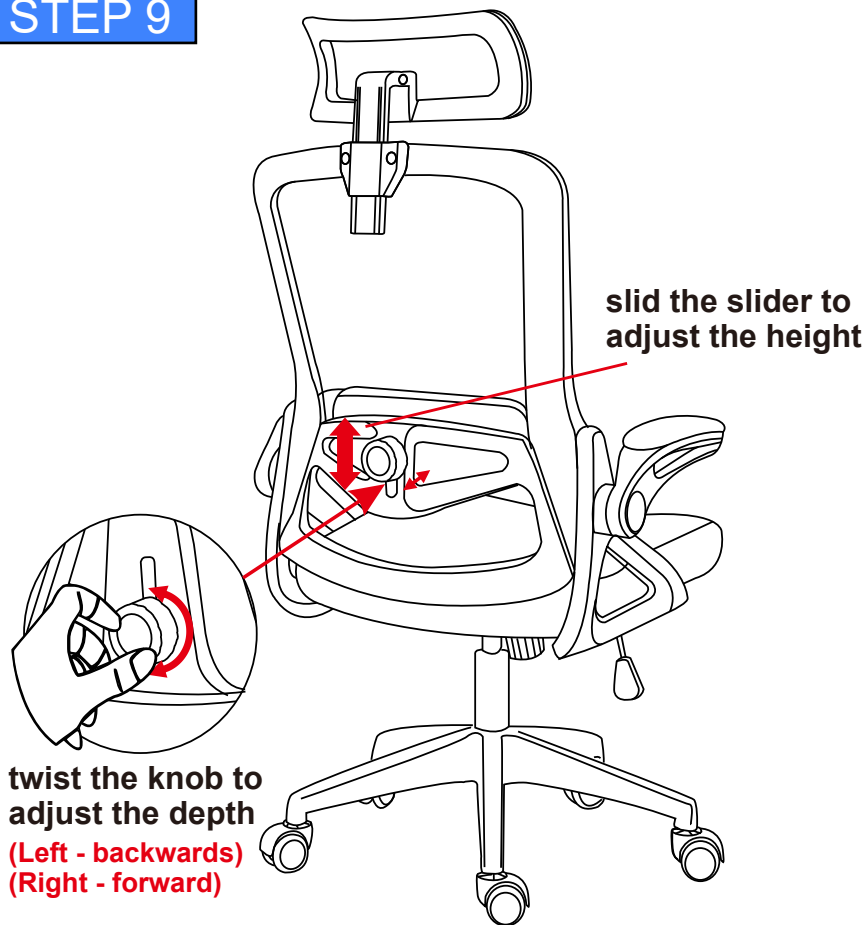

Linkage Structure Lumbar Support
 Ensure height adjustment of lumbar support is smooth, please first loosen the knobs slightly

- Step 1: Loosen the knobs
- Step 2: Slide the lumbar support up and down to the correct height
- Step 3: Twist the knob to adjust the suitable depth of the "lumbar support-to-back"

Setup Method

Tips 1: Height Adjustment

press the lever to adjust the seat height up and down

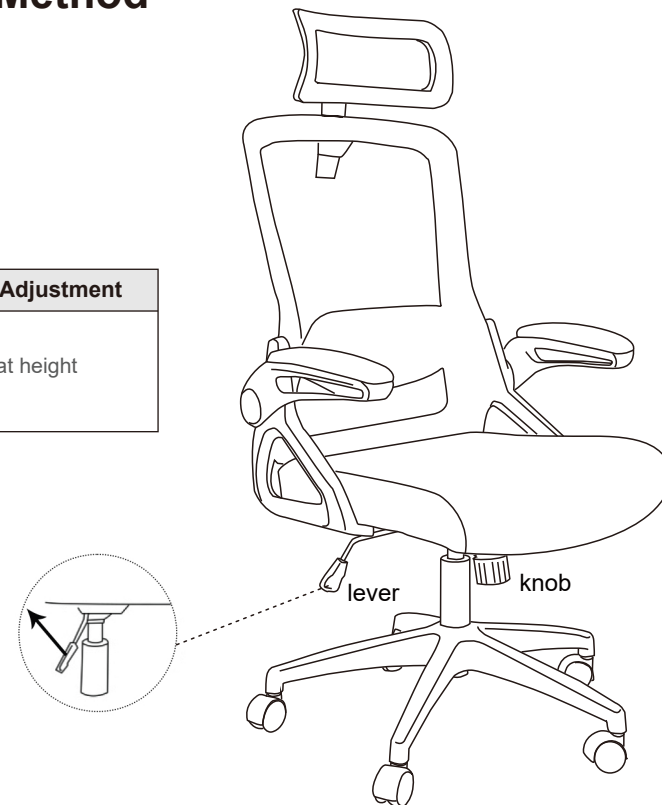

Tips 2: Tilt Tension Adjustment

<ul style="list-style-type: none"> ● lever 	<ul style="list-style-type: none"> ● knob
<p>Step 1 pull out the lever to active the rocking mode</p>	<p>Step2 twist the knob to control the tilt tension</p>

Multiple Functions

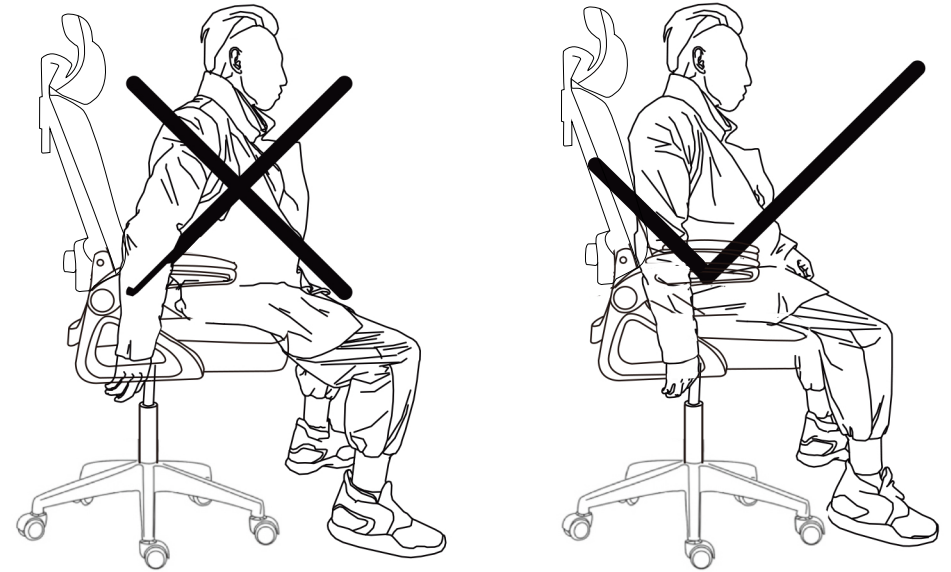
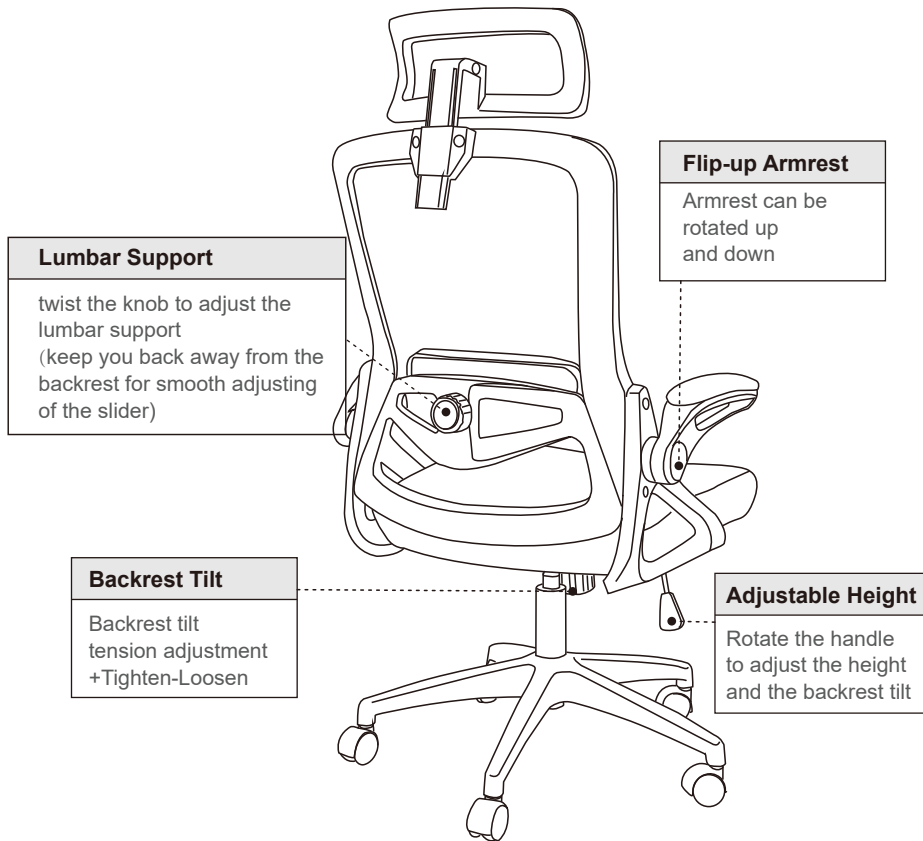

! NOTE

Note: When lowering down the seat height, please make sure to fully sit on the seat (as the right figure shows below) in order to give it enough pressure.

Q&A

Q: Where can I get installation instructions?

A: You can also contact us if you need an electronic instruction document or further assistance.

Q: Can I complete the installation independently?

A: if you need to install the chair independently, we recommend that you put the seat cushion on a higher table or chair to assist your installation. please refer to our instructions.

Q: How to adjust if the chair is tilted forward?

A: It may be due to the wrong orientation of the tray and the seat cushion, please keep the tray and the seat cushion in the same direction as indicated.

Q: If the screws are not aligned with the holes during installation, how can I adjust them?

A: You can put the screws into the corresponding holes first, and tighten them halfway.
And then fully tighten all the screws after a the screws are set.

Q: What should I do if the package lacks some components?

A: Please feel free to contact us for prompt help if the package lacks some components.

Q: What should I do if my package were damaged?

A: Long-distance transit may cause damage to the item under special circumstances, please feel free to contact us for prompt help.

Thanks for your support!

If you need further assistance, please feel free to contact our customer service team for prompt help, we will do our best to help you.

ATTENTIONS

1. Use this product only for seating one person at a time
2. Do not stand on the chair use as a step stool or ladder
3. Do not use the chair unless all bolts, screws and knobs are tighten
4. Do not place the product near the fire or heat source !
5. Do not use corrosive cleaners for cleaning !
6. This product is not a climbing frame for children's play, which could result in injury. Please do not leave children unattended

If there is any problem, do not hesitate to contact us with
E-mail : homechairserviceeu@hotmail.com

Hola amigo,
Gracias por elegir nuestra silla de oficina.



Nuestra silla cuenta con un servicio de garantía para el producto. Si tienes algún problema, ponte en contacto con nuestro equipo de atención online de inmediato, te proporcionará una solución satisfactoria en 24 horas.

No dudes en ponerte en contacto con nosotros a través de las siguientes formas:

Forma 1: Contacta con nosotros a través de Amazon

"Tus Pedidos" > busca el ID del pedido > haz clic en "Contactar con el Vendedor"

Forma 2: Contacta con nuestro equipo de atención online

(E-mail: homechairserviceeu@hotmail.com)

¡Gracias de nuevo por tu apoyo y comprensión!

Componente Dañado o que Falta

Reenviar rápidamente el componente desde Amazon

Problema de Calidad

1. Reenviar rápidamente el producto desde Amazon
-
2. Reembolso del pedido

! IMPORTANTE

Por favor, sigue el manual de instrucciones y utiliza un protector para evitar daños durante el montaje.

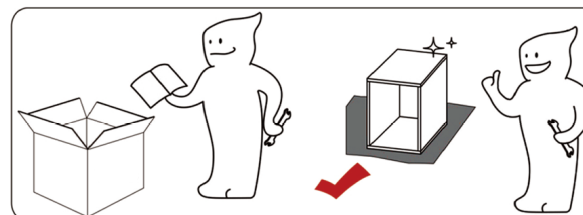
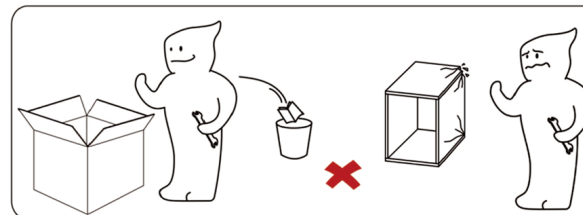

Para facilitar y mejorar el montaje, se necesitan 1 o más adultos <VV.



El tiempo de montaje previsto para este producto es de 0,5 h, dependiendo de la destreza de la persona que lo manipule.



No está pensado para que lo utilicen los niños. Por favor, mantén a tus hijos bajo estrecha supervisión.



Mantener alejado del fuego o de otras fuentes de calor



No utilices limpiadores agresivos para su limpieza!



Recomendamos usar guantes de protección para el montaje.













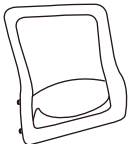

Identifica, clasifica y cuenta las piezas antes del montaje.

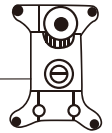

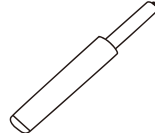
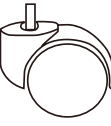
Es posible que las advertencias, precauciones e instrucciones que figuran en este manual no contemplen todas las posibles situaciones que puedan surgir al utilizar el producto. Ponte en contacto con nosotros en **homechairserviceeu@hotmail.com** si necesitas más ayuda.



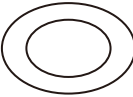
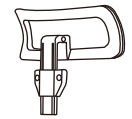

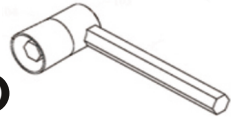
Por favor, asegúrese de que todas las piezas están incluidas.

Si no es así envíenos un correo electrónico homechairserviceeu@hotmail.com

			
Respaldo - 1 pieza	Cojín de asiento 1 pieza	Apoyabrazos izquierdo - 1 pieza	Apoyabrazos derecho - 1 pieza
			
Bandeja - 1 pieza	Base - 1 pieza	Elevador de gas 1 pieza	rueda - 5piezas
	 x10 Tornillo corto (M6*22mm)	 x4 Tornillo largo (M6*35mm)	
Llave Allen - 1 pieza	Tornillo corto - 10 piezas	Tornillo largo - 4 piezas	Arandela - 8 piezas
			
Reposacabezas - 1 pieza	Tapa - 2 piezas	Llave de vaso - 1 pieza	

Aviso: Antes de la instalación, por favor clasificar el tornillo, medir la longitud del tornillo para facilitar el montaje
(Cada tornillo viene con 1 copia de seguridad)

PASO 1

	 x1
	 x5

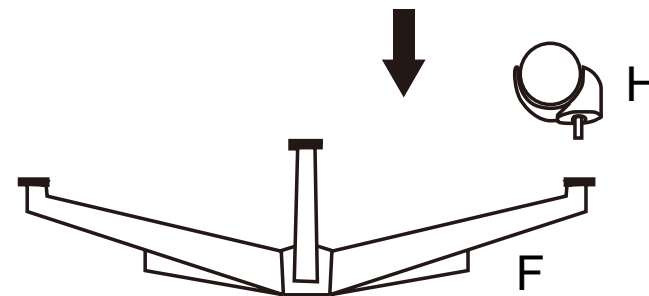
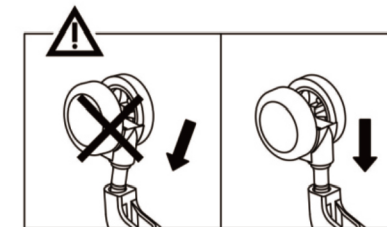

Empuje las ruedas hasta la base.

PASO 2

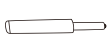
	 x1
---	--

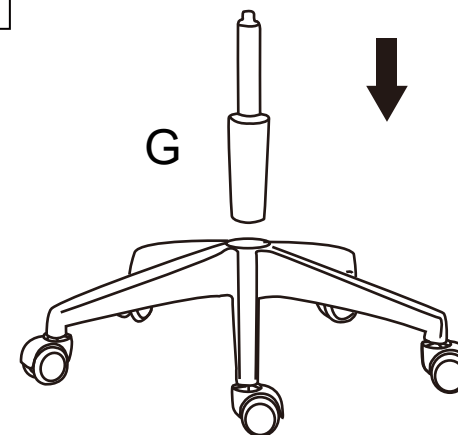



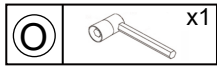

Coloque el elevador a gas en la base.

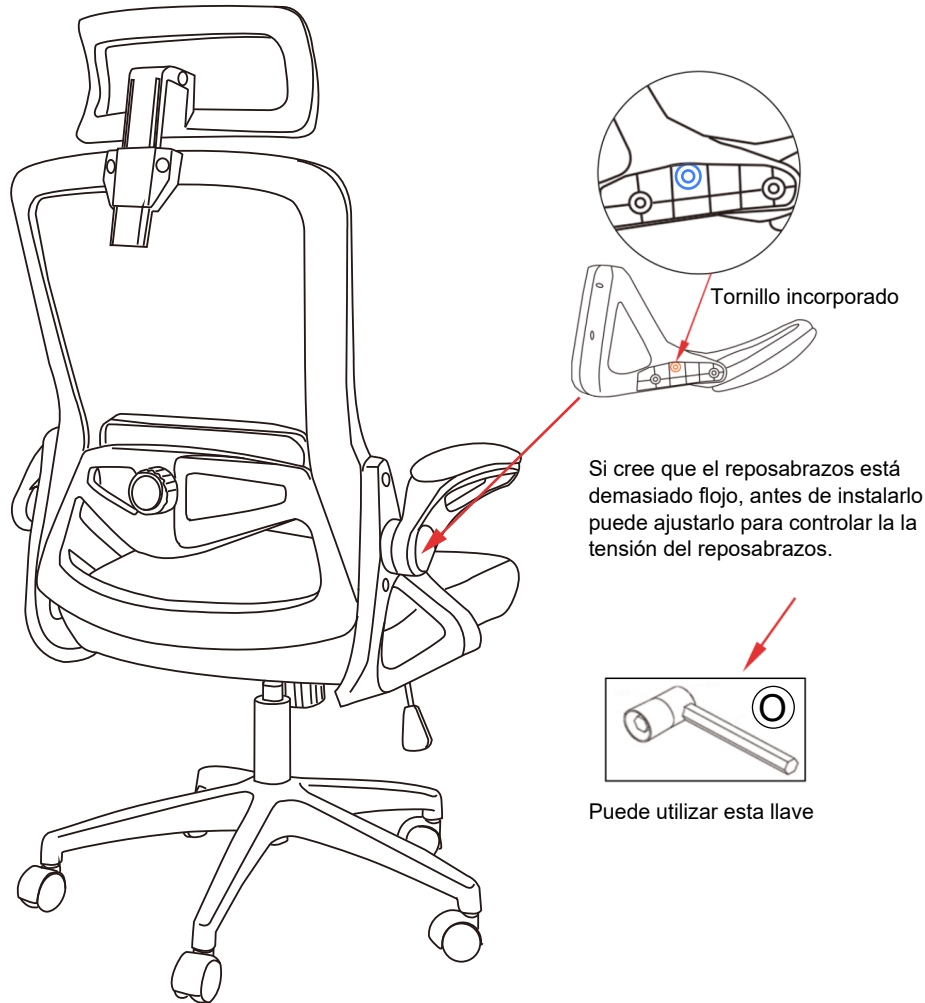

¿Cómo se regula la tensión del reposabrazos?

! Los reposabrazos vienen ajustados de fábrica a la medida ideal.
Si no lo necesita, omítalo por favor.



PASO 3	
(A)	 x1
(C)	 x1
(D)	 x1
(J)	 x4 tornillo corto

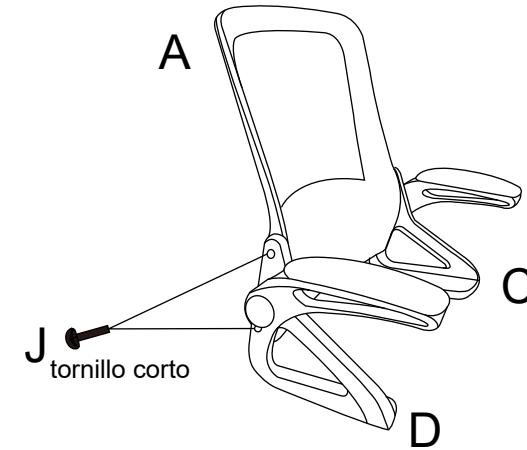

Monte primero el apoyabrazos y el respaldo



Nota: Durante el montaje, por favor, primero apriete a medias todos los tornillos en los agujeros. Una vez colocados todos los tornillos, apriételes a fondo.

PASO 4

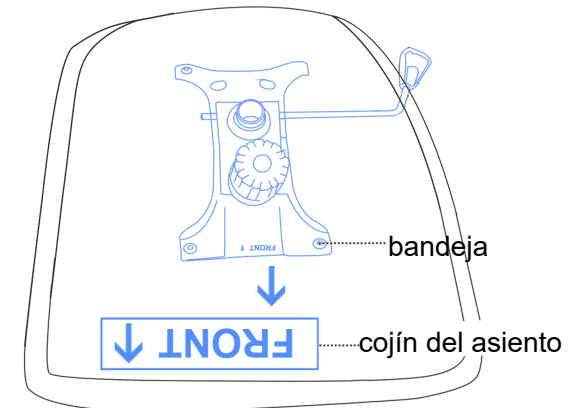

Tenga en cuenta la dirección de la bandeja y del cojín del asiento
Mantenga la misma dirección indicada

PASO 9

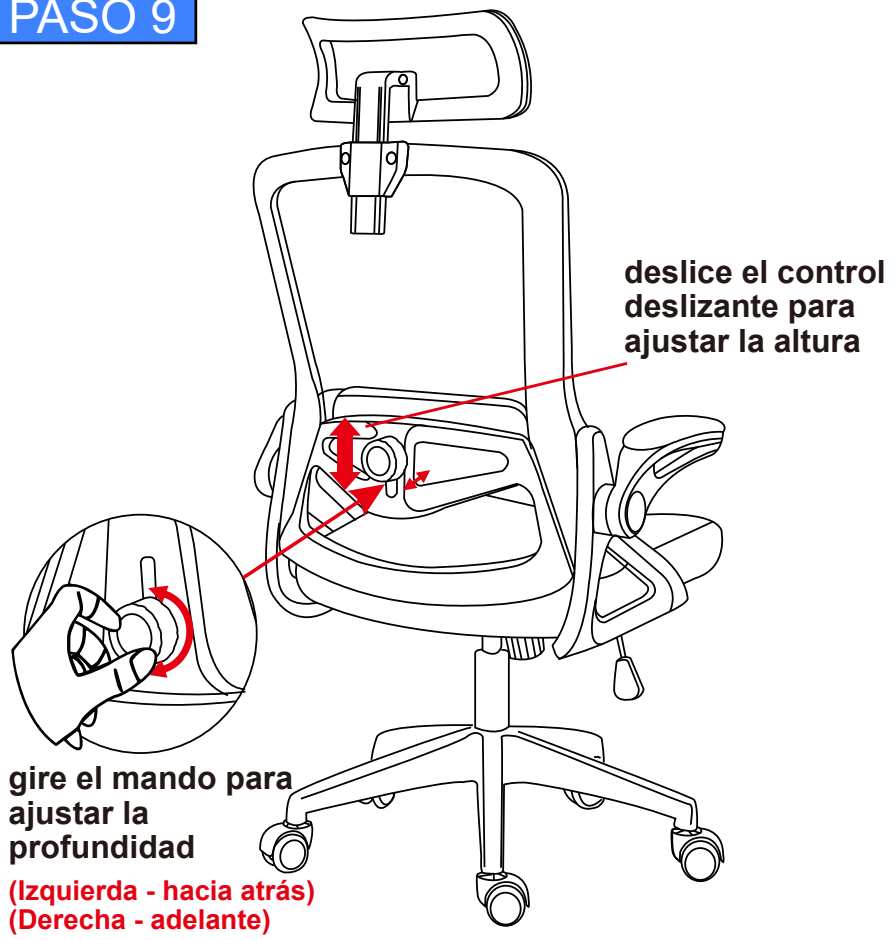

Estructura de acoplamiento Apoyo lumbar
 Para que el ajuste de altura del apoyo lumbar sea suave, por favor primero afloje ligeramente los pomos

PASO 1: Aflojar los pomos
 PASO 2: Deslice el apoyo lumbar hacia arriba y hacia abajo hasta la altura correcta
 PASO 3: Gire el mando para ajustar la profundidad adecuada del "apoyo lumbar a la espalda"

• Método de configuración

Consejo 1: Ajuste de la altura
 presione la palanca para subir y bajar la altura del asiento

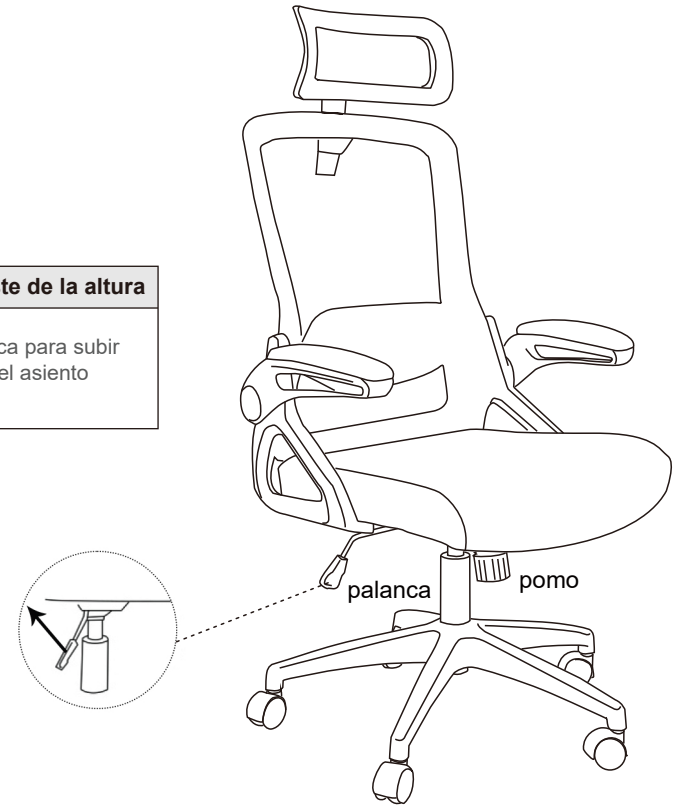

Consejo 2: Ajuste de la tensión de inclinación	
<p>● palanca</p>	<p>● pomo</p>
<p>Paso 1 tire de la palanca para activar el modo balancín</p>	<p>Paso 2 gire el mando para controlar la tensión de inclinación</p>

Múltiples funciones

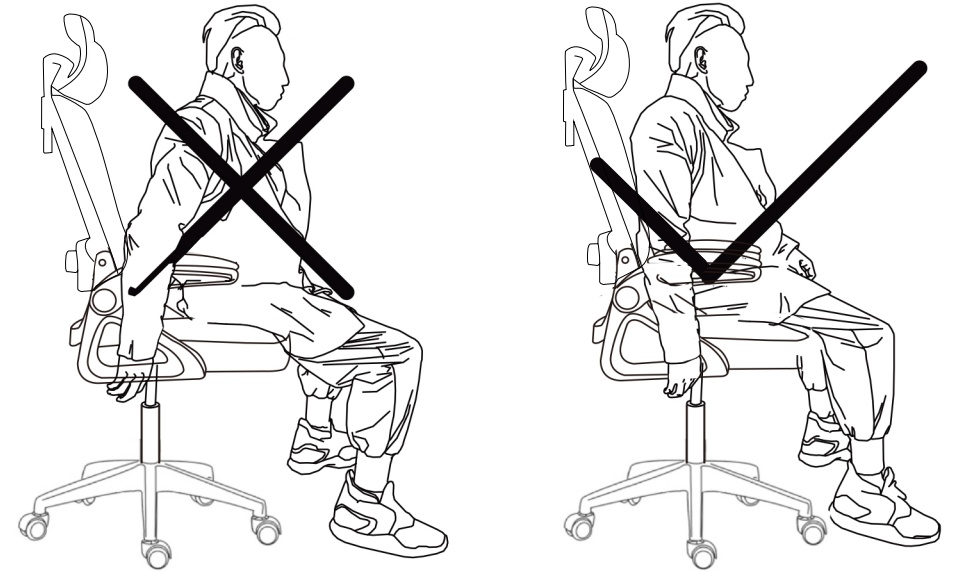
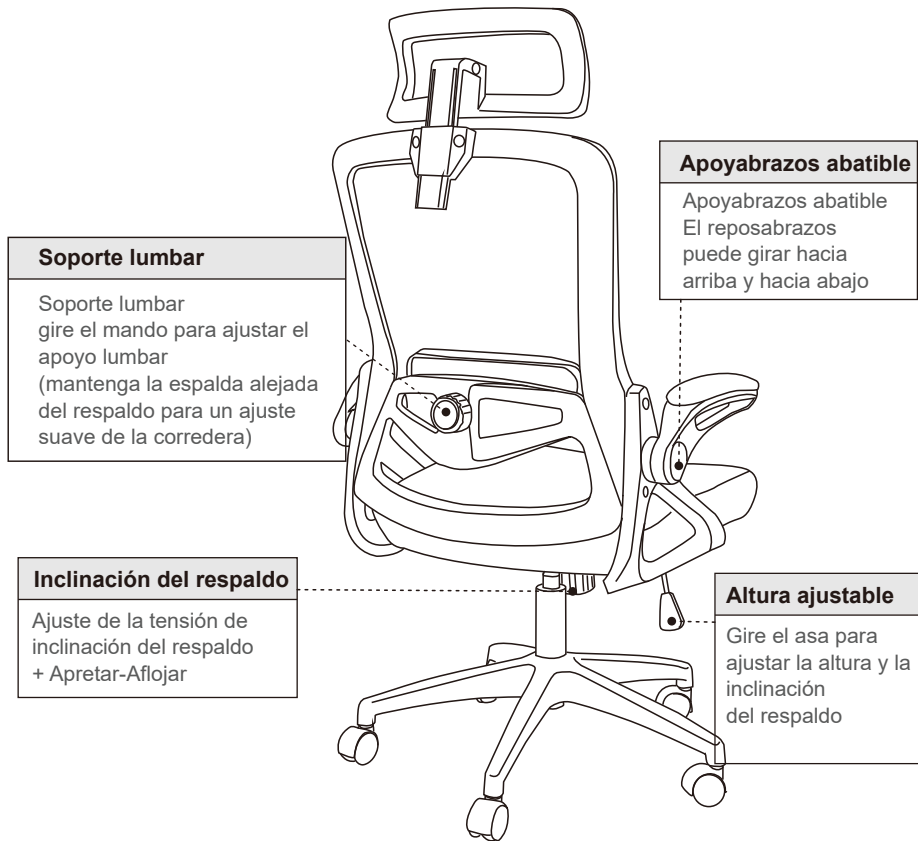

NOTA

Nota: Al bajar la altura del asiento, por favor asegúrese de sentarse completamente en el asiento (como la figura de la derecha muestra a continuación) con el fin de suficiente presión.

PREGUNTAS Y RESPUESTAS

P: ¿Dónde puedo conseguir instrucciones de instalación?

R: También puede ponerse en contacto con nosotros si necesita un documento electrónico de instrucciones o más ayuda.

P: ¿Puedo completar la instalación de forma independiente?

R: si necesita instalar la silla de forma independiente, le recomendamos que coloque el cojín del asiento en una mesa o silla más alta para ayudar a su instalación, por favor consulte nuestras instrucciones.

P: ¿Cómo ajustar si la silla está inclinada hacia delante?

R: Puede ser debido a la orientación incorrecta de la bandeja y el cojín del asiento por favor mantenga la bandeja y el cojín del asiento en la misma dirección que se indica.

P: Si los tornillos no están alineados con los orificios durante la instalación, ¿cómo puedo ajustarlos?

R: Puede colocar primero los tornillos en los orificios correspondientes y apretarlos hasta la mitad. A continuación, apriete completamente todos los tornillos una vez que estén ajustados.

P: ¿Qué debo hacer si al paquete le faltan algunos componentes?

R: No dude en ponerse en contacto con nosotros para obtener ayuda rápida si el paquete carece de algunos componentes.

P: ¿Qué debo hacer si mi paquete resulta dañado?

R: El tránsito de larga distancia puede causar daños al artículo en circunstancias especiales, por favor no dude en contactar con nosotros para obtener ayuda rápida.

Gracias por su apoyo.

Si necesita más ayuda, no dude en ponerse en contacto con nuestro equipo de atención al cliente, haremos todo lo posible para ayudarle.

ATENCIONES

1.Utilice este producto sólo para sentar a una persona a la vez

2.No se suba a la silla ni la utilice como taburete o escalera.

3. No utilice la silla a menos que todos los pernos, tornillos y perillas estén apretados

4.¡No coloque el producto cerca del fuego o de una fuente de calor!

5.¡No utilice limpiadores corrosivos para la limpieza!

6.Este producto no es un parque infantil para que jueguen los niños ya que podría causarles lesiones. Por favor, no deje a los niños desatendidos

Si hay algún problema, no dude en ponerse en contacto con nosotros con

Correo electrónico : homechairserviceeu@hotmail.com

Ciao Amico/a,
Grazie per aver scelto la nostra sedia da ufficio.



La nostra sedia viene fornita con un servizio di garanzia sul prodotto. Qualora dovessi riscontrare dei problemi, ti invitiamo a contattare immediatamente il nostro team di assistenza online, che ti fornirà una soluzione soddisfacente entro 24 ore.

Non esitare a contattarci attraverso i seguenti canali:

Canale 1: Contattaci tramite Amazon

Accedi al tuo Account Amazon

"Il tuo ordine" > trova l'ID dell'ordine > clicca su "Contatta il venditore"

Canale 2: Contatta il nostro team di assistenza online

(E-mail: homechairserviceeu@hotmail.com)

Grazie ancora per il tuo supporto e la tua comprensione!

Componente Danneggiato o Mancante

Re-invia subito il componente da Amazon

Problema di Qualità

1. Invia nuovamente il prodotto da Amazon
-
2. Rimborso Ordine

! IMPORTANTE

Segui le istruzioni per l'uso e usa un tappetino per evitare danni durante il montaggio.

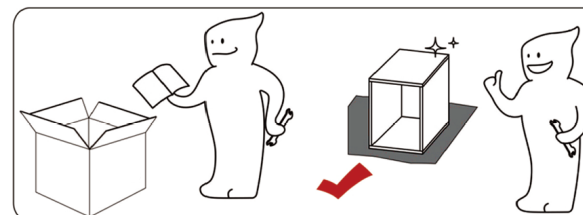
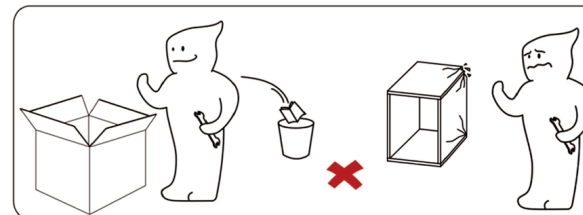

Per un assemblaggio più semplice e migliore, sono necessari 1 o più adulti.



Il tempo previsto per l'assemblaggio di questo prodotto è di 0,5 ore, a seconda delle capacità manipolative individuali.



Prodotto non destinato all'uso da parte dei bambini. Tenere i bambini sotto stretta sorveglianza.



Tenere lontano dal fuoco o da altre fonti di calore.



Non utilizzare detersivi aggressivi per la pulizia!



Si consiglia di indossare guanti protettivi durante l'assemblaggio.



Identificare, ordinare e contare i pezzi prima di procedere all'assemblaggio.



Le avvertenze, le precauzioni e le istruzioni elencate in questo manuale potrebbero non coprire tutte le situazioni che potrebbero verificarsi durante l'utilizzo del prodotto. Se hai bisogno di ulteriore aiuto, contattaci all'indirizzo e-mail homechairserviceeu@hotmail.com

Assicurarsi che tutte le parti siano incluse.

In caso contrario, inviaci un'e-mail a homechairserviceeu@hotmail.com

			
Schienale - 1 pezzo	Cuscino del sedile 1 pezzo	Bracciolo sinistro 1 pezzo	Bracciolo destro 1 pezzo
			
Vassoio - 1 pezzo	Base - 1 pezzo	Ascensore a gas 1 pezzo	ruota - 5 pezzi
	 x10 Vite corta (M6*22mm)	 x4 Vite lunga (M6*35mm)	
Chiave a brugola 1 pezzo	Vite corta - 10 pezzi	Vite lunga - 4 pezzi	Rondella - 8 pezzi
			
Poggiatesta - 1 pezzo	Copertura - 2 pezzi	Chiave a bussola - 1 pezzo	



Avviso: Prima dell'installazione, si prega di classificare la vite, misurare la lunghezza della vite per un facile montaggio (ogni vite viene fornita con 1 backup).

PASSO 1

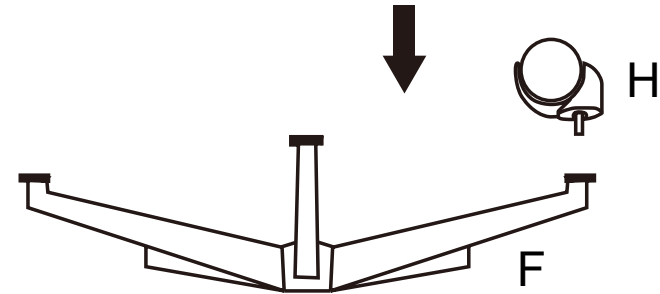
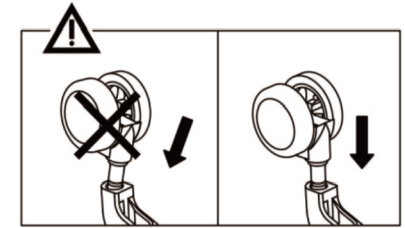
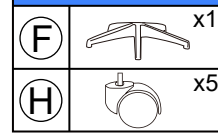

Spingere le ruote verso la base.

PASSO 2

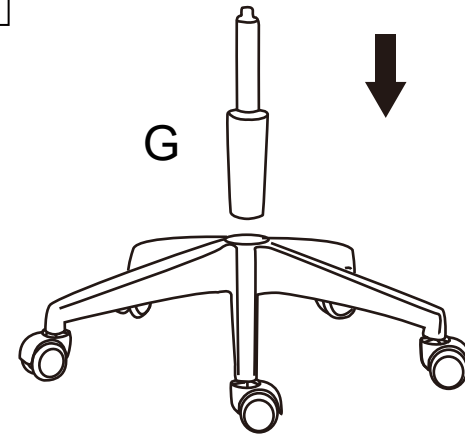

Collocare il sollevatore a gas sulla base.

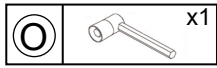

Come regolare la tenuta del bracciolo?

! I braccioli sono regolati in fabbrica per ottenere la tenuta ideale. Se non ne avete bisogno, evitatelo.

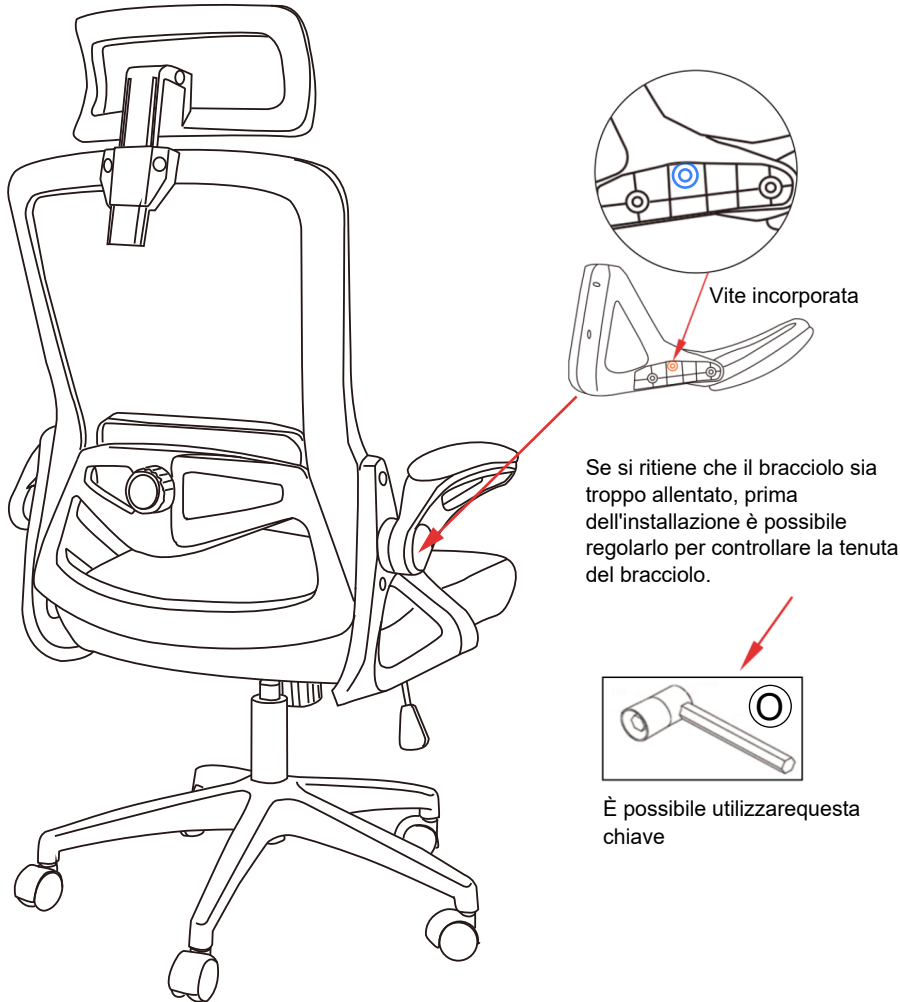

Se si ritiene che il bracciolo sia troppo allentato, prima dell'installazione è possibile regolarlo per controllare la tenuta del bracciolo.

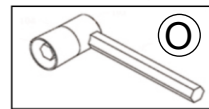

È possibile utilizzare questa chiave

PASSO 3		
(A)		x1
(C)		x1
(D)		x1
(J)		x4 vite corta

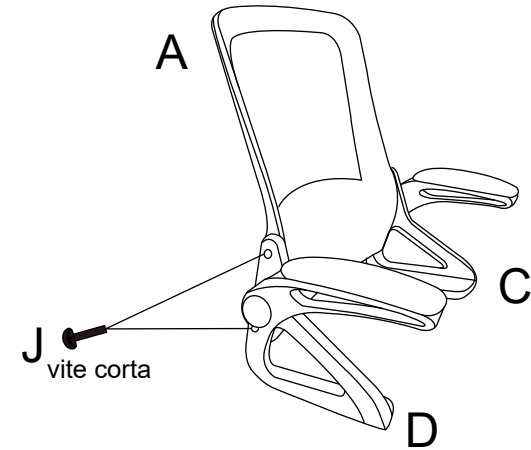

Assemblare prima il bracciolo e lo schienale



NOTA



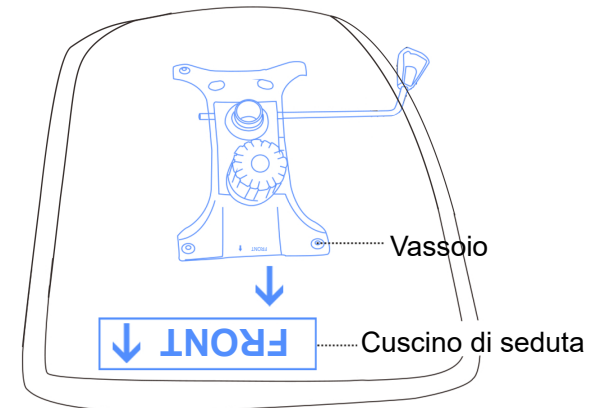

Nota: durante l'assemblaggio, serrare prima tutte le viti a metà nei fori. Dopo aver fissato tutte le viti, serrarle completamente.

PASSO 4



Prestare attenzione alla direzione del vassoio e del cuscino del sedile. Mantenere la stessa direzione indicata

PASSO 5

(B)		x1
(E)		x1
(J)		x4 vite corta
(K)		x4 vite lunga
(L)		x8

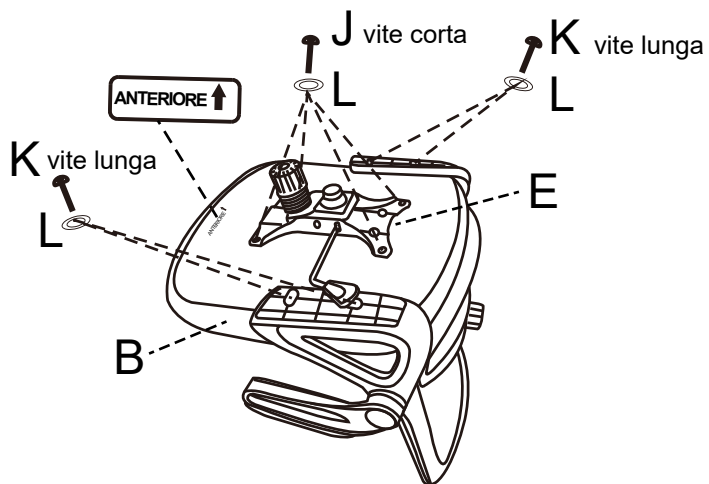

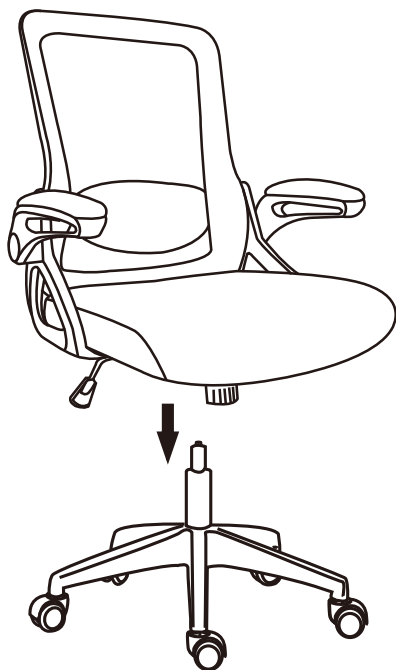

Assemblare prima il bracciolo e il cuscino del sedile.
Successivamente, fissare il meccanismo sul cuscino del sedile.
Prestare attenzione alla direzione!

PASSO 6



Assemblare la sedia con due parti intere

PASSO 7

(J)		x2 vite corta
(M)		x1
(N)		x2

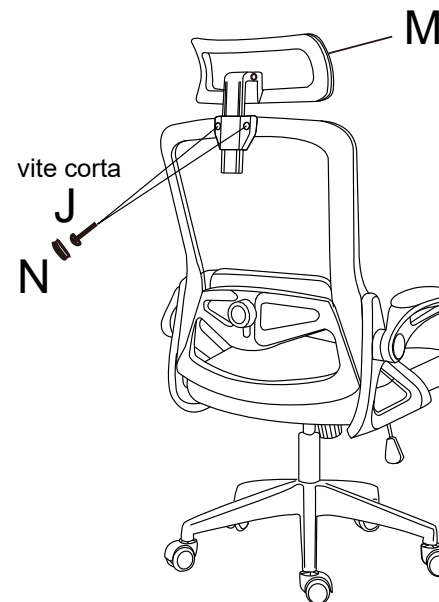

PASSO 8

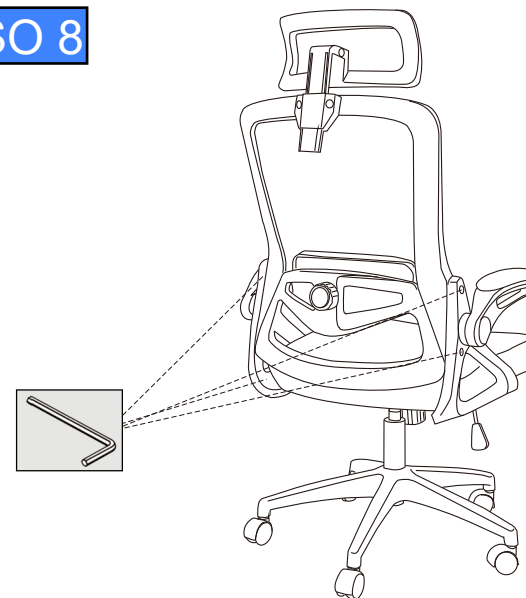

Per una migliore esperienza di utilizzo, dopo che tutte lelevi sonostate tutte le viti, si prega di ruotare ancora una volta per serrarle completamente.

PASSO 9

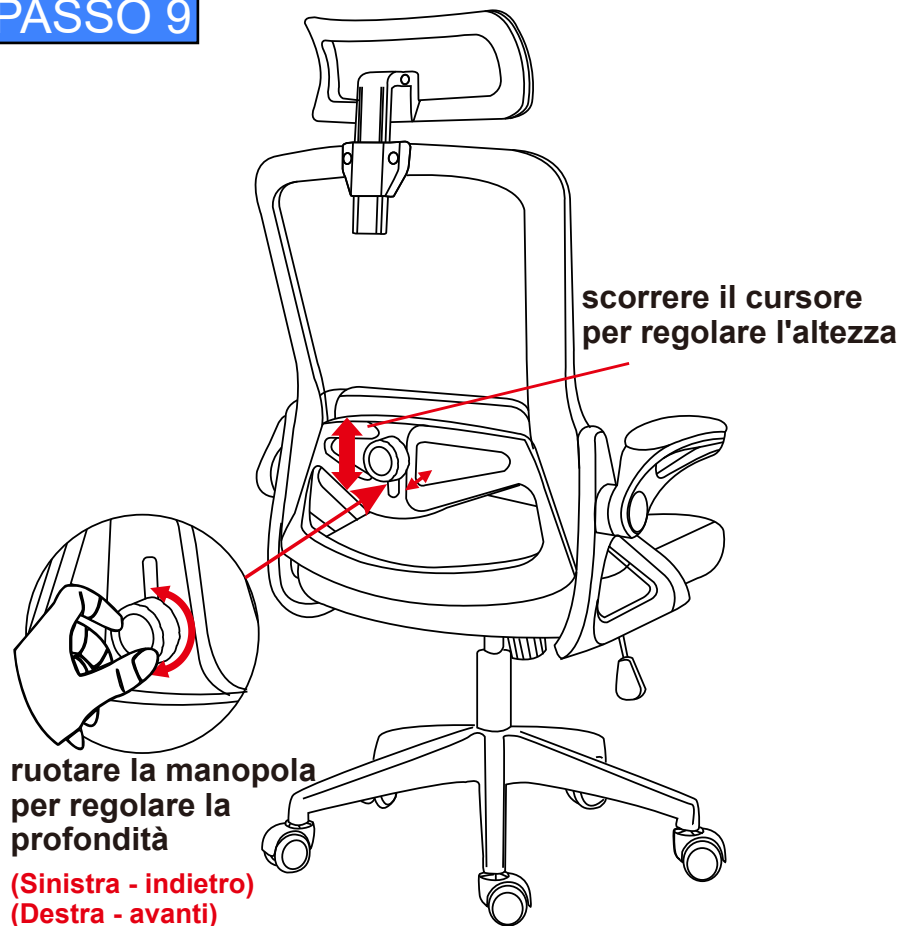

Struttura di collegamento Supporto lombare
Assicurarsi che la regolazione in altezza del supporto lombare sia agevole, allentare leggermente le manopole

Fase 1: Allentare le manopole

Fase 2: Far scorrere il supporto lombare verso l'alto e verso il basso fino all'altezza corretta.

Fase 3: Ruotare la manopola per regolare la profondità adeguata del "supporto lombare alla schiena".

Metodo di impostazione

Suggerimenti 1: regolazione dell'altezza

premere la leva per regolare l'altezza del sedile verso l'alto e verso il basso

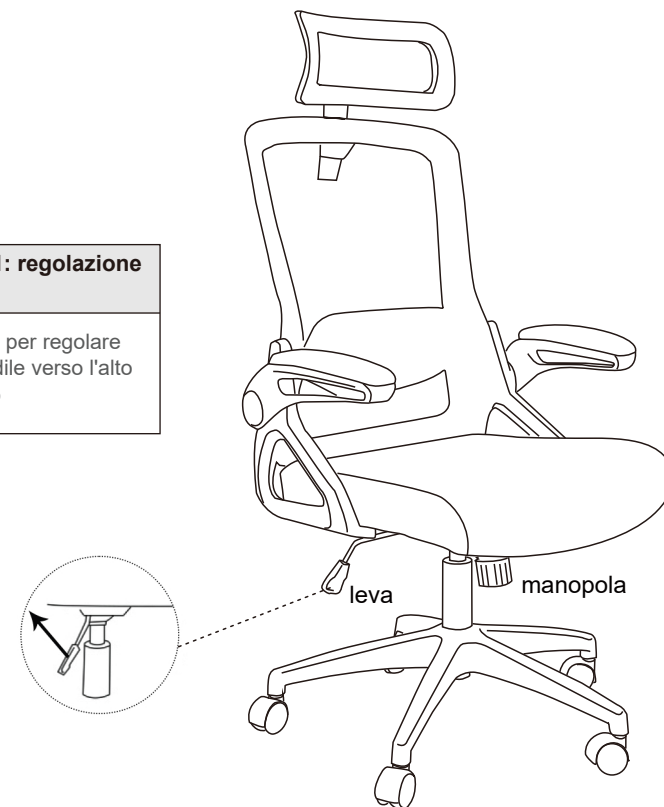

Suggerimenti 2: regolazione della tensione di inclinazione

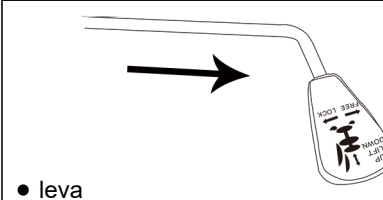

Passo 1
estrarre la leva per attivare la modalità a dondolo

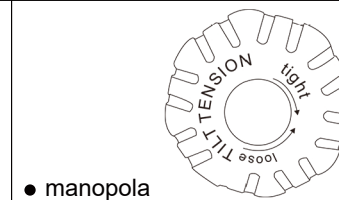

Passo 2
ruotare la manopola per controllare la tensione dell'inclinazione

Funzioni multiple

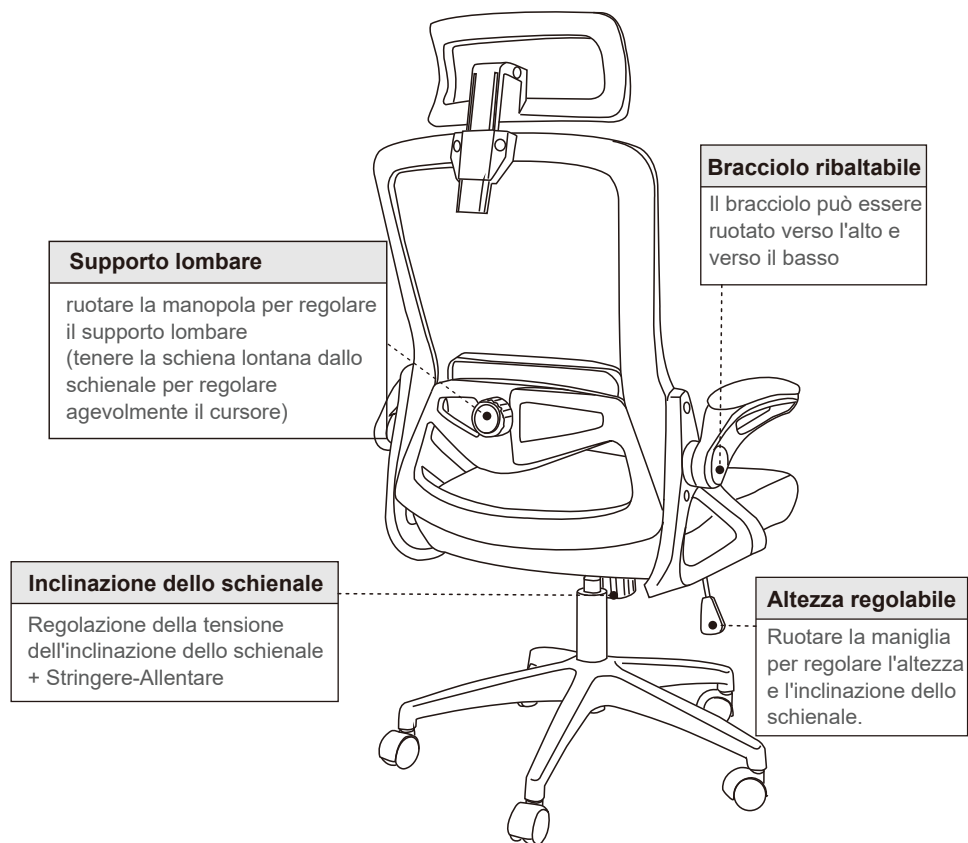

NOTA

Nota: quando si abbassa l'altezza del sedile, assicurarsi di sedersi completamente sul sedile (come mostra la figura a destra) per esercitare una pressione sufficiente.

DOMANDE E RISPOSTE

D: Dove posso trovare le istruzioni per l'installazione?

R: Potete anche contattarci se avete bisogno di un documento di istruzioni elettronico o di ulteriore assistenza.

D: Posso completare l'installazione in modo indipendente?

R: se è necessario installare la sedia in modo indipendente, si consiglia di appoggiare il cuscino del sedile su un tavolo o una sedia più alti per facilitare l'installazione; consultare le nostre istruzioni.

D: Come regolare se la sedia è inclinata in avanti?

R: Potrebbe essere dovuto a un orientamento errato del vassoio e del cuscino del sedile; si prega di mantenere il vassoio e il cuscino del sedile nella stessa direzione indicata.

D: Se le viti non sono allineate con i fori durante l'installazione, come posso regolarle?

R: È possibile inserire prima le viti nei fori corrispondenti e stringerle a metà. Quindi stringere completamente tutte le viti dopo averle fissate.

D: Cosa devo fare se il pacchetto manca di alcuni componenti?

R: Non esitate a contattarci per ricevere un aiuto immediato se il pacchetto manca di alcuni componenti.

D: Cosa devo fare se il mio pacco è danneggiato?

R: Il transito a lunga distanza può causare danni all'articolo in circostanze particolari non esitate a contattarci per un aiuto tempestivo.

Grazie per il vostro supporto!

Se avete bisogno di ulteriore assistenza, non esitate a contattare il nostro servizio clienti per un aiuto immediato faremo del nostro meglio per aiutarvi.

ATTENZIONI

1. Utilizzare questo prodotto solo per far sedere una persona alla volta.

2. Non stare in piedi sulla sedia come sgabello o scala.

3. Non utilizzare la sedia se tutti i bulloni, le viti e le manopole non sono serrati.

4. Non collocare il prodotto vicino al fuoco o a fonti di calore!

5. Non utilizzare detergenti corrosivi per la pulizia!

6. Questo prodotto non è una struttura di arrampicata per il gioco dei bambini, che potrebbe causare lesioni. Si prega di non lasciare i bambini incustoditi

Se c'è qualche problema, non esitate a contattarci con
E-mail: homechairserviceeu@hotmail.com

Hallo Freund,
Vielen Dank, dass Sie sich für unseren Bürostuhl entschieden haben.



Unser Stuhl wird mit einer Produktgarantie geliefert.
Wenn Sie irgendwelche Probleme haben, wenden Sie sich bitte sofort an unser Online-Service-Team, das Ihnen innerhalb von 24 Stunden eine zufriedenstellende Lösung bieten wird.

Bitte kontaktieren Sie uns über den folgenden Weg:

Weg 1: Kontaktieren Sie uns über Amazon

Anmelden bei Ihrem Amazon-Konto

"Ihre Bestellung" > Suchen Sie die Bestell-ID > Klicken Sie auf "Verkäufer kontaktieren".

Weg 2: Kontaktieren Sie unser Online-Service-Team

(E-Mail: homechairserviceeu@hotmail.com)

Nochmals vielen Dank für Ihre Unterstützung und Ihr Verständnis!

Beschädigtes oder fehlendes Bauteil

Komponente umgehend erneut von uns senden

Qualitätsproblem

1. Senden Sie das Produkt umgehend erneut von uns
- OR**
2. Bestellung Erstattung

! WICHTIG

Bitte stellen Sie sicher, dass alle Teile enthalten sind
Bitte beachten Sie die Gebrauchsanweisung und verwenden Sie eine Unterlage, um Beschädigungen bei der Montage zu vermeiden.

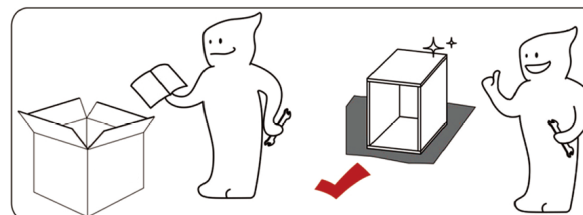
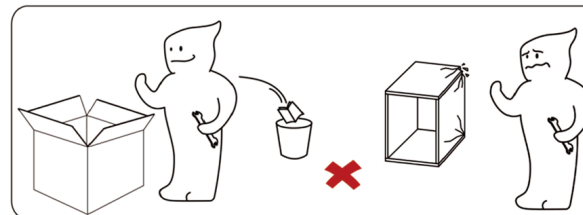

Für eine einfachere und bessere Montage sind 1 oder mehrere Erwachsene erforderlich



Die erwartete Montagezeit für dieses Produkt beträgt 0,5 h, abhängig von den manipulativen Fähigkeiten des Einzelnen.



Nicht für den Gebrauch durch Kinder bestimmt. Bitte



Von Feuer oder anderen Wärmequellen fernhalten.



Verwenden Sie zur Reinigung keine scharfen Reinigungsmittel!



Wir empfehlen, bei der Montage Schutzhandschuhe zu tragen.













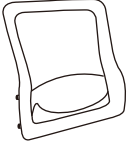

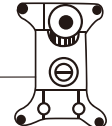

Identifizieren, sortieren und zählen Sie die Teile vor dem Zusammenbau.

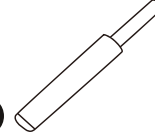

Die in diesem Handbuch aufgeführten Warnungen, Vorsichtshinweise und Anweisungen decken möglicherweise nicht alle möglichen Situationen ab, die bei der Verwendung des Produkts auftreten können. Bitte kontaktieren Sie US über homechairserviceeu@hotmail.com wenn Sie weitere Hilfe benötigen.

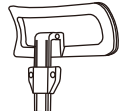

Bitte stellen Sie sicher, dass alle Teile enthalten sind.

Wenn nicht, senden Sie uns eine E-Mail an homechairserviceeu@hotmail.com

			
Rückenlehne - 1Stück	Sitzkissen - 1Stück	Linke Armlehne - 1Stück	Rechte Armlehne 1Stück
			
Tablett - 1Stück	Sockel - 1Stück	Gaslift - 1Stück	Rad - 5Stück
	 x10 Kurze Schraube (M6*22mm)	 x4 Lange Schraube (M6*35mm)	
Inbusschlüssel 1Stück	Kurze Schraube 10Stück	Lange Schraube 4Stück	Unterlegscheibe 8Stück
			
Kopfstütze - 1Stück	Abdeckung - 2Stück	Steckschlüssel - 1Stück	



inweis: Vor der Installation, bitte klassifizieren Sie die Schraube, messen Sie die Schraubenlänge für eine einfache Montage (Jede Schraube kommt mit 1 Backup)

SCHRITT 1	
	x1
	x5

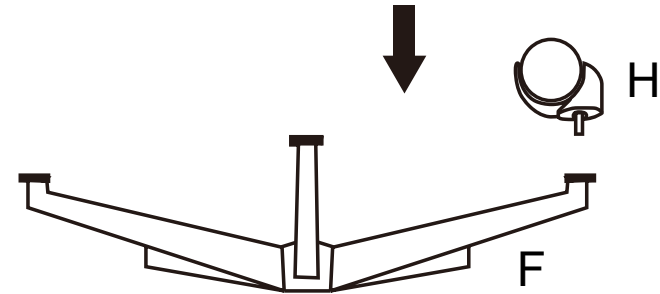
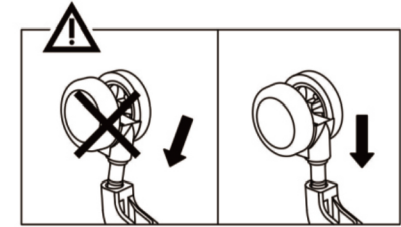

Schieben Sie die Räder auf den Sockel.

SCHRITT 2	
	x1

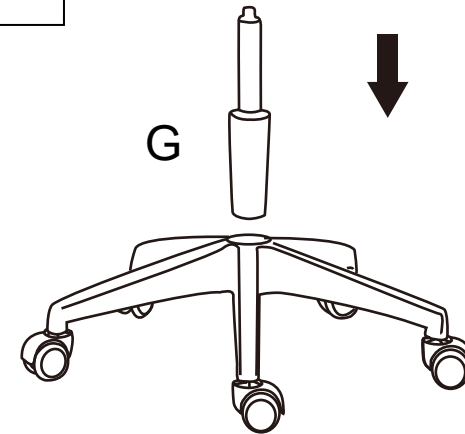

Setzen Sie den Gaslift auf den Sockel.

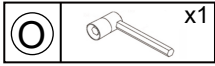

Wie lässt sich die Armlehne straff einstellen?

! Die Armlehnen sind werksseitig auf die ideale Spannung eingestellt.
Wenn Sie sie nicht brauchen, lassen Sie sie bitte weg.

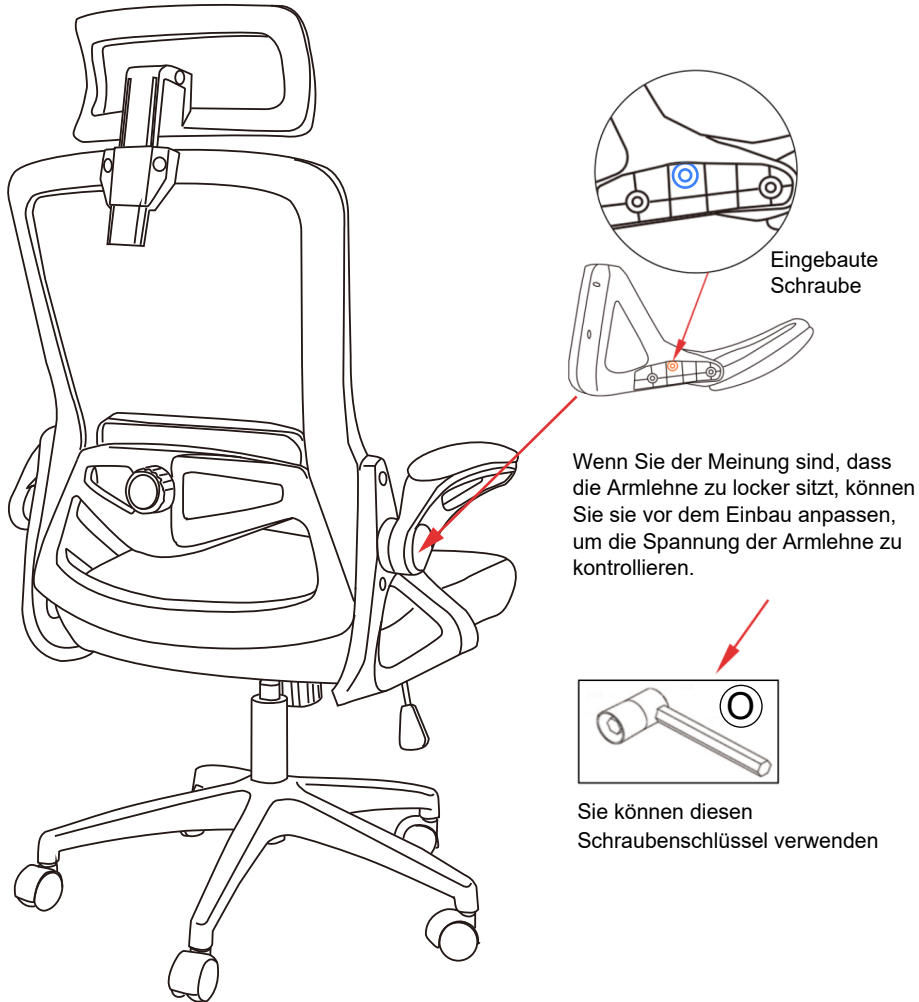

SCHRITT 3	
(A)	x1
(C)	x1
(D)	x1
(J)	x4 kurze Schraube

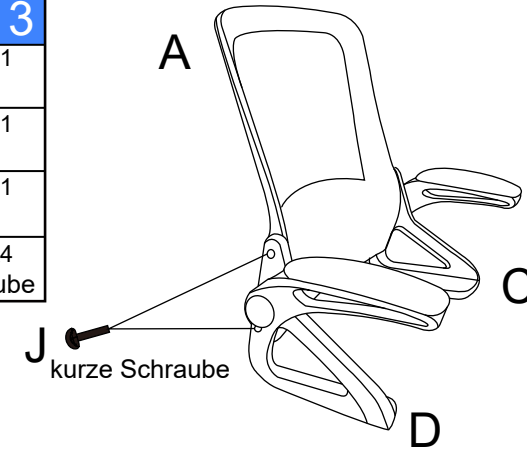

Montieren Sie zuerst die Armlehne und den Rücken



HINWEIS



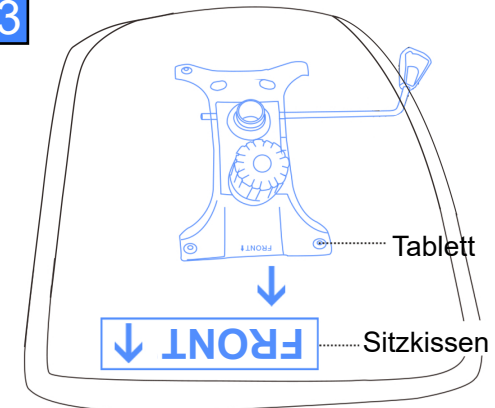

Hinweis: Ziehen Sie bei der Montage zunächst alle Schrauben in den Löchern halb fest. Nachdem alle Schrauben fest sind, ziehen Sie sie vollständig an.

SCHRITT 3



Bitte beachten Sie die Richtung des Tablett und des Sitzkissens
Halten Sie die gleiche Richtung wie angegeben

SCHRITT 5

(B)	 x1
(E)	 x1
(J)	 x4 kurze Schraube
(K)	 x4 lange Schraube
(L)	 x8

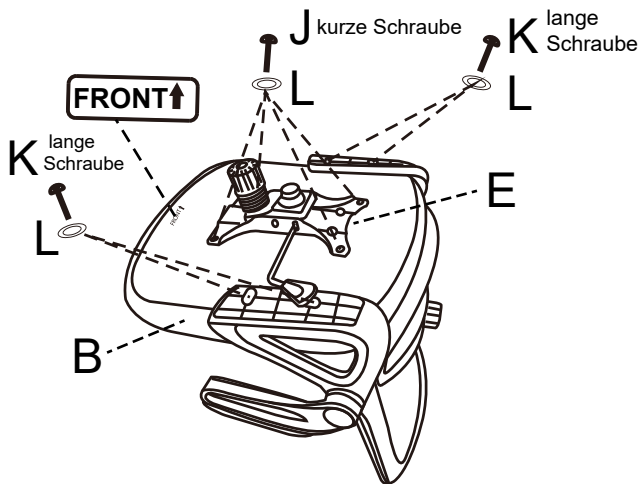

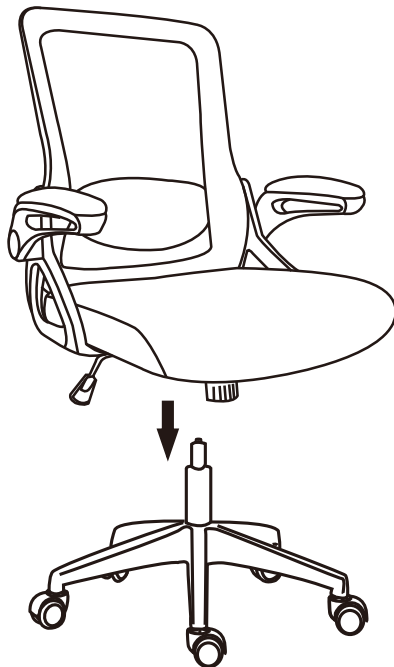

Montieren Sie zuerst die Armlehne und das Sitzkissen. Danach befestigen Sie den Mechanismus am Sitzkissen. Bitte beachten Sie die Richtung!

SCHRITT 6



Montieren Sie den Stuhl aus zwei ganzen Teilen

SCHRITT 7

(J)	 x2 kurze Schraube
(M)	 x1
(N)	 x2

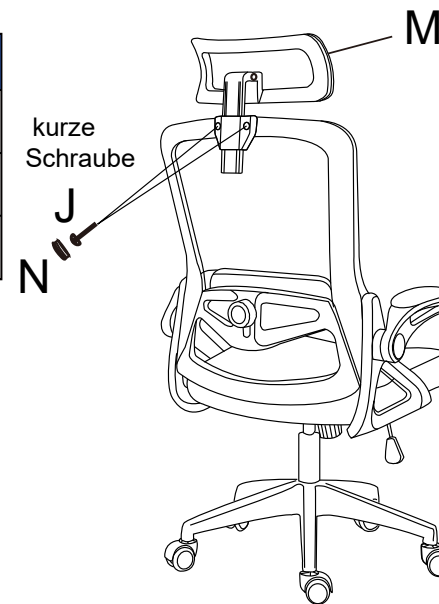

SCHRITT 8

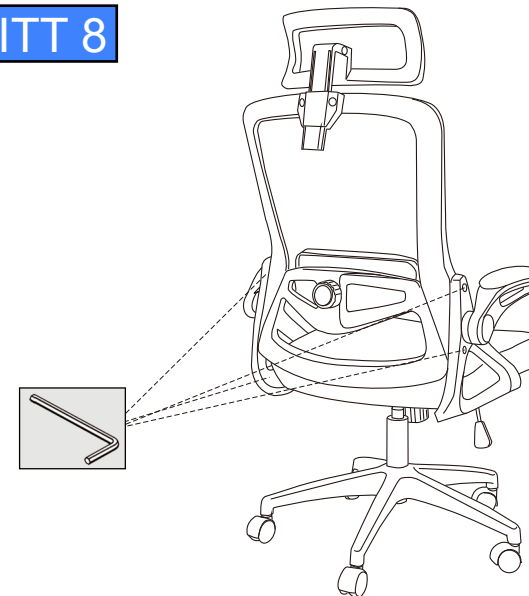

Für eine bessere Erfahrung bei der Verwendung, nachdem alle Schrauben eingestellt sind, drehen Sie bitte noch einmal, um sie vollständig festzuziehen

SCHRITT 9

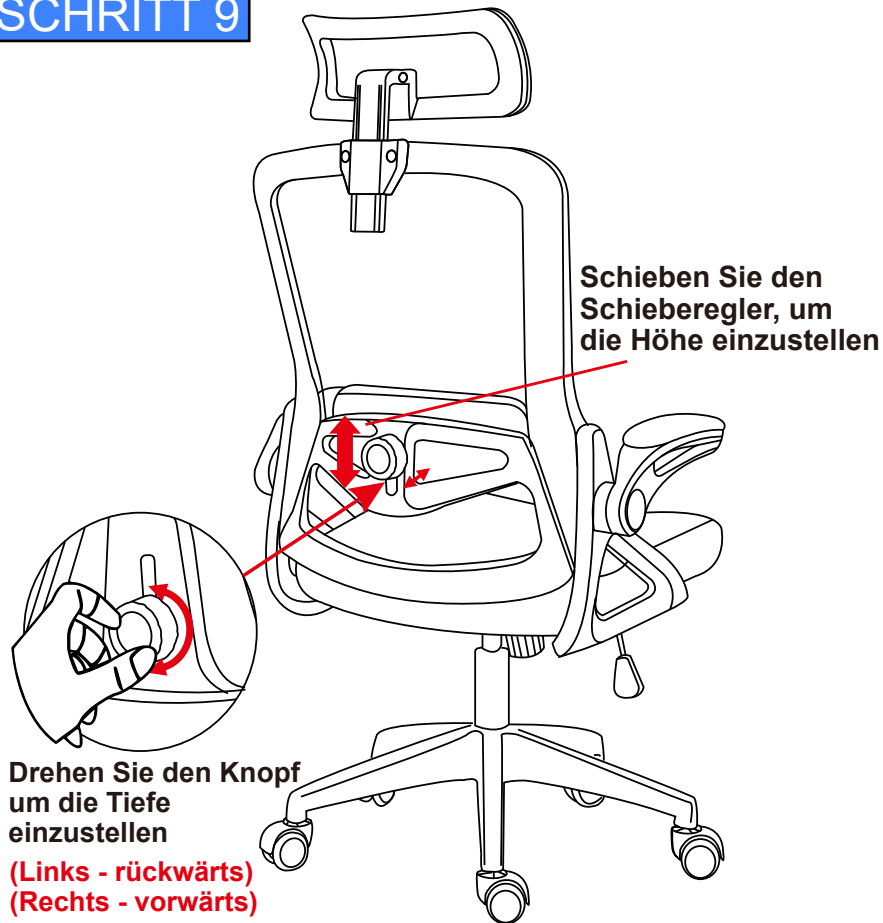

Gestänge Struktur Lendenwirbelstütze
Damit die Höhenverstellung der Lendenwirbelstütze leichtgängig ist, bitte lösen Sie zunächst die Knöpfe leicht

Schritt 1: Lösen Sie die Drehknöpfe

Schritt 2: Schieben Sie die Lendenwirbelstütze nach oben und unten auf die richtige Höhe

Schritt 3: Drehen Sie den Knopf, um die geeignete Tiefe der "Lendenwirbelstütze-zum-Rücken" einzustellen.

Einrichtung Methode

Tipps 1: Höhenverstellung

Drücken Sie den Hebel, um die Sitzhöhe nach oben und unten zu verstellen.

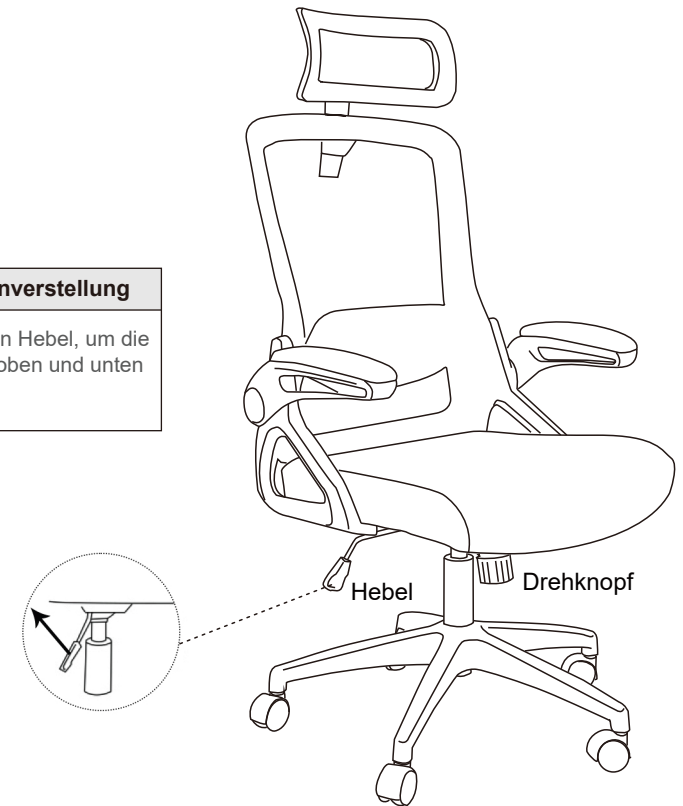

Tipps 2: Einstellung der Neigungsspannung

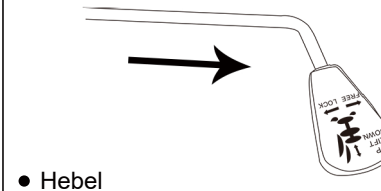

● Hebel

Schritt 1

Ziehen Sie den Hebel heraus, um den Schaukelmodus zu aktivieren

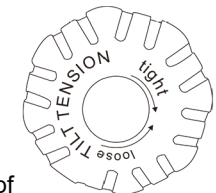

● Drehknopf

Schritt 2

Drehen Sie den Drehknopf, um die Neigungsspannung zu regulieren.

Mehrere Funktionen

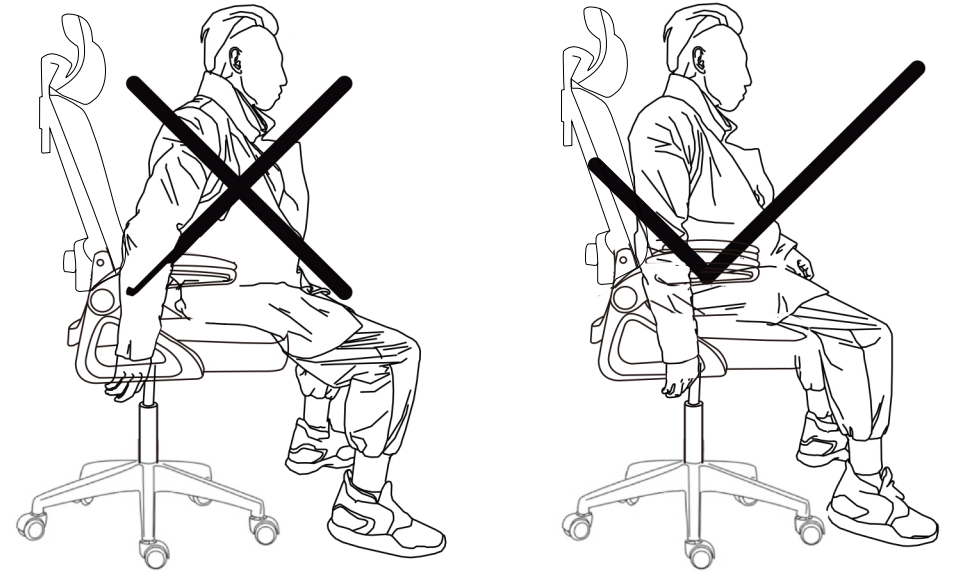
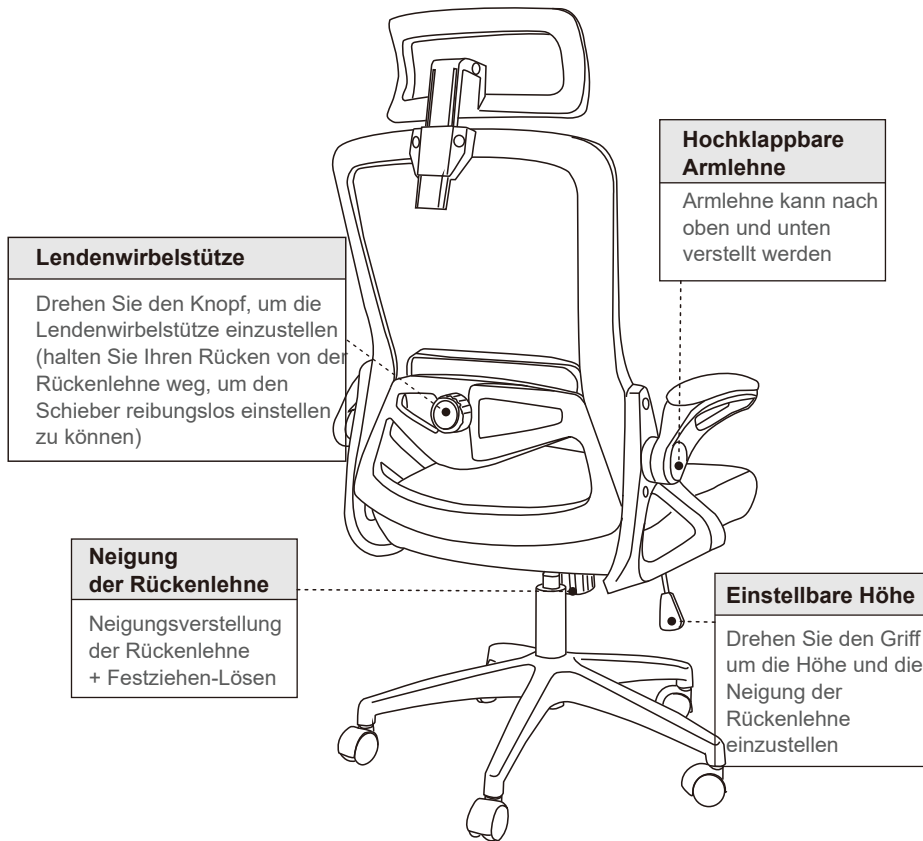

ANMERKUNG

Hinweis: Beim Absenken der Sitzhöhe müssen Sie sich ganz auf den Sitz setzen (wie in der rechten Abbildung unten gezeigt), um genügend Druck auszuüben.

FRAGEN UND ANTWORTEN

F: Wo kann ich eine Installationsanleitung erhalten?

A: Sie können uns auch kontaktieren, wenn Sie eine elektronische Anleitung oder weitere Unterstützung benötigen.

F: Kann ich die Installation selbstständig durchführen?

A: Wenn Sie den Stuhl selbstständig montieren müssen, empfehlen wir Ihnen, das Sitzkissen auf einen höheren Tisch oder Stuhl zu legen, um die Montage zu erleichtern. Bitte beachten Sie unsere Anleitung.

F: Wie lässt sich der Stuhl einstellen, wenn er nach vorne gekippt ist?

A: Es kann an der falschen Ausrichtung des Tablett und des Sitzkissens liegen. Bitte halten Sie das Tablett und das Sitzkissen in der gleichen Richtung wie angegeben.

F: Wie kann ich die Schrauben justieren, wenn sie beim Einbau nicht auf die Löcher ausgerichtet sind?

A: Sie können die Schrauben zuerst in die entsprechenden Löcher stecken und sie halb festziehen. Ziehen Sie dann alle Schrauben vollständig an, nachdem die Schrauben eingestellt sind.

F: Was soll ich tun, wenn dem Paket einige Komponenten fehlen?

A: Bitte zögern Sie nicht, uns zu kontaktieren, um sofortige Hilfe zu erhalten, wenn dem Paket einige Komponenten fehlen.

F: Was sollte ich tun, wenn mein Paket beschädigt wurde?

A: Langstrecken-Transit kann Schäden an dem Element unter besonderen Umständen verursachen, bitte zögern Sie nicht, uns für schnelle Hilfe zu kontaktieren.

Vielen Dank für Ihre Unterstützung!

Wenn Sie weitere Unterstützung benötigen, wenden Sie sich bitte an unseren Kundenservice für schnelle Hilfe, wir werden unser Bestes tun, um Ihnen zu helfen.

ATTENTIONS

1. dieses Produkt nur für die Bestuhlung von jeweils einer Person verwenden

2. stehen nicht auf dem Stuhl verwenden, wie ein Hocker oder Leiter

3. Benutzen Sie den Stuhl nicht, wenn nicht alle Bolzen, Schrauben und Knöpfe fest angezogen sind.

4. stellen Sie das Produkt nicht in die Nähe von Feuer oder Wärmequellen !

5. keine ätzenden Reinigungsmittel zur Reinigung verwenden!

6. dieses Produkt ist kein Klettergerüst für Kinder, das zu Verletzungen führen kann. Bitte lassen Sie Kinder nicht unbeaufsichtigt

Wenn es irgendein Problem gibt, zögern Sie nicht uns zu kontaktieren mit

E-Mail: homechairserviceeu@hotmail.com

EC/REP

Name: Sea&Mew Consulting GmbH
Address: Mittenhuber Straße 4, 92318 Neumarkt
Email: Compliance.EU@outlook.com
Contact Person: Yuan Li
Tel: +4915224685061

Made in China

