

Model: \_\_\_\_\_

Lot No: \_\_\_\_\_

Date of Purchase: \_\_\_\_\_

**2** Install the table leg supports (C) with available hardware (L).

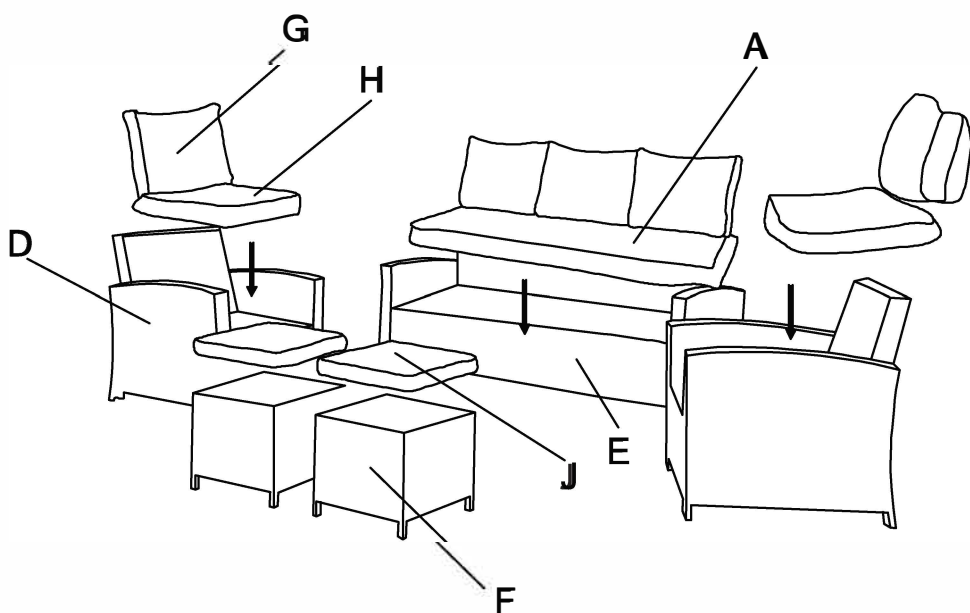

## 6 Pc Set

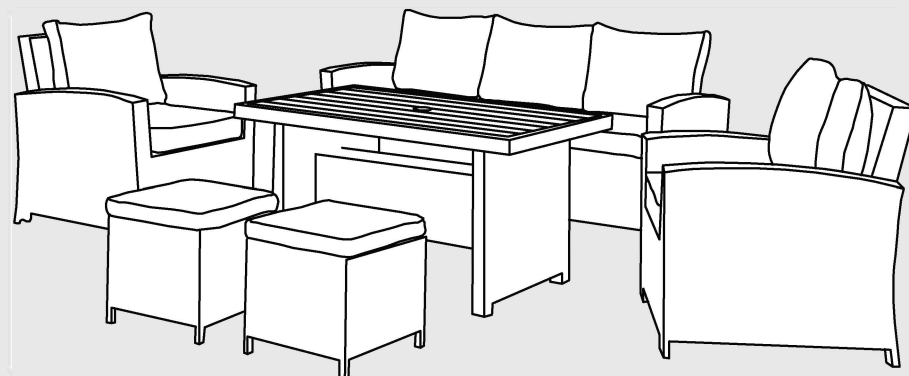

### ADULT ASSEMBLY REQUIRED

If you are missing any parts or have any questions regarding assembly, do not return this item to the retailers store. Please call our toll-free customer service number and have this assembly manual open to the parts list ready to provide the model name, and part name or number.



**WARNING:** This product may contain small components, please ensure they are kept away from small children.

## PARTS AND HARDWARE

Avoid using sharp objects such as a knife to cut open packing as you may accidentally damage the upholstery.

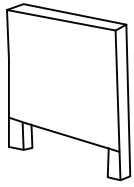

A. Table Legs  
2x

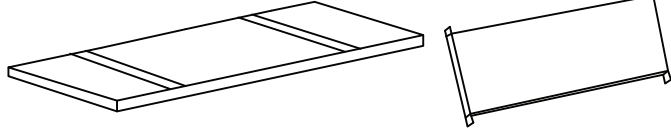

B. Table Top  
1x

C. Table Leg Support  
2x

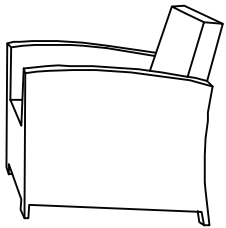

D. Chair  
2x

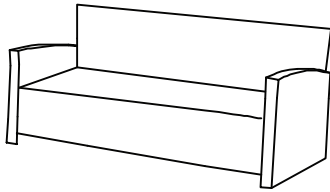

E. Loveseat Chair  
1x

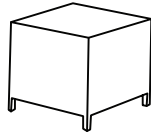

F. Box Chair  
2x

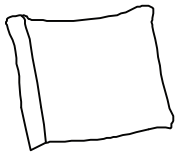

G. Backrest  
5x



H. Chair Cushion  
2x

I. Loveseat Cushion  
1x



J. Box Cushion  
2x

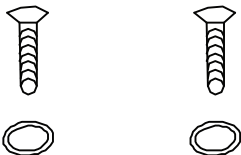

K. Bolt 4x  
Washer 4x

L. Bolt 8x  
Washer 8x

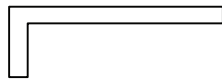

M. Allen Key  
1x

## ASSEMBLY INSTRUCTIONS

Do not fully tighten bolts until assembly is complete.

- 1 Flip table (B) top upside-down onto a smooth flat surface, attach the table legs (A) with available hardware (K).

