

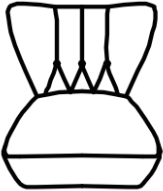



# ASSEMBLY INSTRUCTION

## ACCENT CHAIR

**NOTE: Do not use power tools for assembly. Power tools increase the risk of over tightening which lead to splitting or cracking the wood.**

### COMPONENT LIST

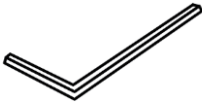
NO.	DRAWING	QTY	DESCRIPTION
A		1	SEAT
B		2	WOODEN FRONT LEG WITH PLASTIC CAP(H9.25")
C		2	WOODEN REAR LEG WITH ADJUSTED CAP(H8.25")
D		12	BOLT(9/10"*1/2")
E		1	ALLEN KEY (1-1/10"*2-9/10")

**Please follow the drawings below to assemble the item.**

**Step 1. Wooden legs are stored in the box at the bottom of chair, please take out for assembly.**

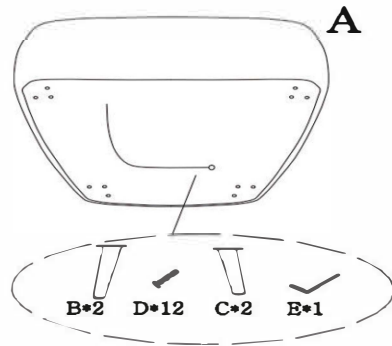

**Step 2. Align the legs onto the pre-drilled holes at the bottom of unit, insert bolts then tighten with Allen key.**

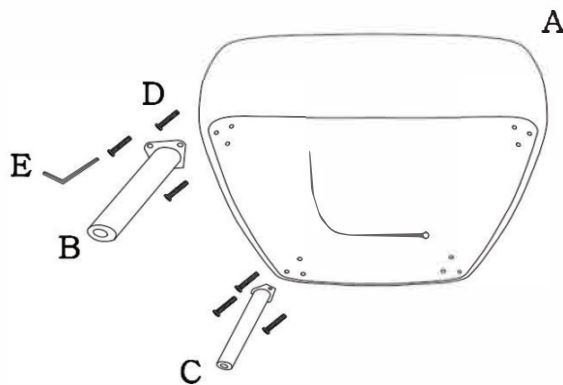

**Step 3. Completed!**

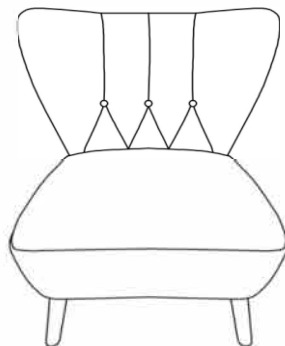

### **CARE INSTRUCTION FOR 100% POLYESTER FURNITURE**

- **Avoid exposing furniture directly to sunlight or heating and air conditioning outlets. Exposure to sunlight or heating and air conditioning outlets will fade/damage 100% polyester.**
- **Wipe gently with a damp soft cloth to remove dust, dirt and any grime buildup.**



**For items use on wooden floor, hard surfaces or carpets, it is recommended to install protective pads under all legs and supports to avoid/prevent from damages/scratches and discoloration**