

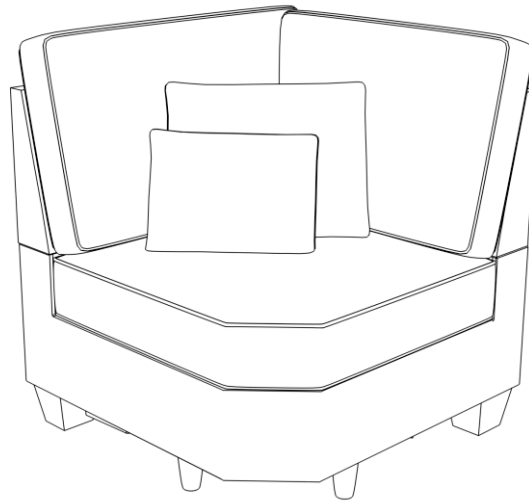













# ASSEMBLY INSTRUCTION



## PARTS LIST

				
<b>A</b> x1	<b>B</b> x1	<b>C</b> x1	<b>D</b> x1	<b>E</b> x1
				
<b>F</b> x1	<b>G</b> x1	<b>H</b> Leg x3		

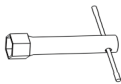
## HARDWARE LIST

				
<b>1</b> Bolt x4	<b>2</b> Nut x4	<b>3</b> Washer x4	<b>4</b> Wrench x1	<b>5</b> SUPPORT Legs x2

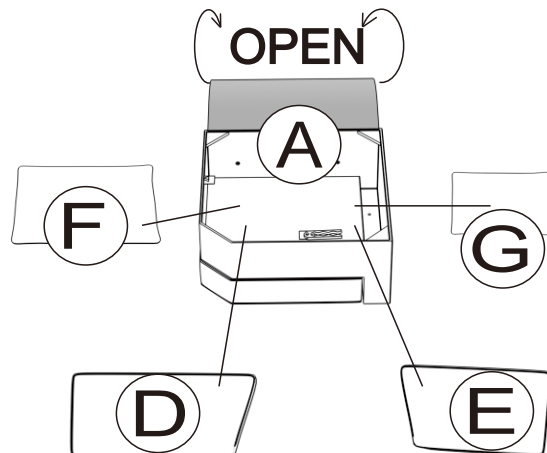

# Step1

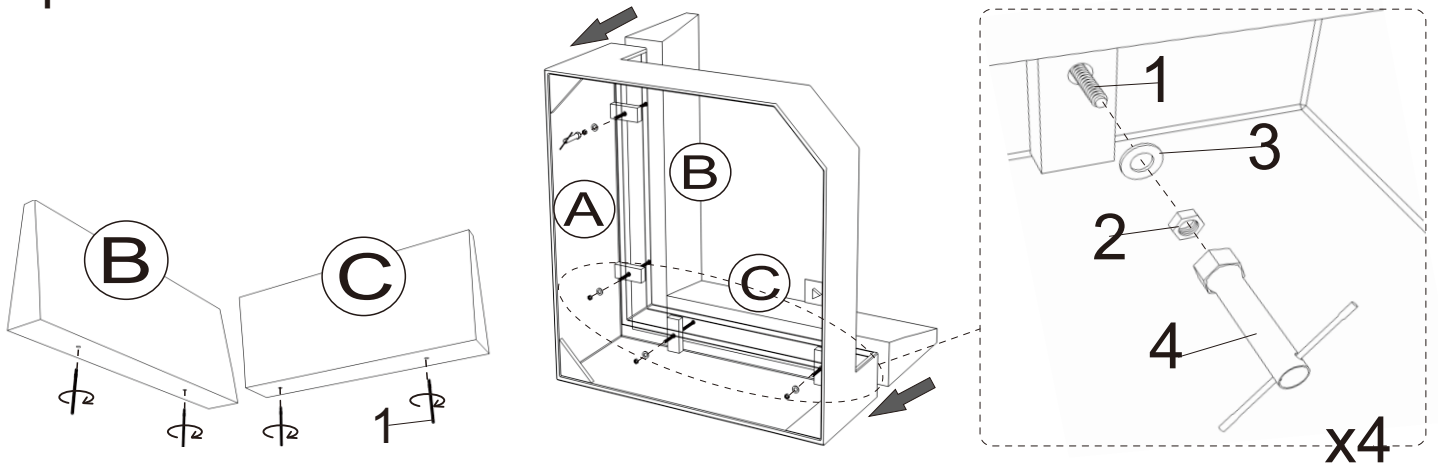

# Step2

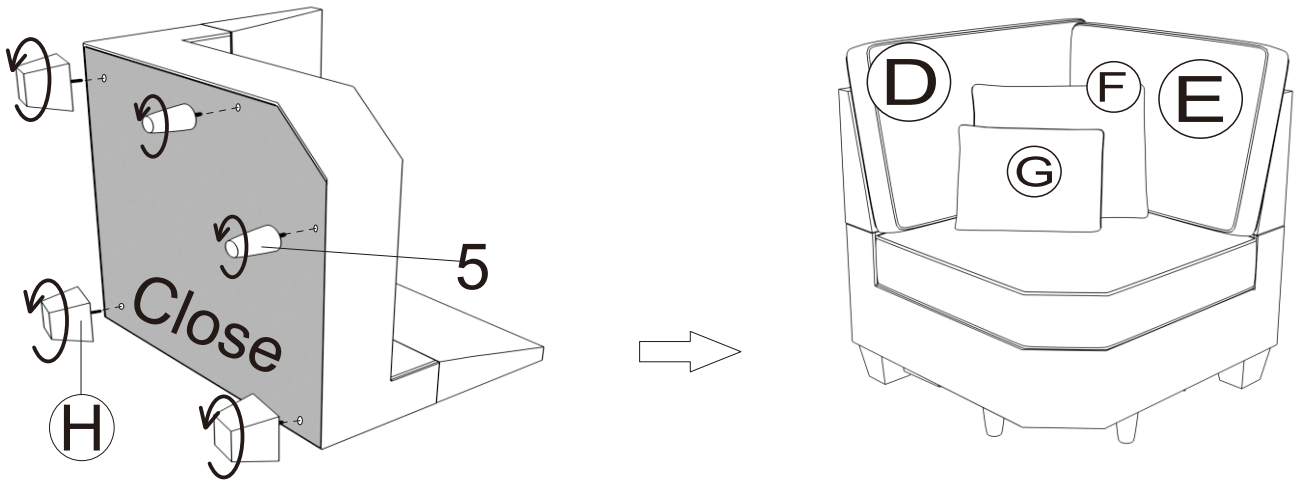

Launch the bottom connector.

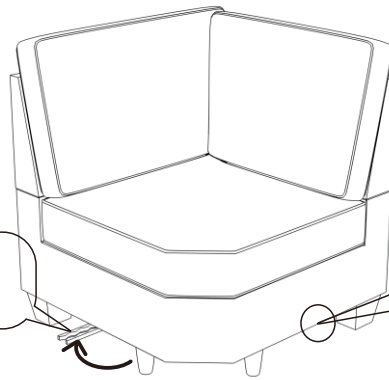

this is the bottom connector.



Can be combined with the same series of products.

