

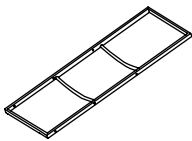

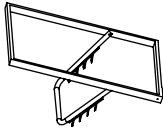

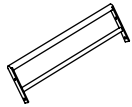





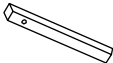



Ax2 	Bx1 	Cx1 	Dx1 	
Ex1 	Fx2 	Gx2 	Hx2  M8x100	
Ix8  M6x45	Jx6  M6x60	Kx26  M6	Lx4  M8	Mx2  M6x4
Nx2  M8x15	Ox12  M6	Px2  M8	Qx1 	Rx1 

1



2

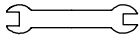
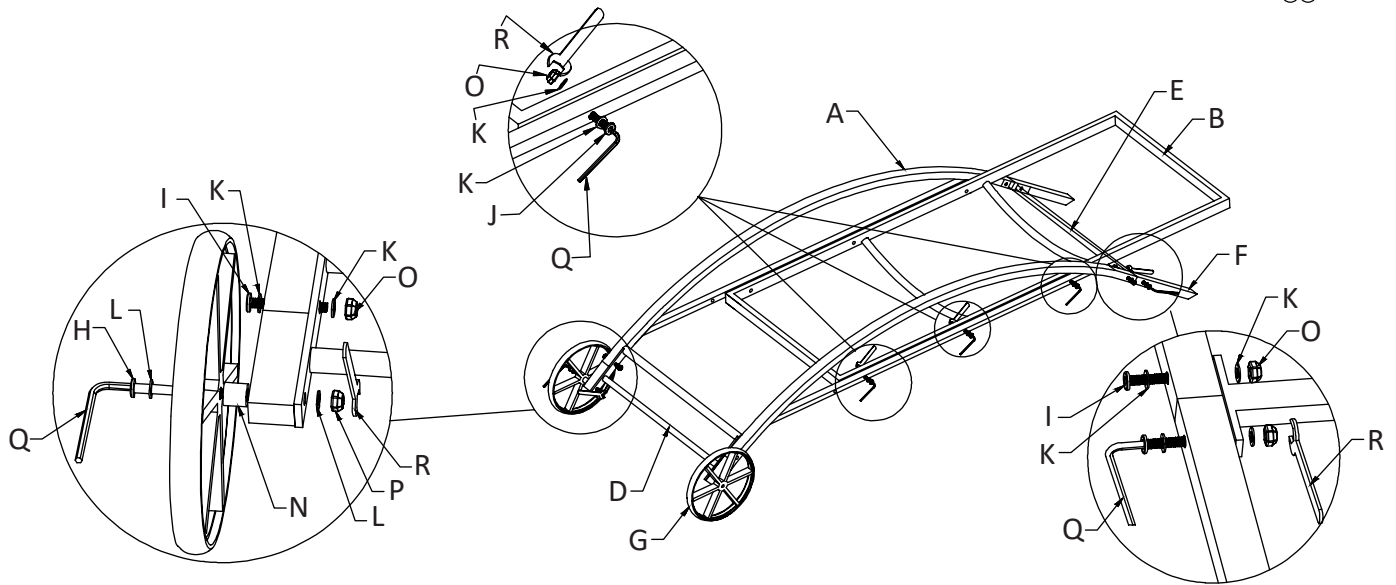
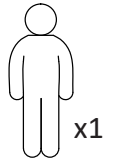
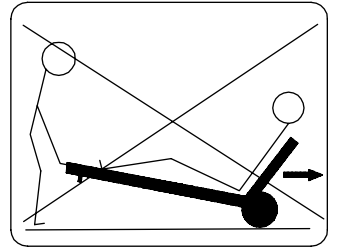
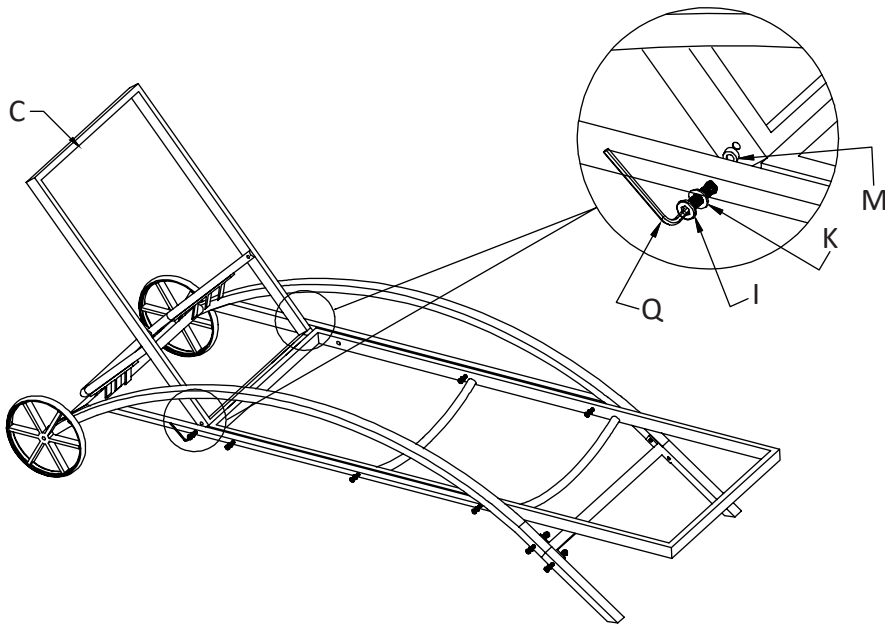

Ax1

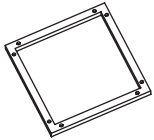

Bx4



Cx8



M6x20

Dx8



Ex1



1

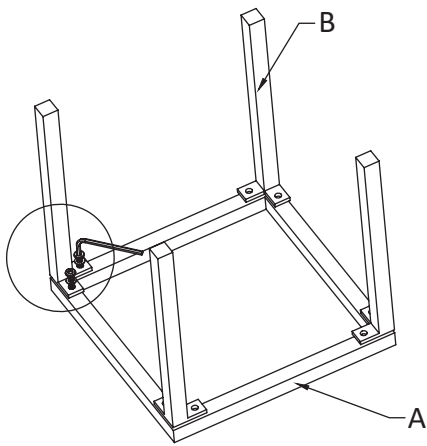

2

