

Floating Shelf Installation Instructions

Please check parts and read ALL instructions before you begin installation

Hardware Included

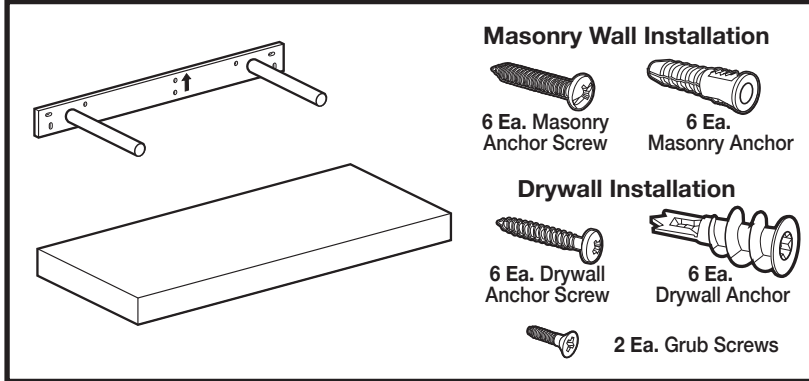

Tools Needed

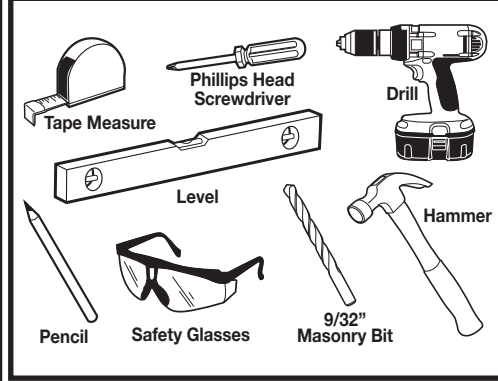

Capacity

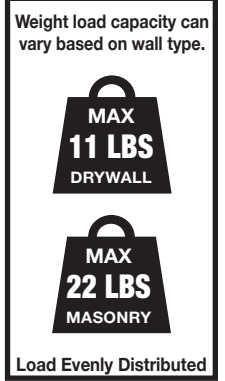

Installation Instructions

1. Determine the location of the shelf on your wall. To ensure proper installation, it is important to choose the correct fastener for your wall type (stud, masonry, drywall). If possible, try to locate wall studs. Make sure the Arrow on the bracket points UP. See Figure 1

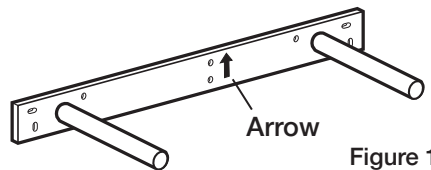

2. While holding shelf support against the wall, place a level on top of the shelf support. Level the support and mark holes on the wall with a pencil. See Figure 2

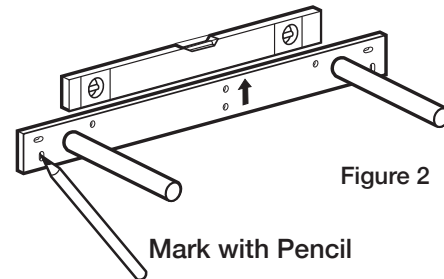

3. Masonry (Solid) Installation

Using a 9/32" masonry bit, drill a 1-1/2" deep hole. Tap wall anchor into hole (hammer may be required) until flush with wall surface. Position and install masonry anchor screws through bracket holes into the anchors to secure bracket to wall.

Drywall (Hollow) Installation

Using a phillips screwdriver, apply pressure to thread drywall anchor through drywall until it is flush with the surface of the wall. Position and install drywall anchor screws through bracket holes into the anchors to secure bracket to wall. (See Installation Tips)

Stud Installation

When installing into timber or studs, you can install without the need for drywall or masonry anchors. Pre-drilling a small hole first may allow for easier installation.

Note: Refer to Installation Tips for additional installation information. Also see Figure 3.

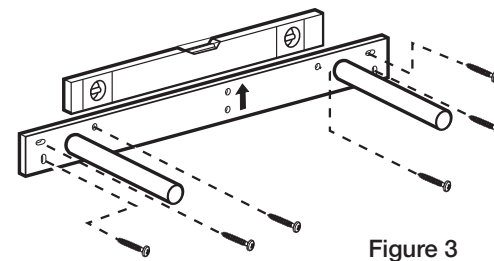

4. Slide the shelf onto the 2 bracket tubes. See Figure 4A.

Make sure the 2 holes on the shelf surface are on the underside. Fix the shelf to the bracket using the 2 countersunk head grub screws. Do not over tighten. See Figure 4B.

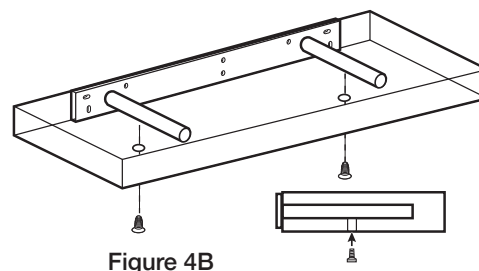
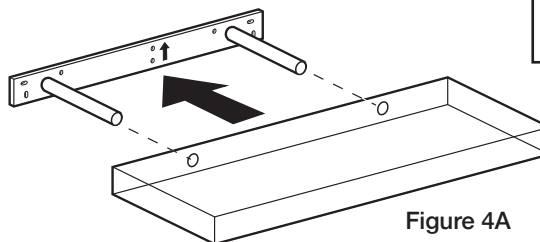

Wall Anchor Options

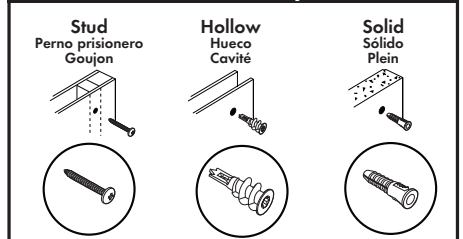

INSTALLATION TIPS

When mounting into drywall, if possible the bracket should be installed into at least one stud for added security. If holes in bracket do not align with location of wall studs, extra holes can be carefully drilled through the bracket to accommodate.

If mounting into drywall only, do not install anchors in both of the outer holes on each end of the bracket. In this situation, it is best to use only one upper or lower hole at each end, as securing both holes at one end can weaken the drywall at this location.

NOTE: When mounting into drywall, the anchors are only as strong as the wall they are mounted into. This could reduce the load capacity.

SAFETY:

For safety, the bracket tubes are angled slightly upward to prevent the shelf from drooping once installed and if shelf is loaded to capacity. Please note that floating shelves are designed for displaying items only and are not to be used for any other purpose.

DISCLAIMER: CAUTION

Install shelf and shelving units according to instructions provided. We and its related companies are not responsible for injury or damage resulting from incorrect installation or use. Products are for use only as shelves and shelving units and are not intended for any other purposes.