







For any missing or damaging parts, hardware, or any other problems, WELCOME to email us at:

[SERVICE@RILYSON.COM](mailto:SERVICE@RILYSON.COM) Or 1-888-733-8169 Toll free  
Monday-Friday 9AM - 5PM EST

\* Don't fully tighten all the bolts till the very end!

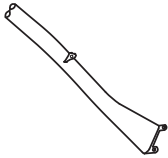
**PRE-ASSEMBLY PREPARATION:**

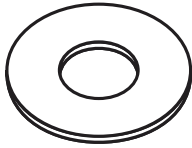
- Please read through the instructions before beginning assembly.
- Clear out the space for assembly and lay out all of the parts based on the Parts List, extra room will allow you to easily determine if all the pieces are present.
- Keep small parts and pieces away from children until fully assembled.

Part No.	Part	Qty	Image	Part No.	Part	Qty	Image
A	Top	1		B	Shelf	1	
C	Leg	4		D	Bolt	12	 M6 * 15MM
E	Wahser	12		F	Hex Wrench	1	

### STEP 1

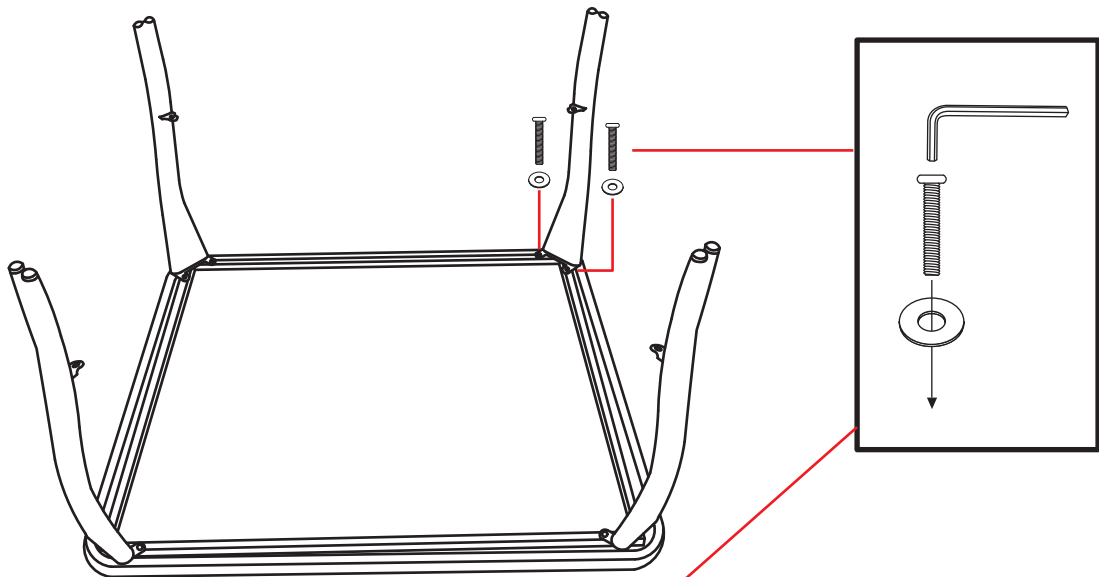

### STEP 2

