

WARNING !!

Furniture Tipping Risk

Serious risk of severe or fatal crush injuries can occur from furniture tipping over if not secured.

Children like to climb on furniture and Unsecured furniture can pose a Serious danger.

Please follow all instructions and install the tip - over restraints provided.

In addition to installing the restraints to help prevent tip - over:

1. Place heaviest items in the lowest drawers.
2. Unless Specifically designed to the accommodate do not set tv's or other heavy objects on top of this product.
3. Never allow children to climb or hang on drawers, doors, or shelves.
4. Do not leave drawers open.
5. Never open more than one drawer at a time, and.
6. Do not step on the base.

Instruction of Cabinet Restraint Device (CRD)

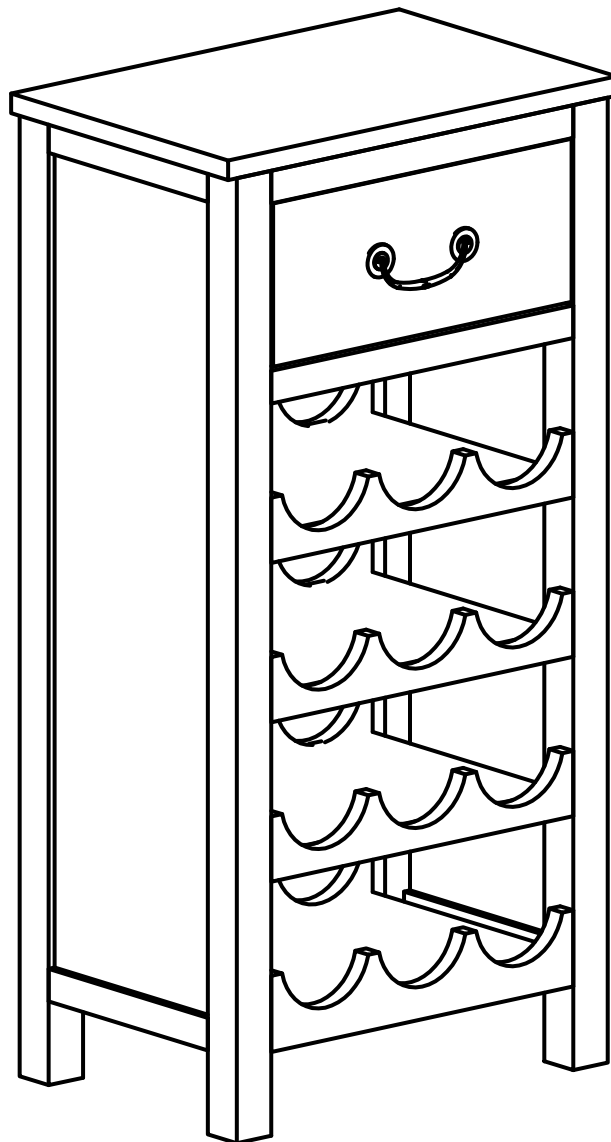

Caution: You must read this before you process

Cabinet

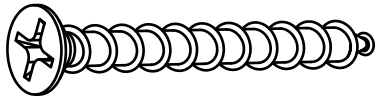
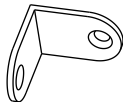

**CAUTION : This Cabinet is NOT a TOY.
Keep your child / children at bay during the assembly process.
For moving the Cabinet and to prevent damage to the Cabinet, two people
may be needed to execute this action.**

Hardware

Label	Picture	Description	QTY
①		Screw (M4x20mm)	2
②		Screw (M4x50mm)	2
③		Metal Bracket	4
④		Cabinet Restraint Strap	2



WARNING

Serious or fatal crushing injuries can occur from tipping furniture. To help prevent tip-over: ALWAYS secure this furniture to the wall using Cabinet Restraint Device. See product instructions for more ways to help prevent furniture tip-over.

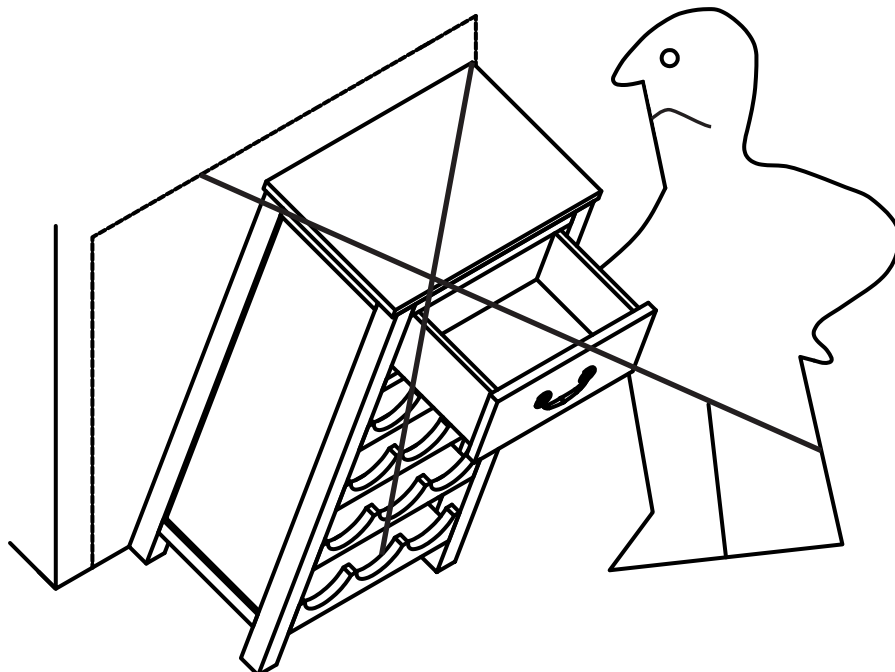

Usage For Cabinet Restraint Device :

For Cabinet against wall, fix 2pcs Metal Brackets(③) on wall and 2pcs Metal Brackets(③) on product, use Cabinet Restraint Strap(④) to connect the Metal Bracket(③) on wall and product. Find details as below:

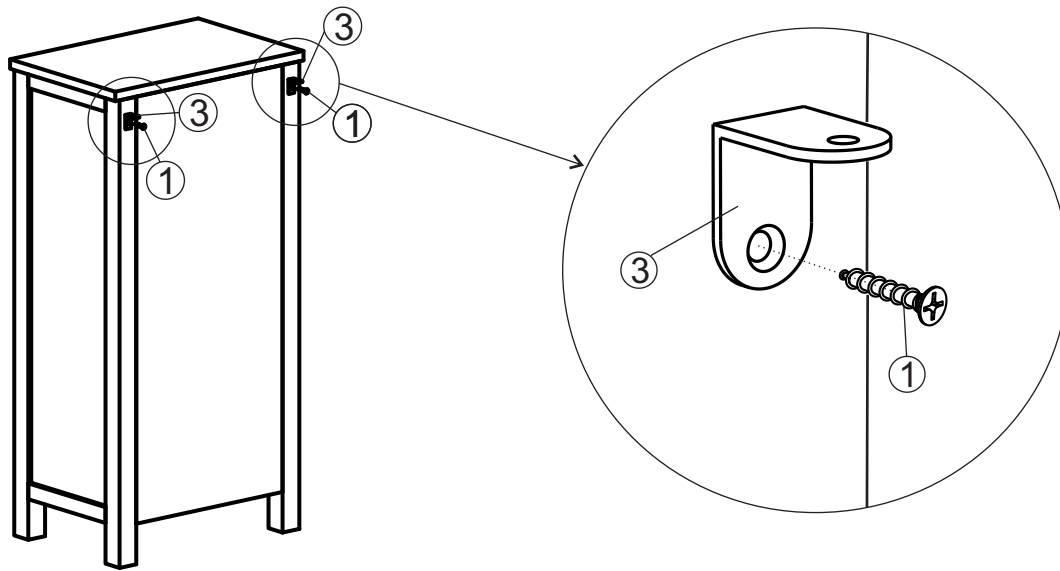

A: Firstly, turn back the Cabinet outwards as shown above.
 Then fix one Metal Bracket (③) on the leg of Cabinet by the 20mm (0.75 inch) Self Tapping Screws (①) .
 The distance between the left edge of the leg and bracket is 0.3 inch.
 The distance between the right edge of the leg and bracket is 0.3 inch.
 Repeat this step to fix another Metal Bracket (③) on product, as shown above.

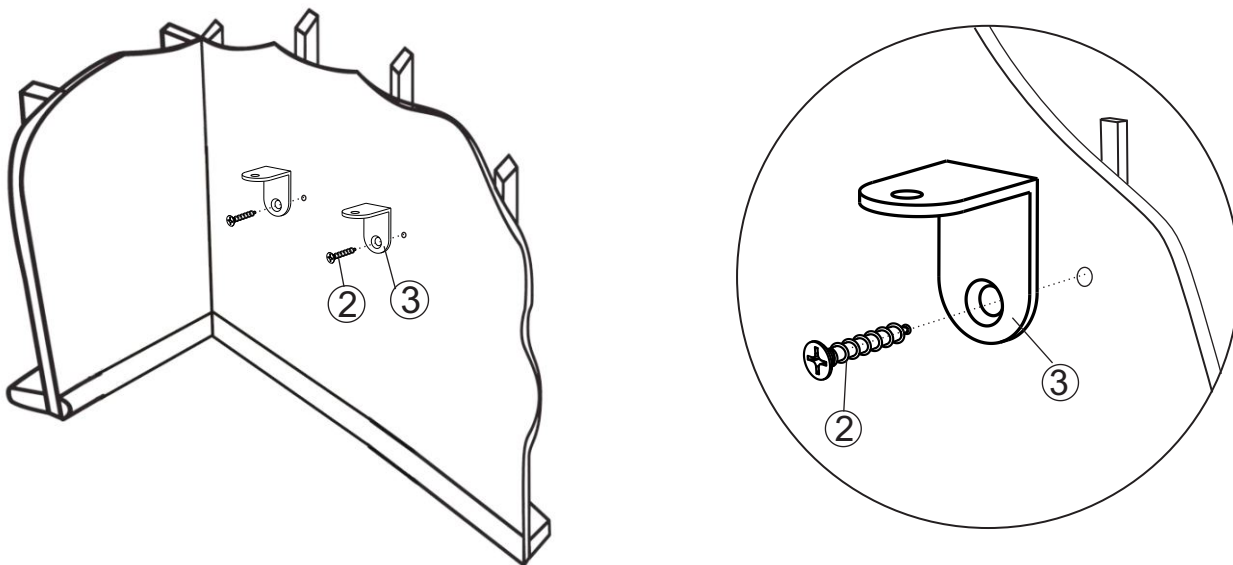



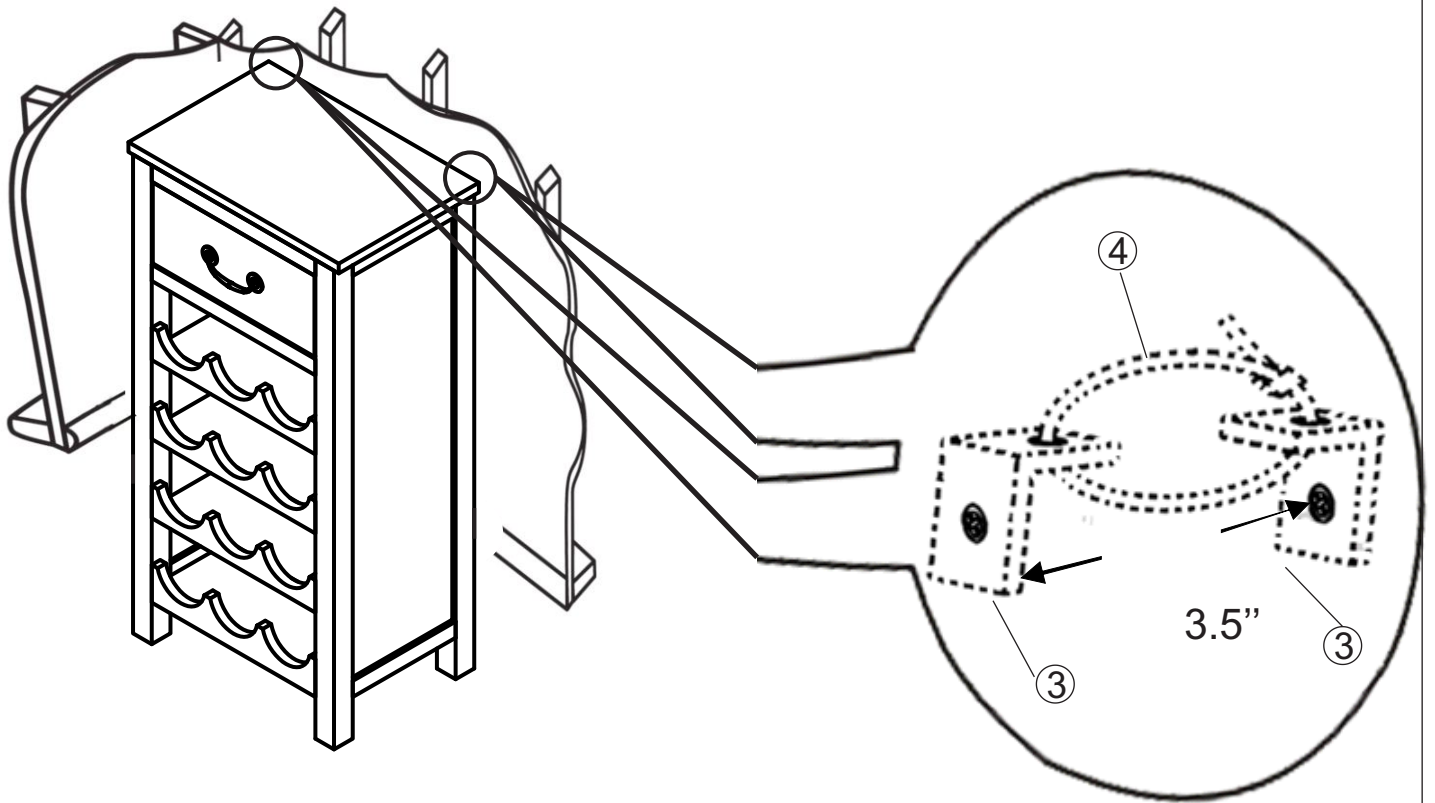



























B: Find out the screw holes on the wall.
 First, mark the point at same height on the wall as Metal Bracket (③) on product.
 You can find these same points in two ways as below:
 1. Move the Cabinet back to the wall, make these points on the wall and product are at same height.
 2. Measure the height of the Metal Bracket and the wall by ruler, keep them are accurately and same height.
(Caution: The Cabinet Restraint Strap (④) between Metal Brackets on product and wall should be within 3.5 inch).
 Then fix one Metal Bracket (③) on the mark on wall by the 50mm (2 inch) Self Tapping Screws(②). Repeat this step to fix another Metal Bracket (③) on wall, as shown above.



C: Move the Cabinet against the wall. Then pull the Cabinet Restraint Strap (④) through two Metal Brackets (③) one by one, lock tight the Cabinet Restraint Strap (④) as shown above.

Cabinet Restraint Device is installed and Cabinet is ready for use.

Care & Maintenance

-    Do not put hot items directly on furniture surface
 -    Do not clean furniture with harsh cleansers or polish.
 -    Do not place furniture under direct sunlight.
 -    Do not place furniture near heating or cooling vents.
 -    Do not write on furniture without a padded barrier to protect the surface.
 -    Do not place furniture outside . For indoor use only .
 -    Not for commercial use. For residential use only .
 -    Stains may be removed with mild soap solution and damp cloth.
 -    Children should not climb or jump on the furniture.
-
-    Dust and pick- up spills using a clean, non- colored, lint- free cloth .