

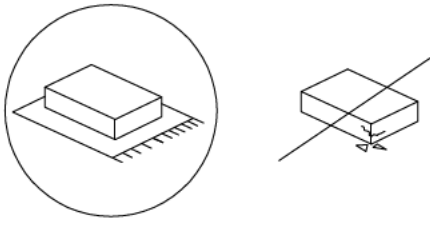

		60'
		
		2



1

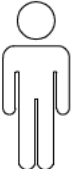
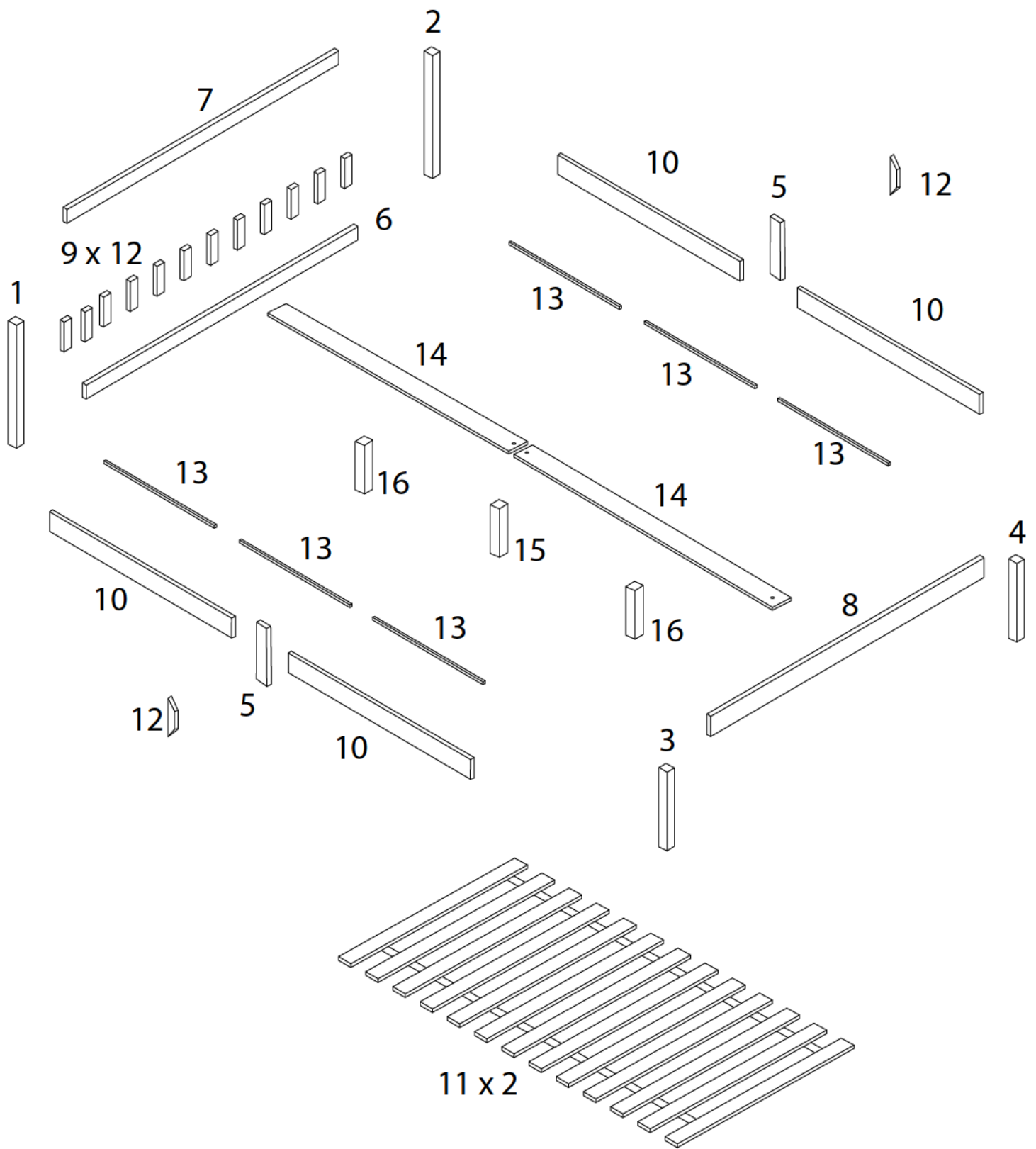

x 1

2



x 1

3



x 1

4



x 1

5



x 2

6

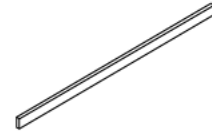

x 1

7

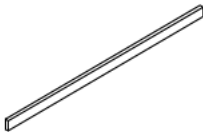

x 1

8

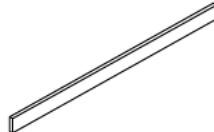

x 1

9



x 12

10

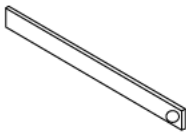

x 1

11

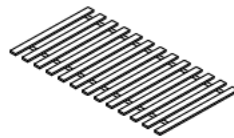

x 2

12



x 2

13



x 6

14

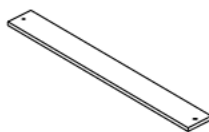

x 2

15



x 1

16



x 2

M

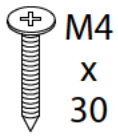

x 94

N

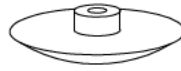

x 14

P

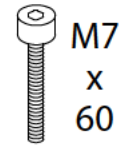

x 6

Q

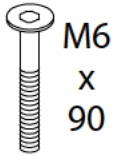

x 12

R



x 12

S



x 74

T



x 2

U

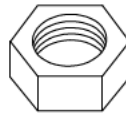

x 4

V

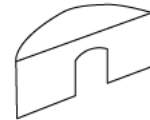

x 4

W



x 4

X

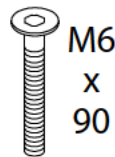

x 2

Y

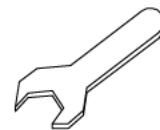

x 1

Z

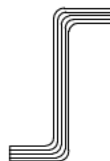

x 1

1 x 12

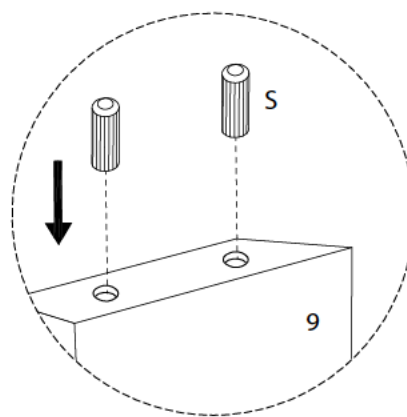
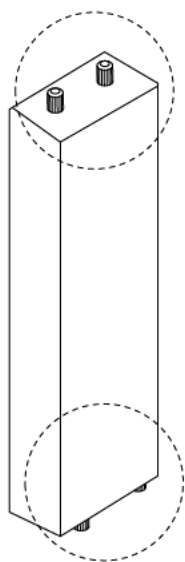
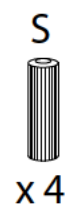
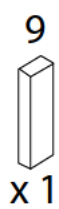

2

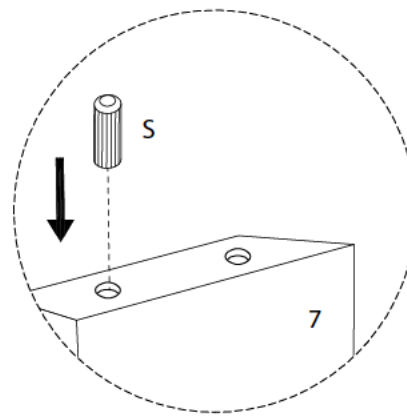
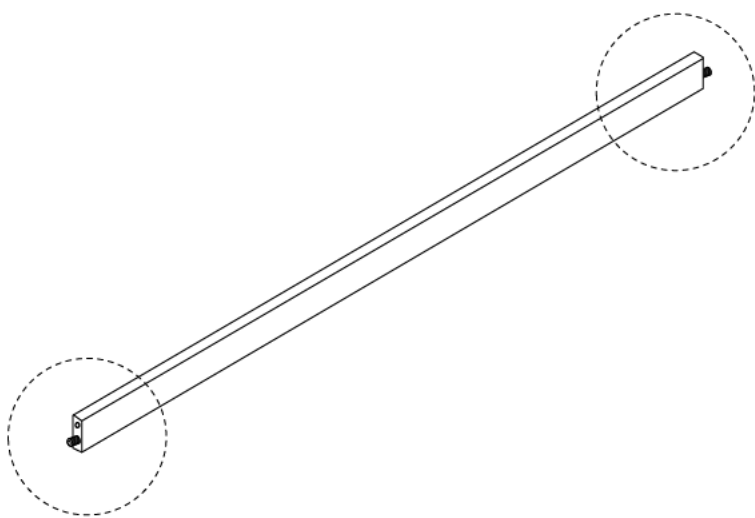
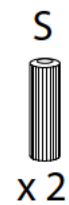
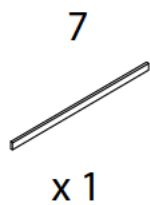

3

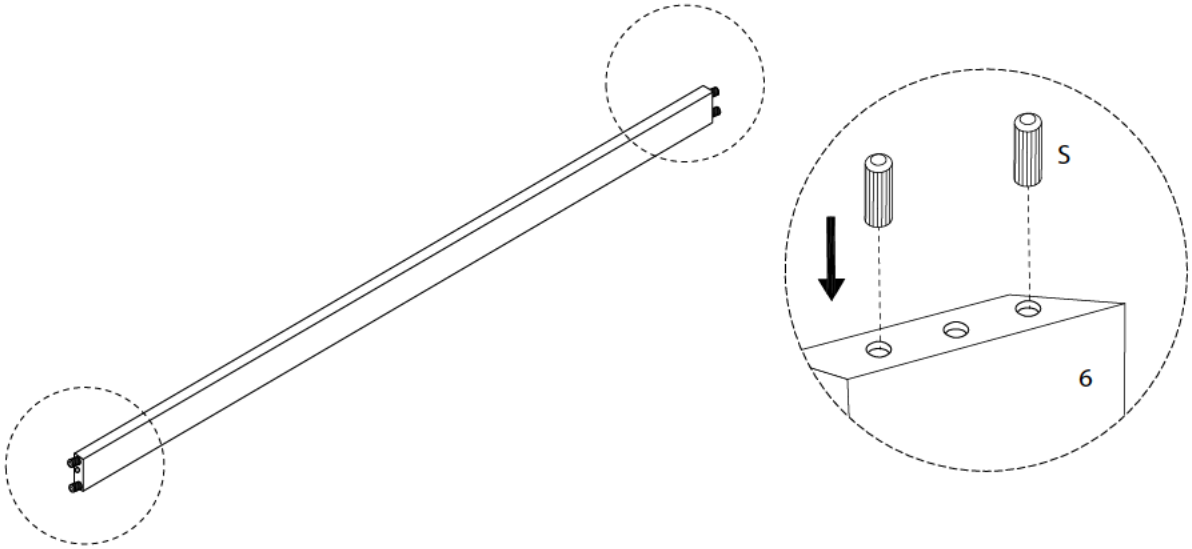
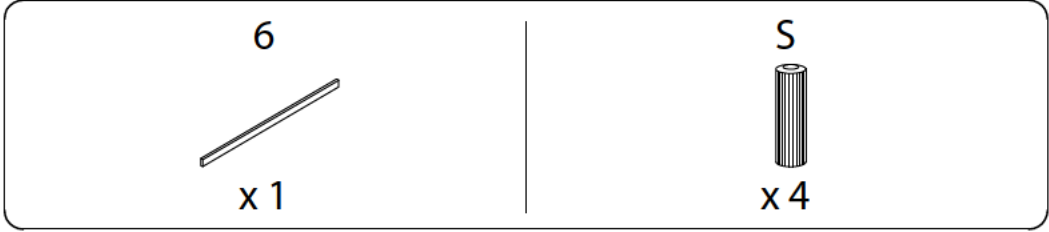

4

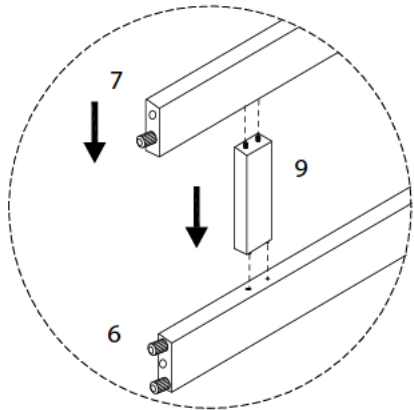
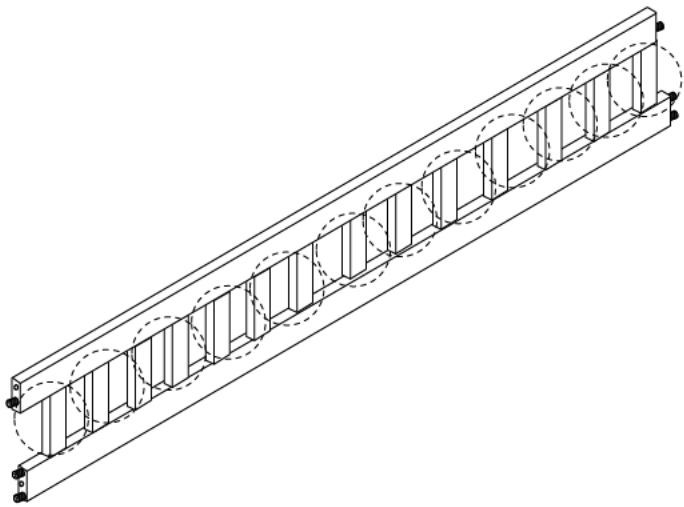

5

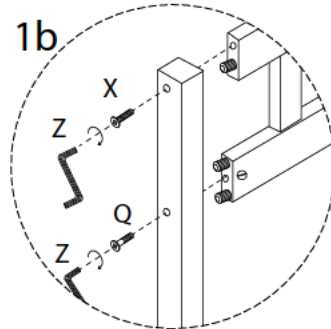
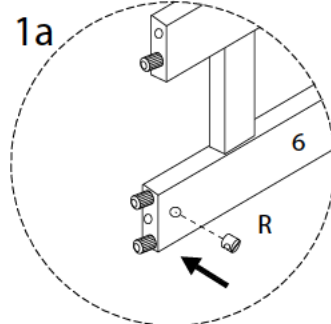
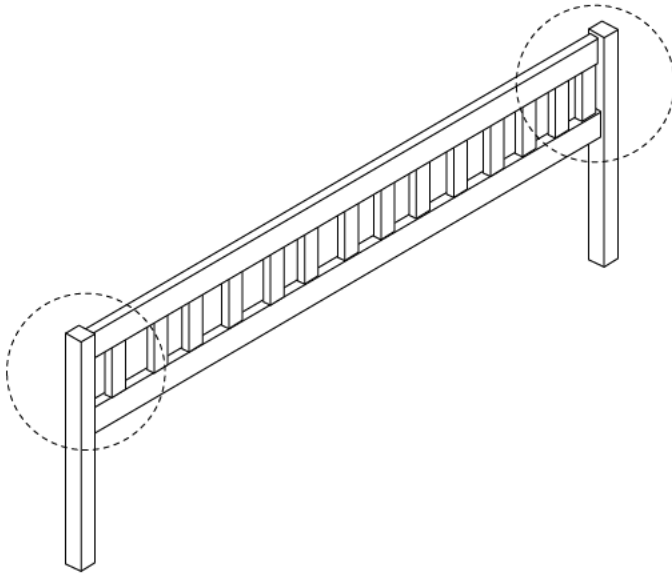
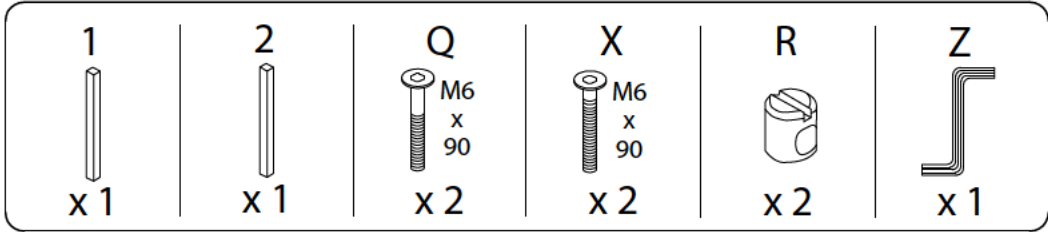

6

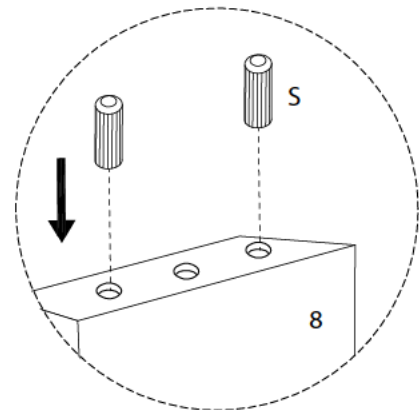
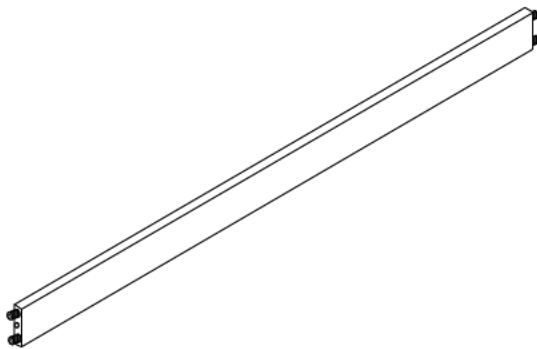
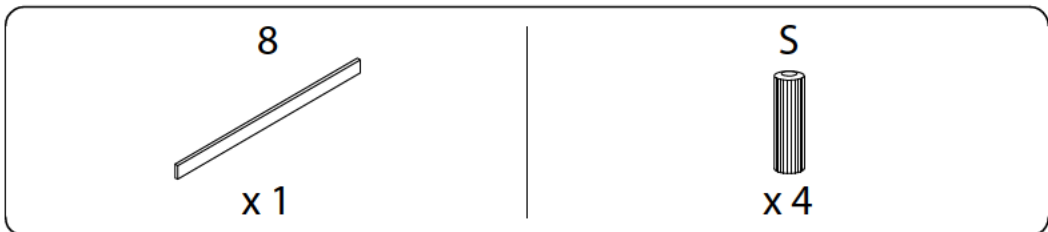

7

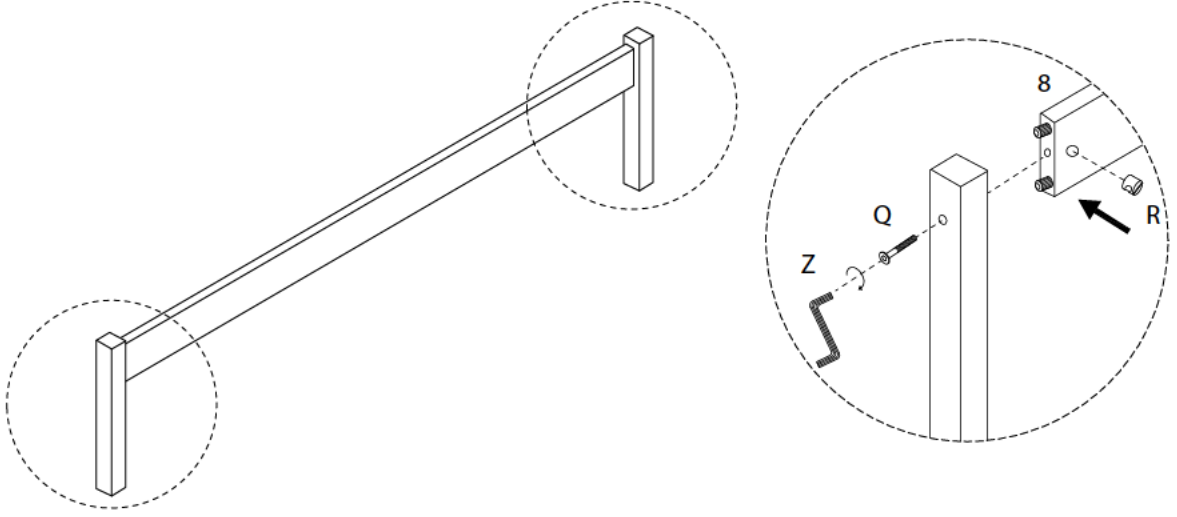
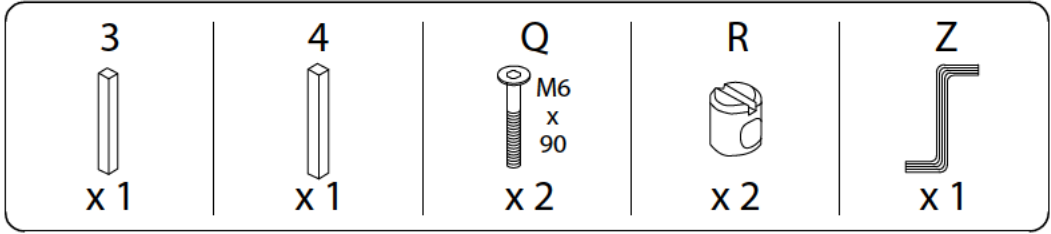

8 x 4

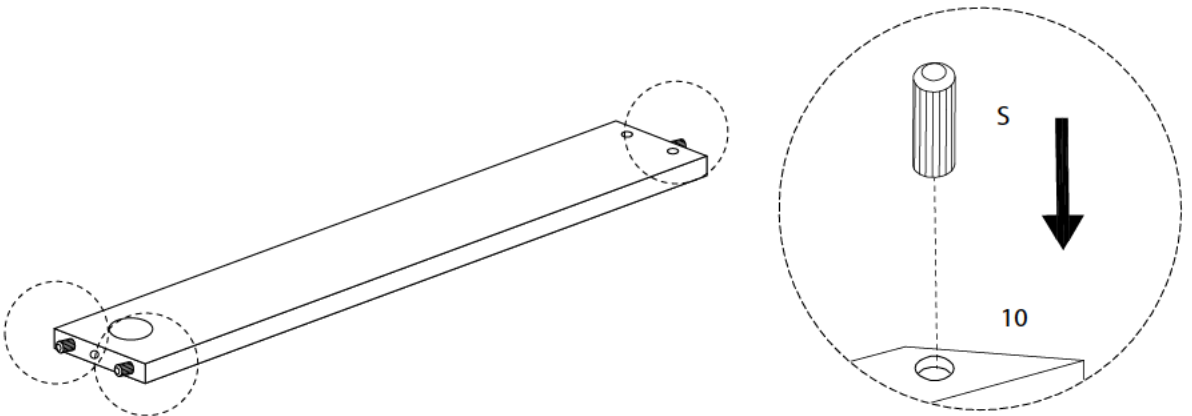
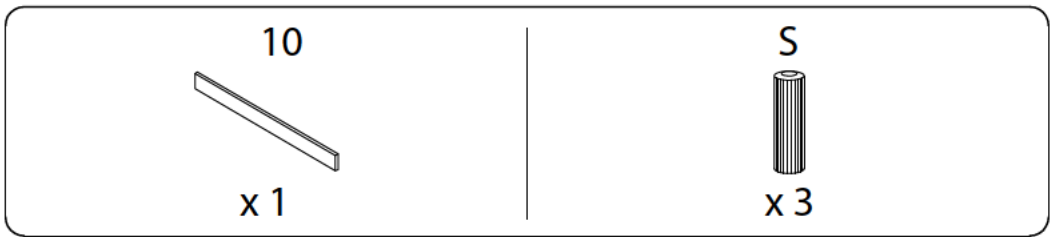

9 x 2

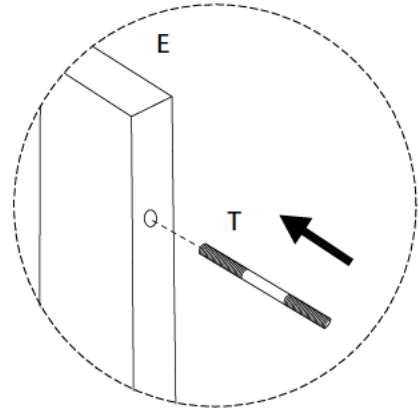
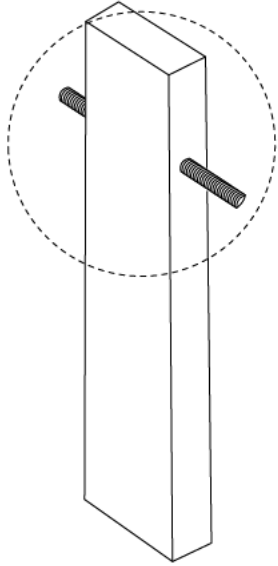

10 x 2

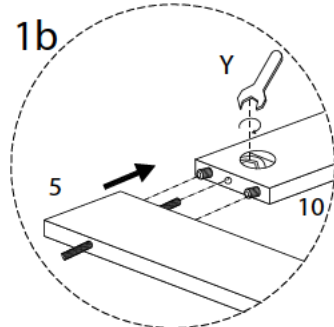
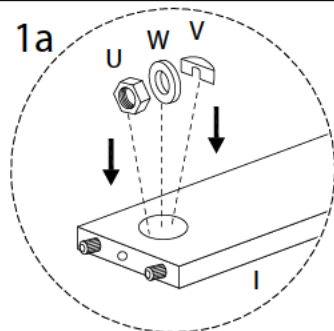
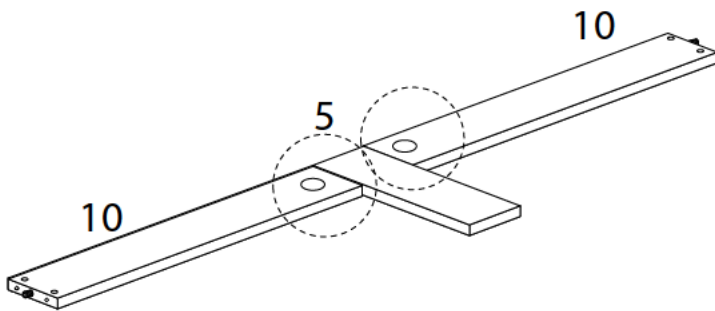
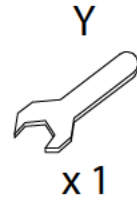
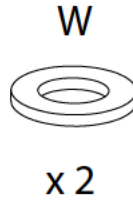
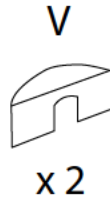
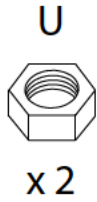



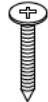

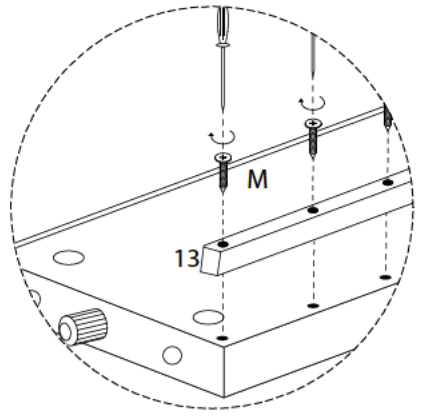
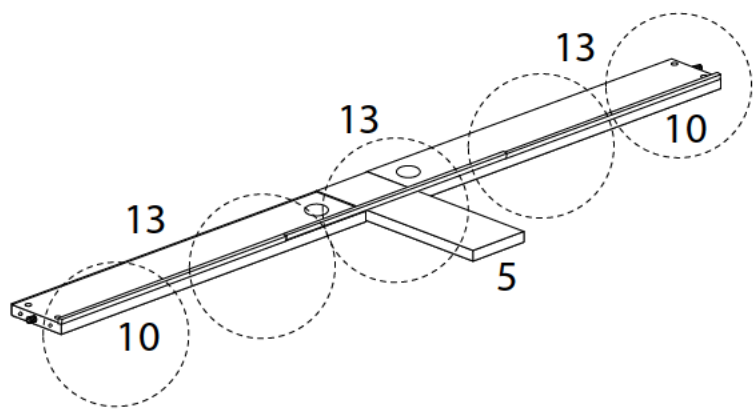
11 x 2

13  x 3	M  M4 x 30 x 15
--	---

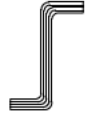

12

14  x 2	15  x 1	16  x 2	P  M7 x 60 x 4	Z  x 1
--	--	--	--	---

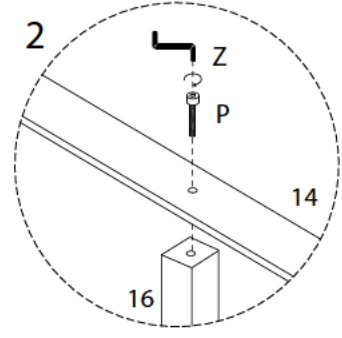
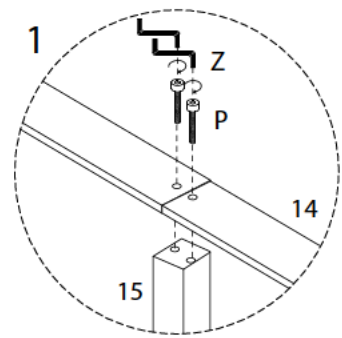
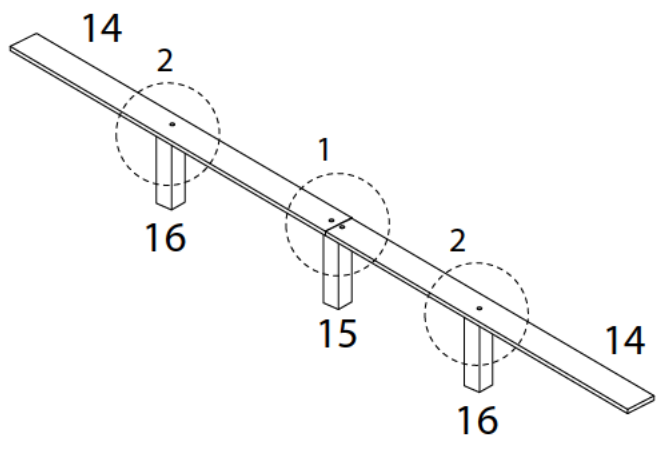

13

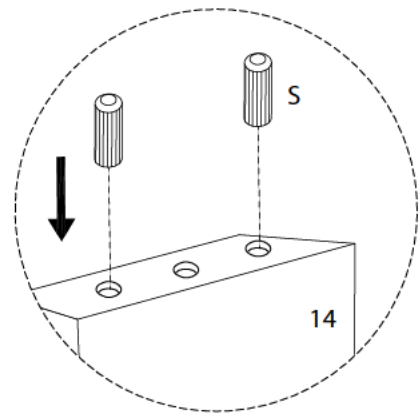
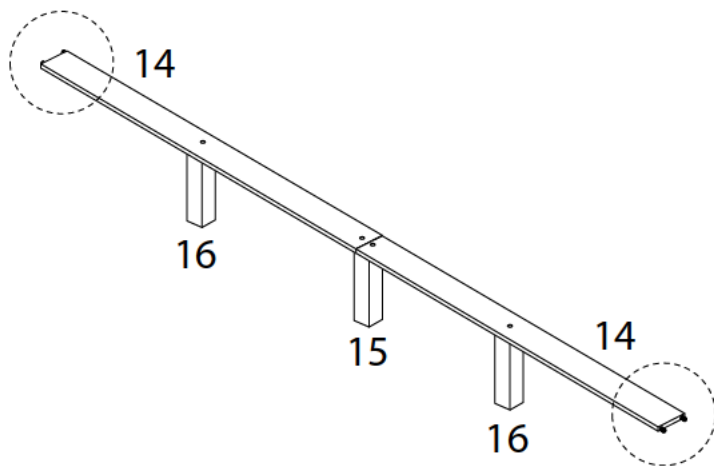
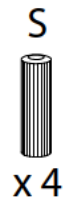

14

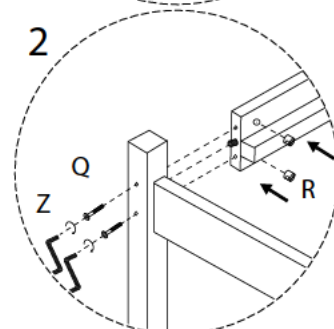
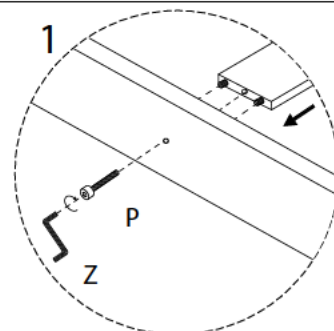
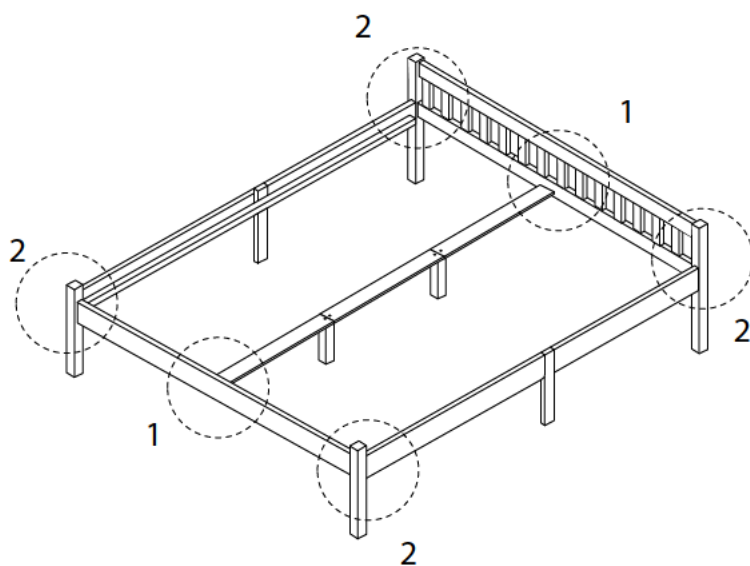
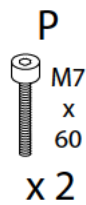
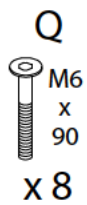

15

M
M4
x
30
x 60

11
x 2

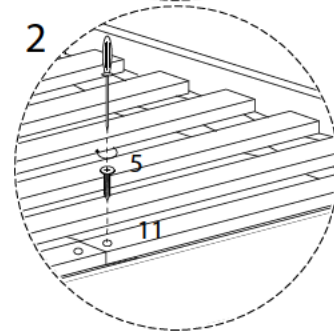
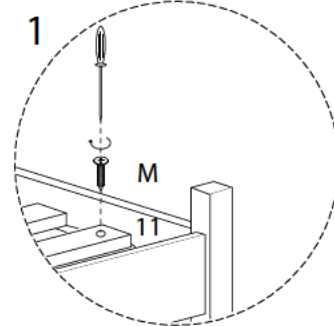
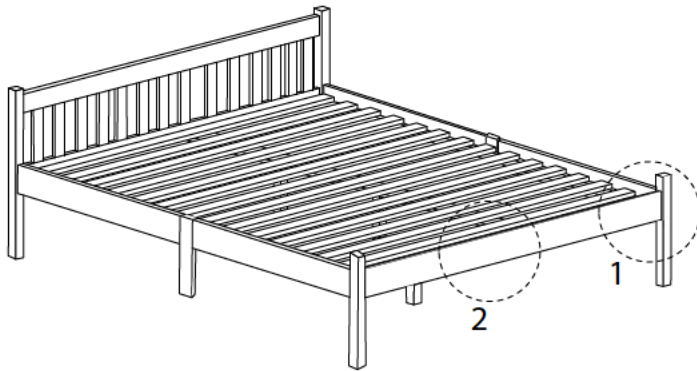

16

M
M4
x
30
x 4

12
x 2

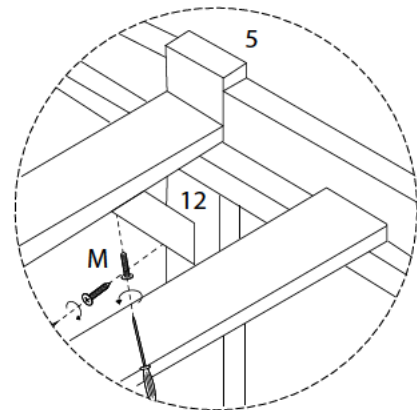
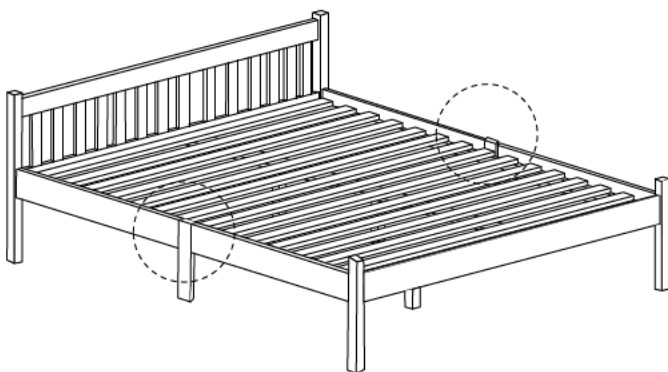

17

N

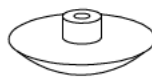

x 14

