

# WYNDHAM COLLECTION

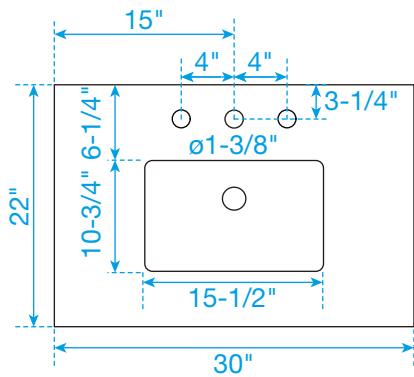

TOP VIEW OF VANITY CABINET

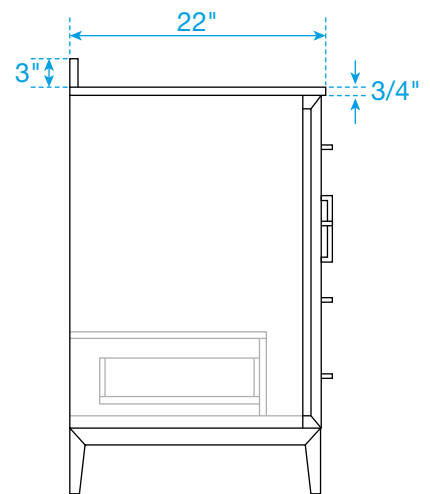
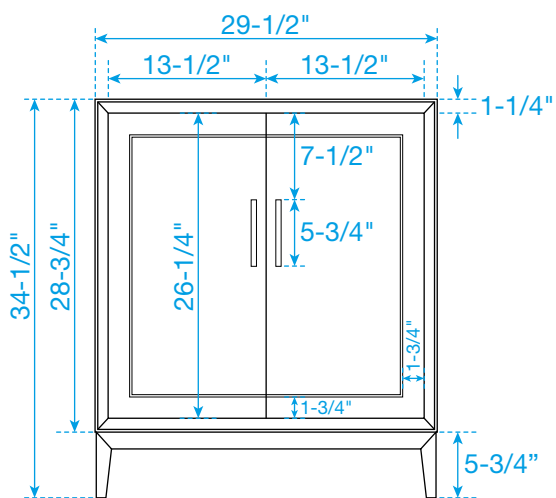
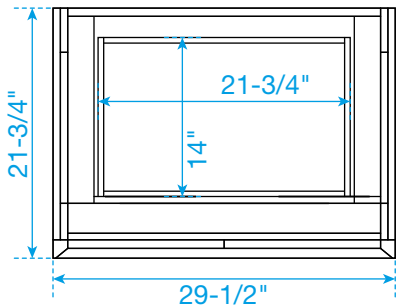
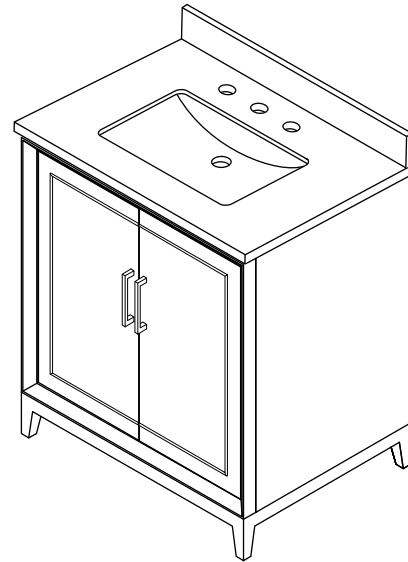

\*Note: All measurements are  $\pm 1/4$ ".

WC-5151-30-SGL-VCA3

# WYNDHAM COLLECTION

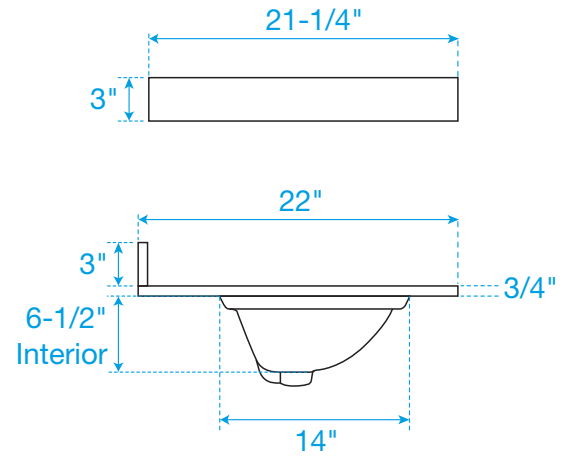
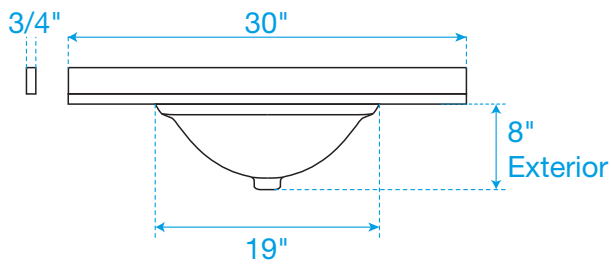
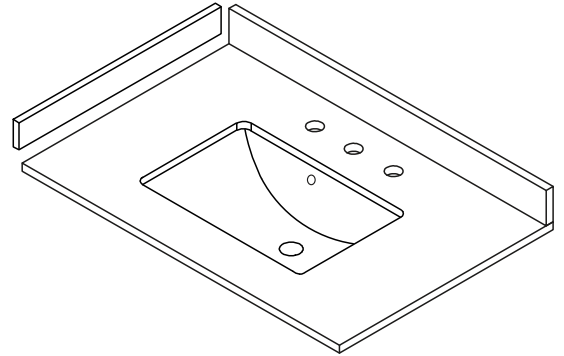
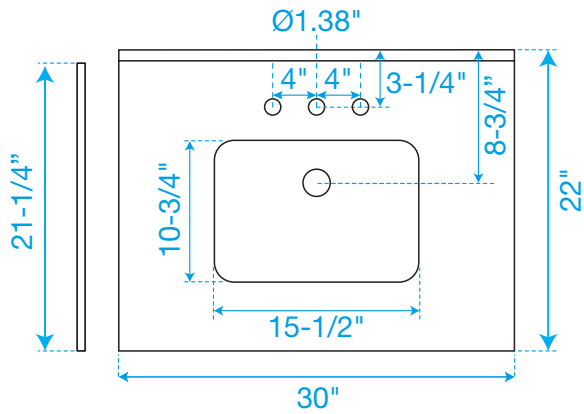

Side splash is reversible.  
Note: All measurements are  $\pm 1/4"$ .

WC-VCA3-30-SGL-TOP