

LOVESEAT COUCH

Assembly Instructions

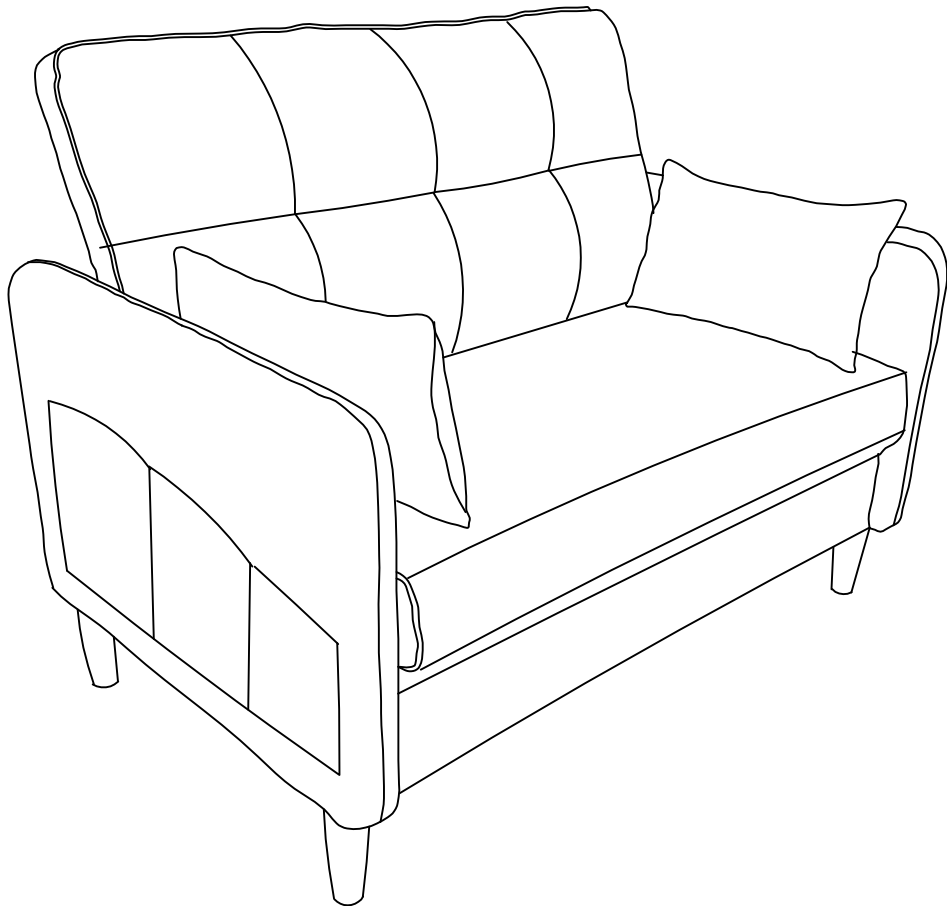





Note:

1. Please confirm all parts correct before assemble
2. If you have any questions, please feel free to contact us:

Email: Sofa_Service@outlook.com

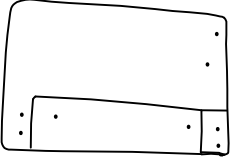
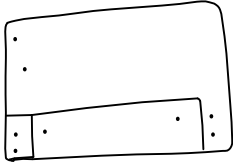
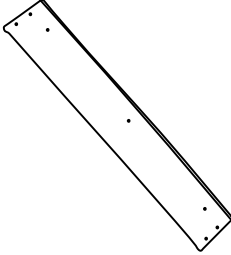
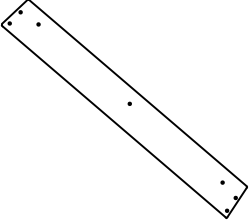
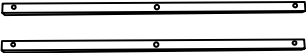
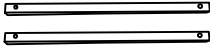
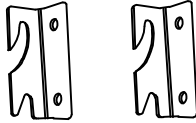
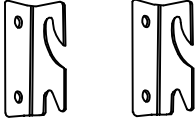
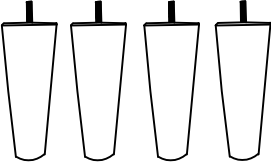
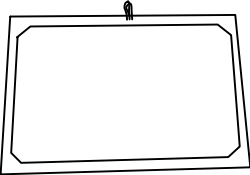
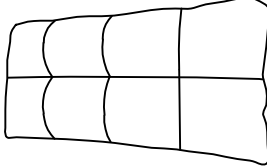
Phone number: +18775897780

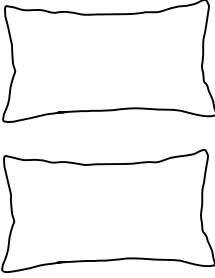
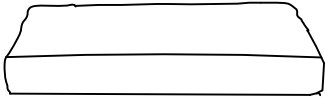
PART LIST

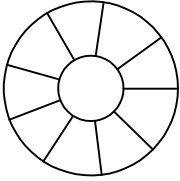
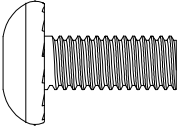
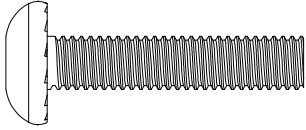
AL 	AR 	B 	C 
Left armrest(1PC)	Right armrest(1PC)	Front plate(1PC)	Backplate(1PC)
D 	E 	F1 	F2 
Rod(2PCS)	Rod(2PCS)	Accessories(2PCS)	Accessories(2PCS)
G 	H 	I 	J 
Foot (4PCS)	Frame (1PC)	Back cushion(1PC)	Backrest(1PC)
K 	L 	M 	N 
Throw Pillow(2PCS)	Seat Cushion(1PC)	Allen Key M6(1PC)	Gasket (30PCS)
O 	P 	Q 	
Plastic Gaskets4(PCS)	Screw M6*16 (8PCS)	Screw M6*35(18PCS)	

R

Note: The screws are in 1:1 ratio and can be placed here for comparison.

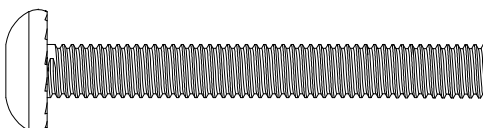

Screw M6*60(4PCS)

DISASSEMBLY DIAGRAM

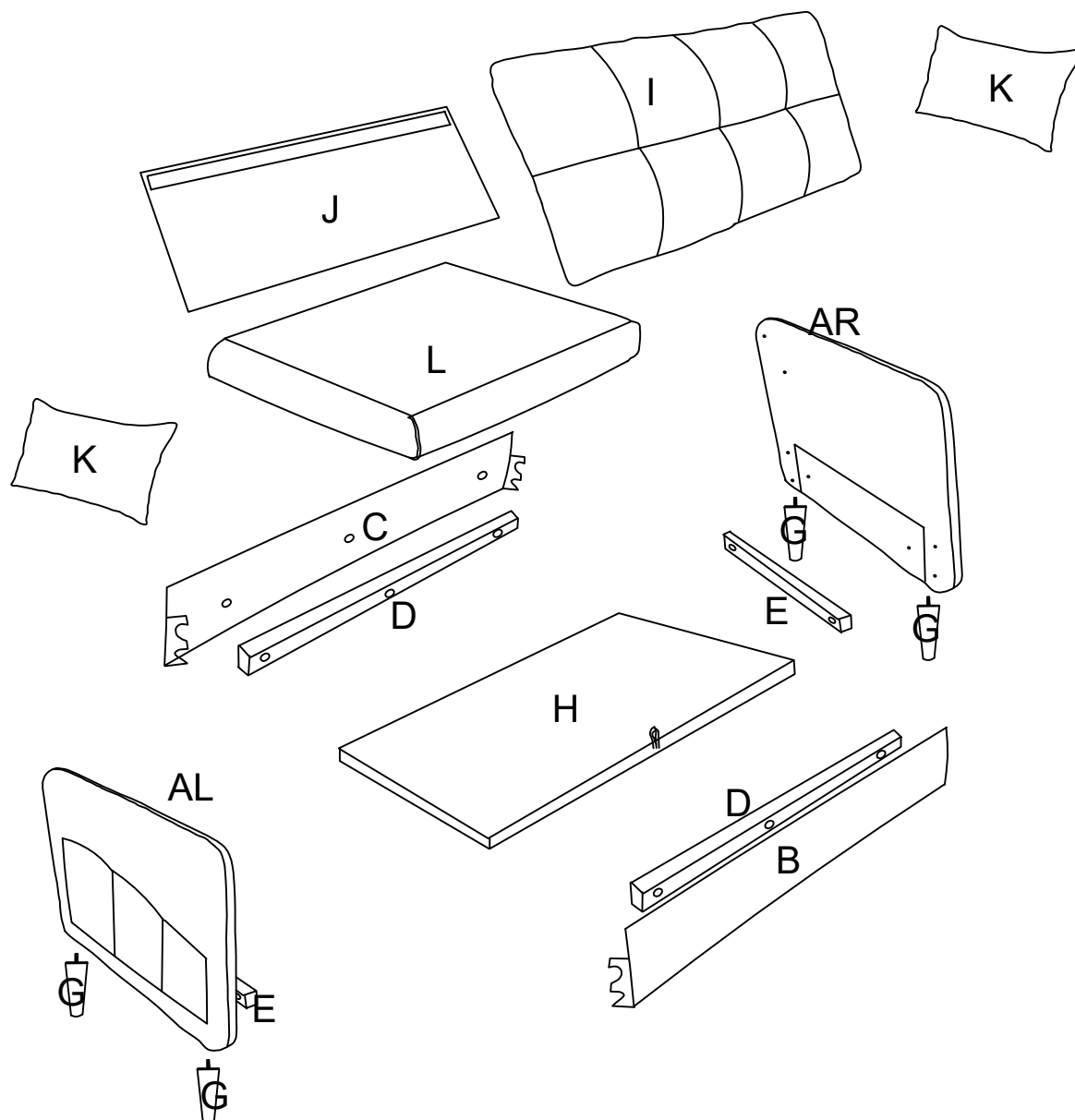

STEP 1 Screw the sofa feet G with plastic spacers O into the sofa arms (AL/AR).

AL		1
AR		1
G		4
O		4

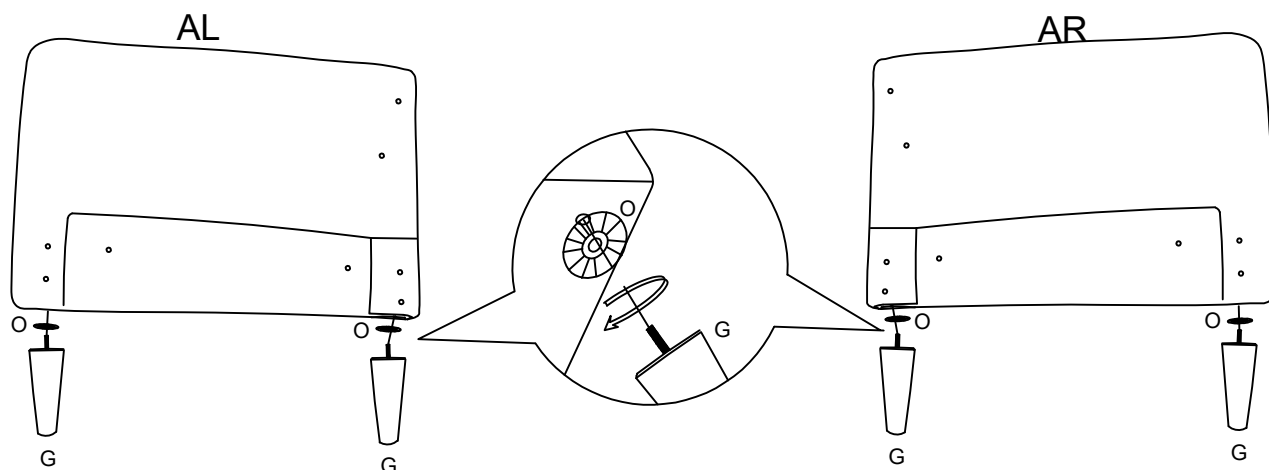

STEP 2

First align the rod E with the holes in the armrests then screw the screws Q and spacers N into the armrests of the sofa using a Allen Key.

AL		1
AR		1
E		2
Q		4
N		4
M		1

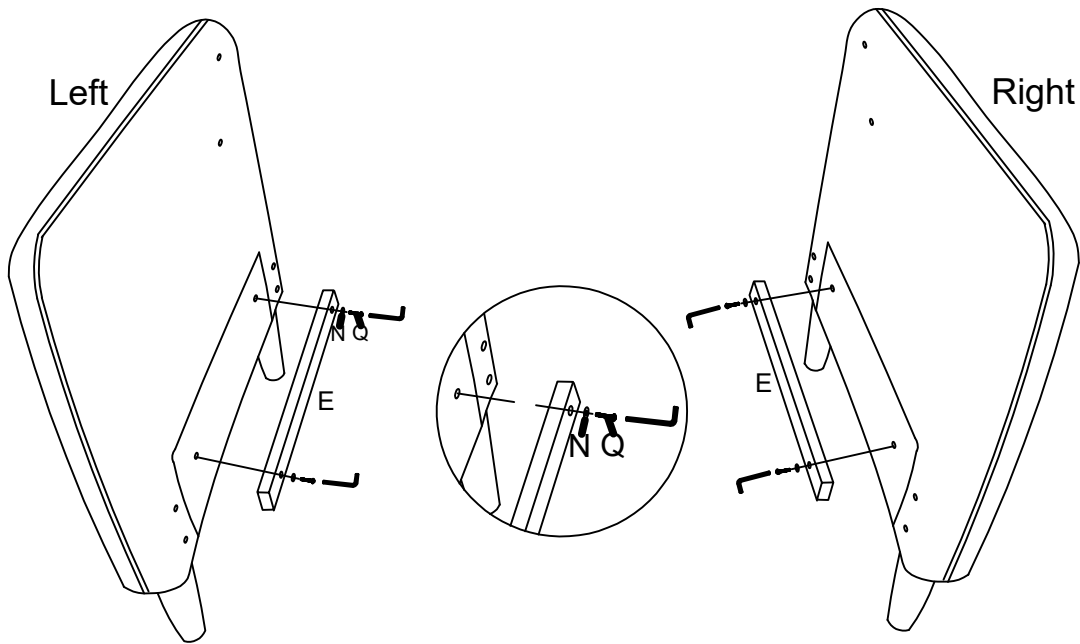

STEP 3

Screw the screws Q and spacers N into the armrests of the sofa with a Allen Key one third of the way in.

AL		1
AR		1
Q		8
N		8
M		1

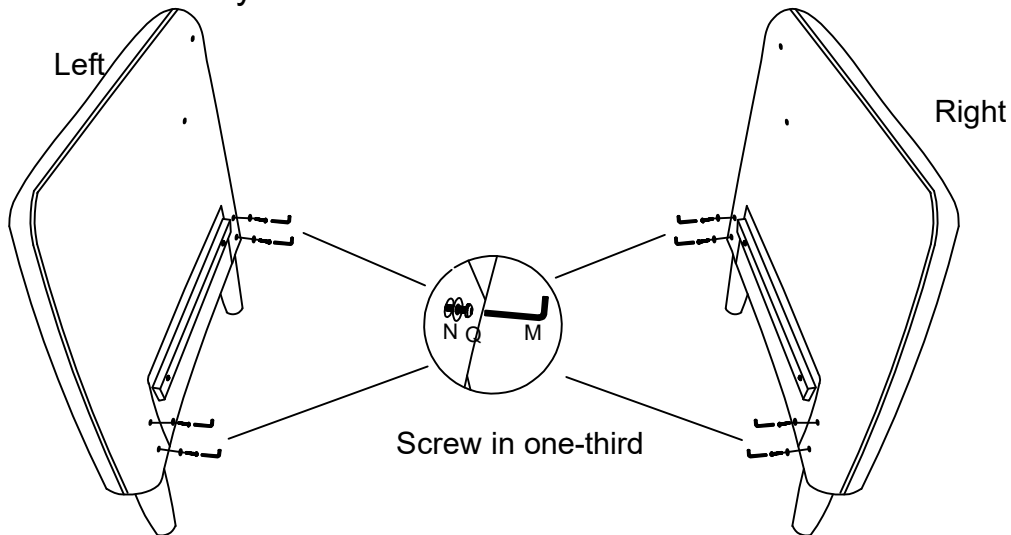





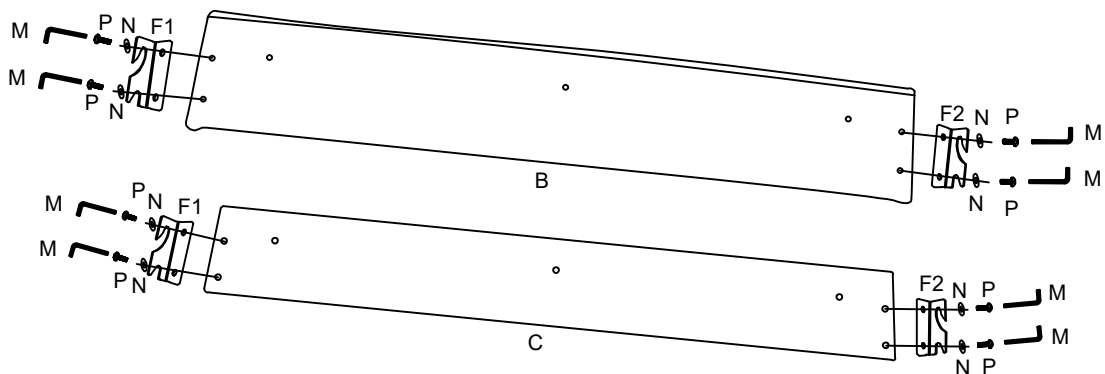

STEP 4

As shown in the figure, first align the connecting iron piece F1/F2 with the holes plate B/plate C. Tighten the spacer N and screw P with a Allen Key.

F1		2
F2		2
B		1
C		1
P		8
N		8
M		1



STEP5

B		1
C		1
D		2
N		6
Q		6
M		1

First align the rod D with the holes in the front plate B/rear plate C, then tighten the screws Q and spacers N with a Allen Key.

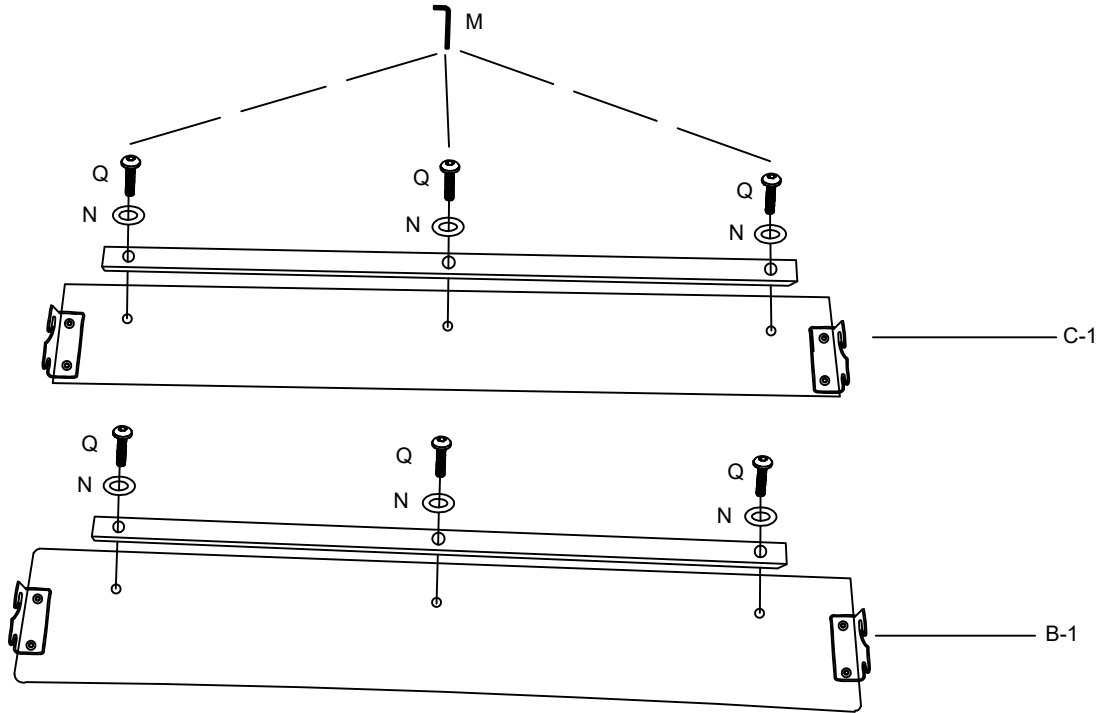

STEP6 Snap the completed assembled C-1 from step 5 onto the handrail locking into one third of the screws as shown, and lock it in place.

C-1		1
-----	--	---

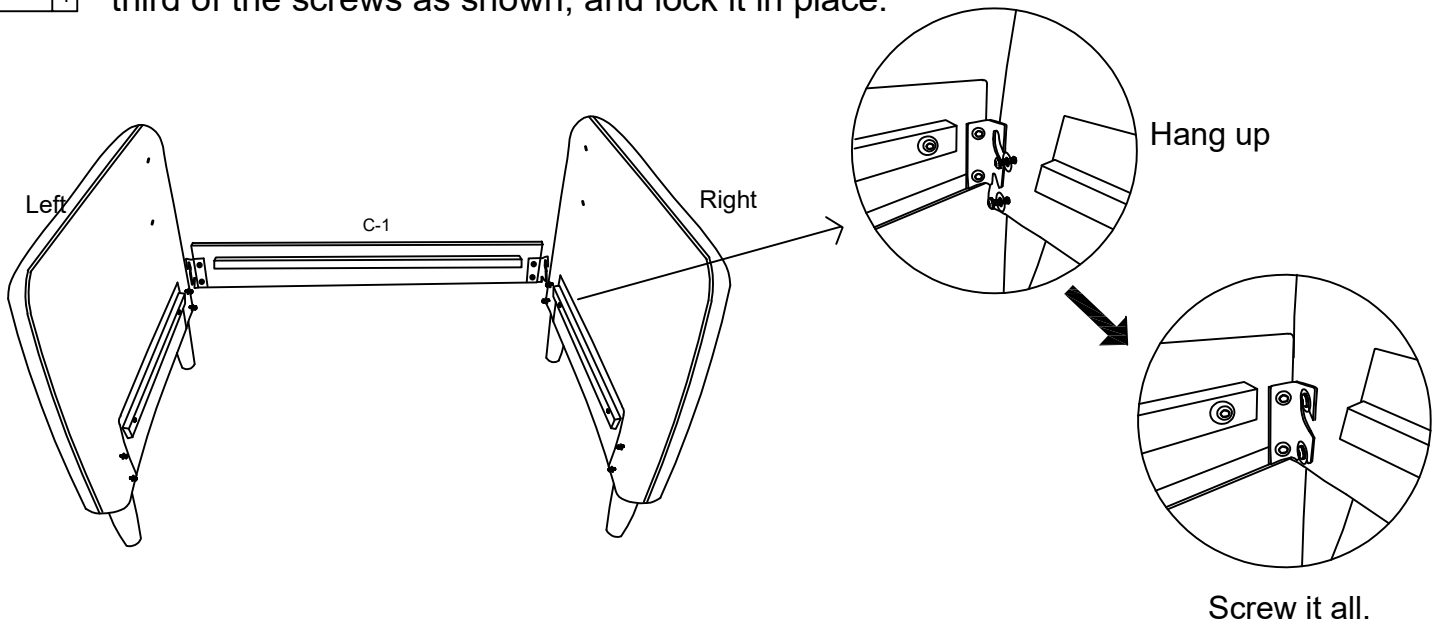



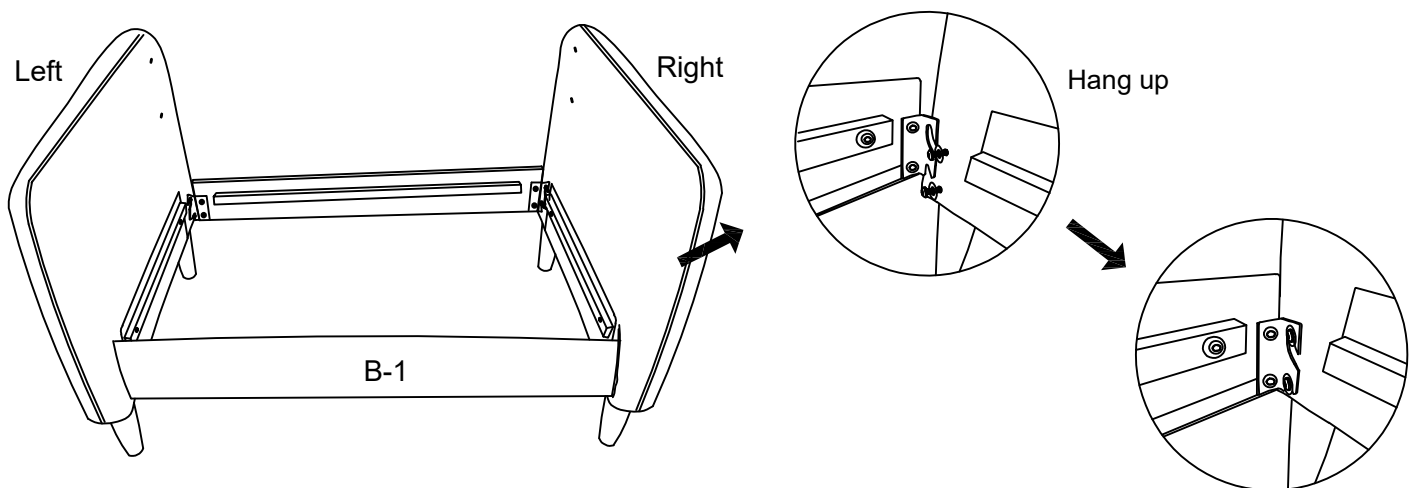

STEP7 Snap the completed assembled B-1 from step 5 onto the handrail locking into one third of the screws as shown, and lock it in place.

B-1		1
-----	--	---



STEP 8

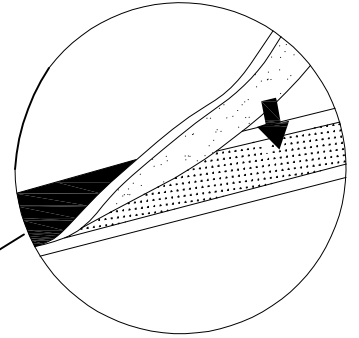
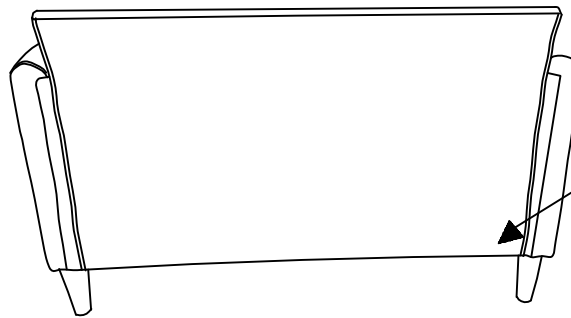
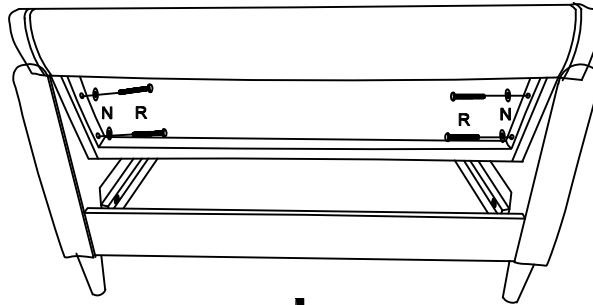
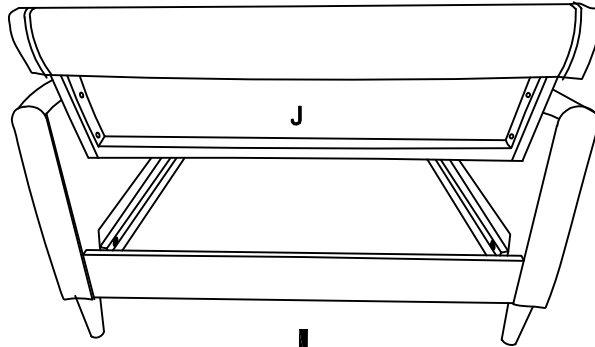

First, weave the backrest fabric forward, align the backrest with the armrest holes, lock it with screws R, and then pull down the fabric to attach the felt.

J		1
R		4
N		4
M		1



STEP 9

Use the cutting tool to open the compression bag and remove the back cushion I, throw pillows K and seat cushion L. Adjust to the original shape by hand.

I		1
K		2
L		1

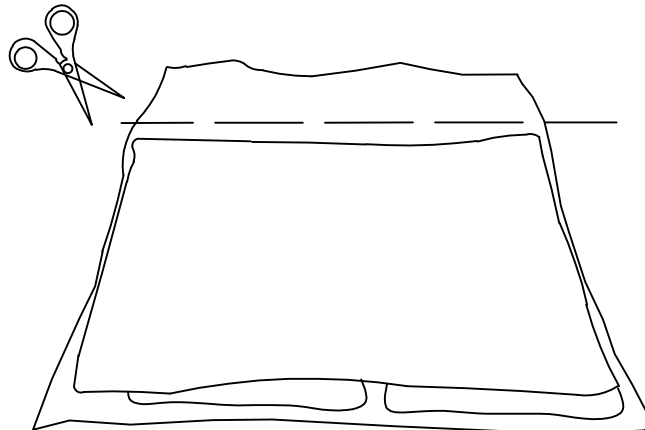

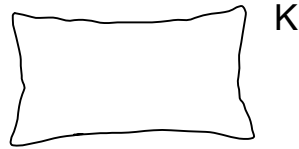
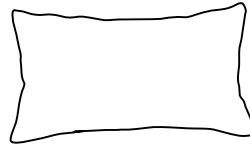
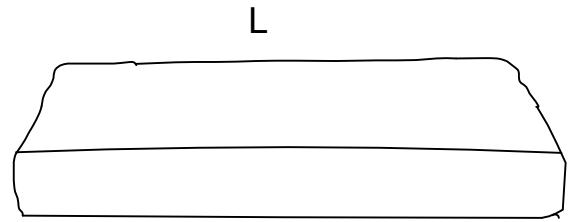
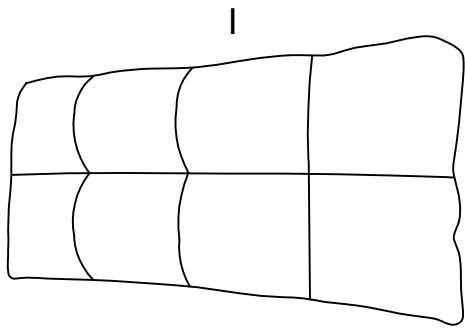

STEP 10 Into the seat frame H

H		1
---	--	---

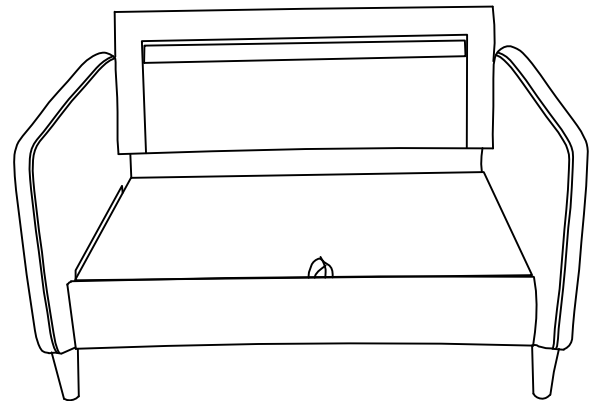
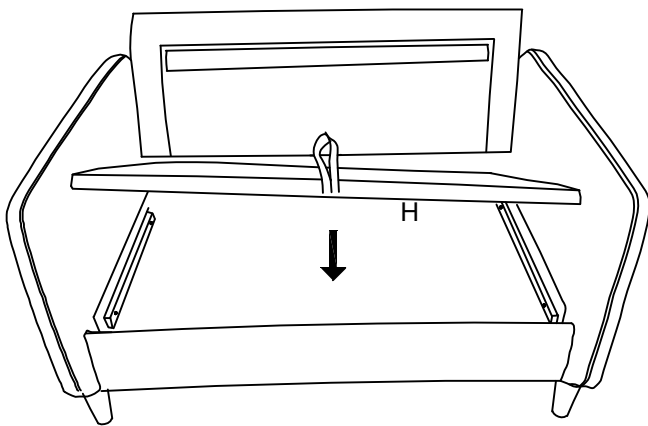

STEP 11

Place the seat/back cushion on the sofa as shown in the picture and secure it firmly to the sofa body using the velcro fasteners on the base/back cushion. If the fabric was wrinkles, please wait for 72 hours for the cushions fully rebound back.

I		1
K		2
L		1

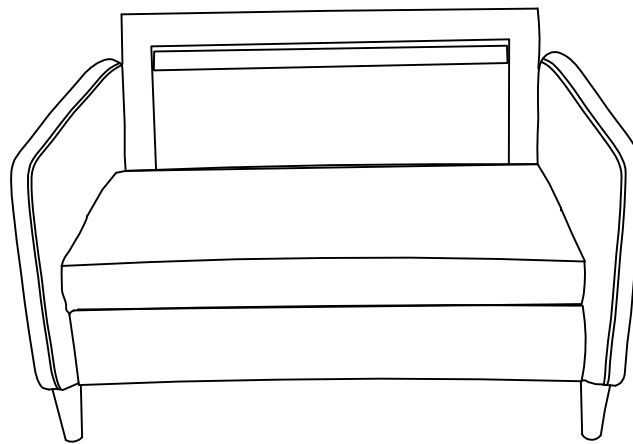

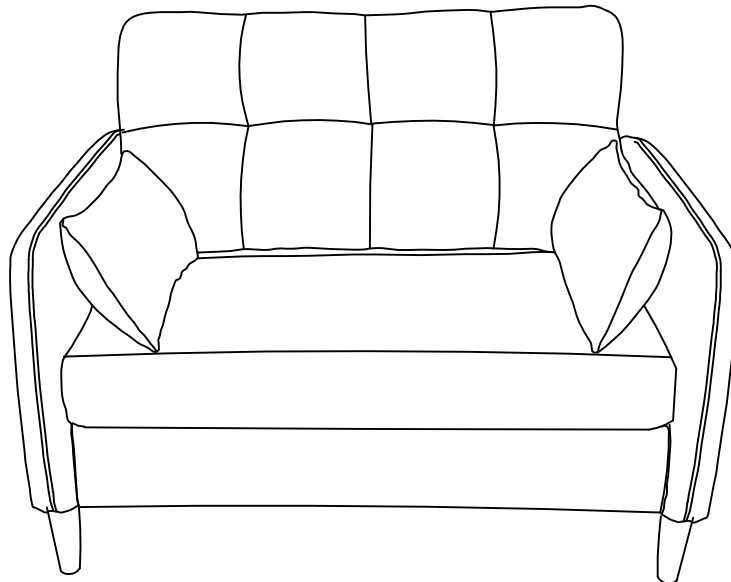
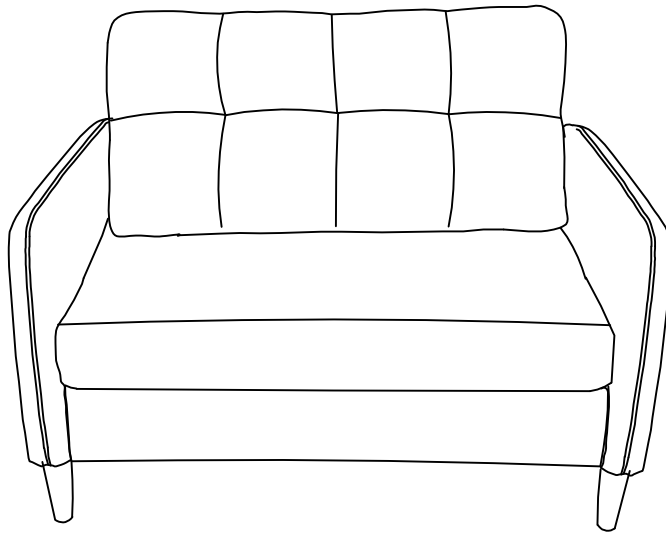

FAQ

Q1:Missing parts or some parts damaged when received.

A1:If you find some parts are missing or damaged from the box,please kindly send us messages to let us know the name of missing part regarding of the parts list of the instuction,we will send you the replacement and offer you the best solution asap.

Q2: Assemble Difficultly

A2:If there are any problems during the installation process, you can take photos and send them to us, and we will reply promptly. There are also installation videos on our Amazon page that you can view online.

Q3:Return Policy.

A3:Before returning the item, please contact us about return issue,please make sure that the box packaging is complete,the product is not damaged, stained and not affecting secondary sales. Return product that do not use the original packaging may be rejected, and the pictures may be requested to offer.