

WARNING

**** WE RECOMMEND INSTALLATION OF THIS LIGHTING FIXTURE BE DONE BY A LICENSED ELECTRICIAN ****

- * Switch off the main electrical supply from the main fuse box / circuit.
- * Breaker before installation.
- * Inspect item carefully before attempting to install.
- * If there is any damages or obvious defects, do not install.
- * Item may not be returned once it has been installed.











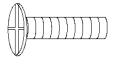

CARE AND MAINTENANCE

- * To clean the outside of the fixture, use a dry or slightly dampened clean cloth (use clean water, never a solvent) to wipe the surface of the fixture.
- * To clean the inside of the fixture, first disconnect power to the fixture by turning off the circuit breaker or by removing the fuse at the fuse box. Next, use a dry or slightly dampened clean cloth (use clean water, never a solvent) to wipe the interior surface of the fixture.
- * Do not use any cleaners with chemical, solvents or harsh abrasives. Use only a dry soft cloth to dust or wipe carefully.

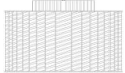
NOTICE& IMPORTANT SAFETY INSTRUCTIONS

- * Please make sure that you have all parts indicated before you begin assembly of this item
 - * This item should be assembled on a soft surface to prevent scratching the finish during assembly
 - * To reduce the risk of fire, electrical shock or injury to persons or property, please follow the guideline below for safe use and installation
 - *The external flexible cable or cord of this lamp cannot be replaced
- If the cord is damaged, the lamp shall be destroyed

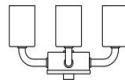
Part List and Hardware List

PIECE	DESCRIPTION	PICTURE	QUANTITY	PIECE	DESCRIPTION	PICTURE	QUANTITY
A	Wire Nut		3X	H	Closable Link		2X
B	Mounting Screw		2X	I	Chain		1X
C	Mounting Plate		1X	J	Fixture Loop		1X
D	Bulb		4X	K	Shade		1X
E	Canopy		1X	L	tube		1X
F	Hanging Loop		1X	M	Socket Assembly		1X
G	Canopy Nut		1X				

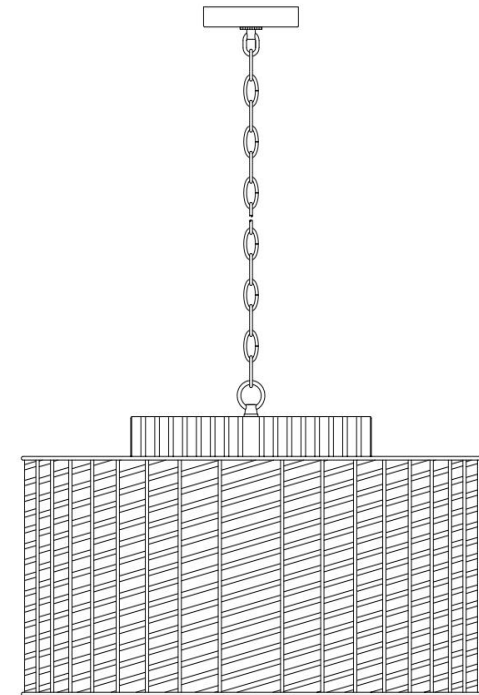

PREPARATION

- * Before beginning assembly of product, make sure all parts are present. Compare parts with package contents list and hardware contents list.
- * If any part is missing or damaged, do not attempt to assemble the product.
- * Estimated Assembly Time: 30 minutes.
- * If you are having difficulty, our friendly Customer Care team is always here to help.

NOTE: PLEASE USE TYPE "A" BULB MAX 40-WATT OR LED BULB MAX 9-WATT, THERE ARE 4*LED 4-WATT BULBS IN THE BOX

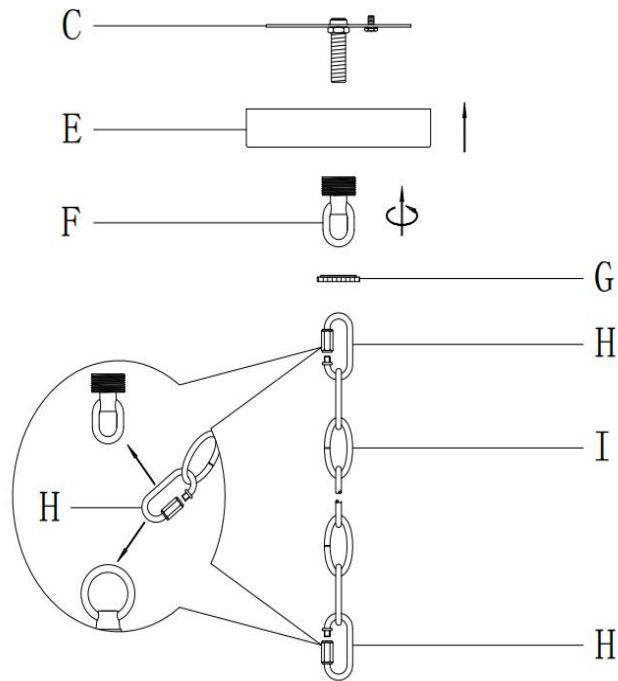

Step 1: Unpack all parts from cartons carefully.

Separate the Canopy Nut(G) from the Mounting Plate (C), Connect Mounting Plate (C) and Canopy(E) and Hanging Loop(F) by turning the Canopy Nut (G).

Place the Hanging Loop(F) onto the Closable Link(H).

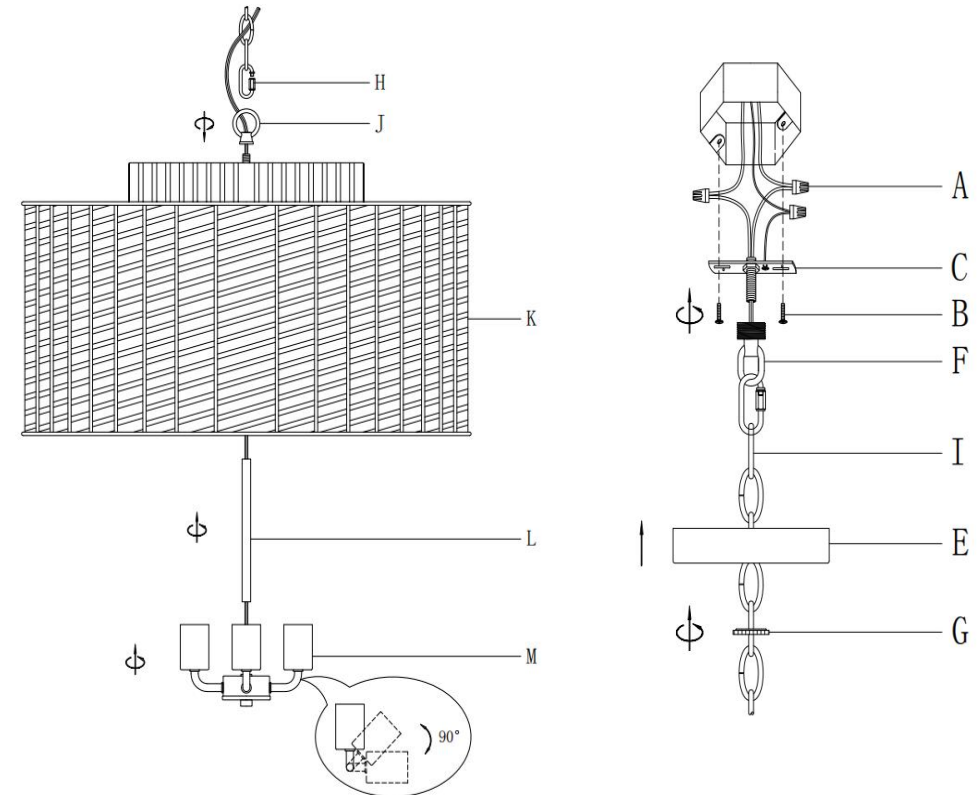

Step 2: Insert the fixture wire through the tube(L) shade (K) Fixture Loop (J) and tighten them . Connect the Fixture Loop (J) and chain (I) with Closable Link(H).then insert the fixture wire through the chain (I) and Canopy(E) to get desired length. Adjust the

Sockets (M) to the 90 degree position.

Separate the Mounting Plate(C) from the Canopy(E) by turning the Canopy Nut (G) anti-clockwise.

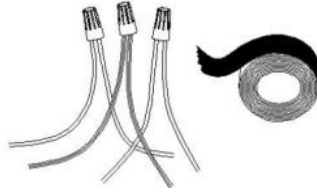
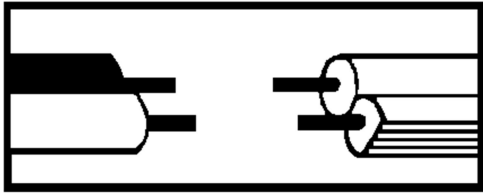

Step 3: Wire connection

Connect fixture neutral wire (ribbed) to the outlet box neutral wire (usually white) using a wire nut. Connect fixture hot wire (smooth with markings) to the outlet box hot wire (usually black) using a wire nut.

CAUTION: Do not reverse the hot and neutral connections

Grounding Instructions:

Wrap ground wire from outlet box around green ground screw on mounting bracket, no less than 2" from wire end. Tighten ground screw. If fixture is supplied with a ground wire, connect to outlet ground wire with a wire nut.

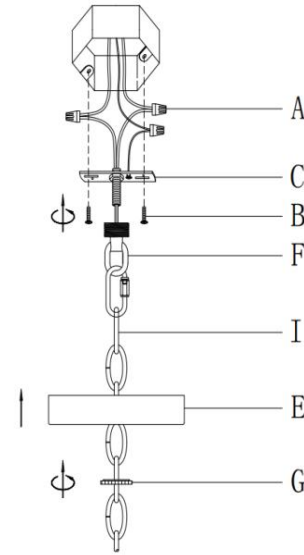

Step 4: Install the Mounting Plate(C) to the junction box with Mounting Screw (B).

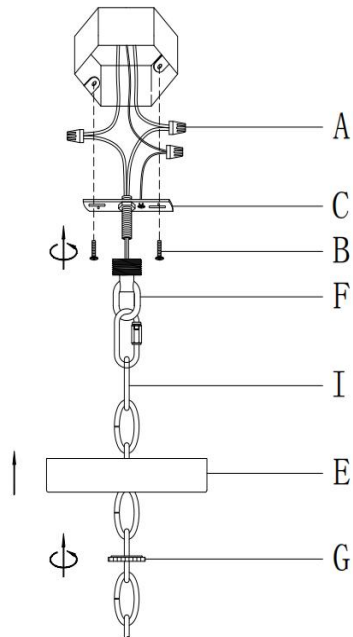

Step 5: Attach the Canopy(E) to the junction box and fix it by turning the Canopy Nut(G) clockwise.

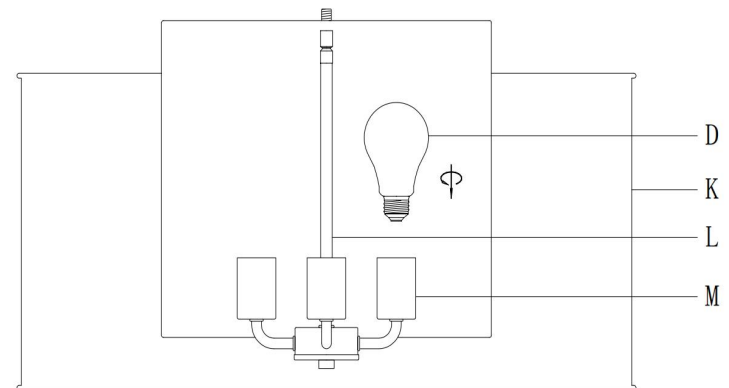

Step 6: Insert the bulbs (D) into the Sockets (M).