

# ASSEMBLY INSTRUCTIONS

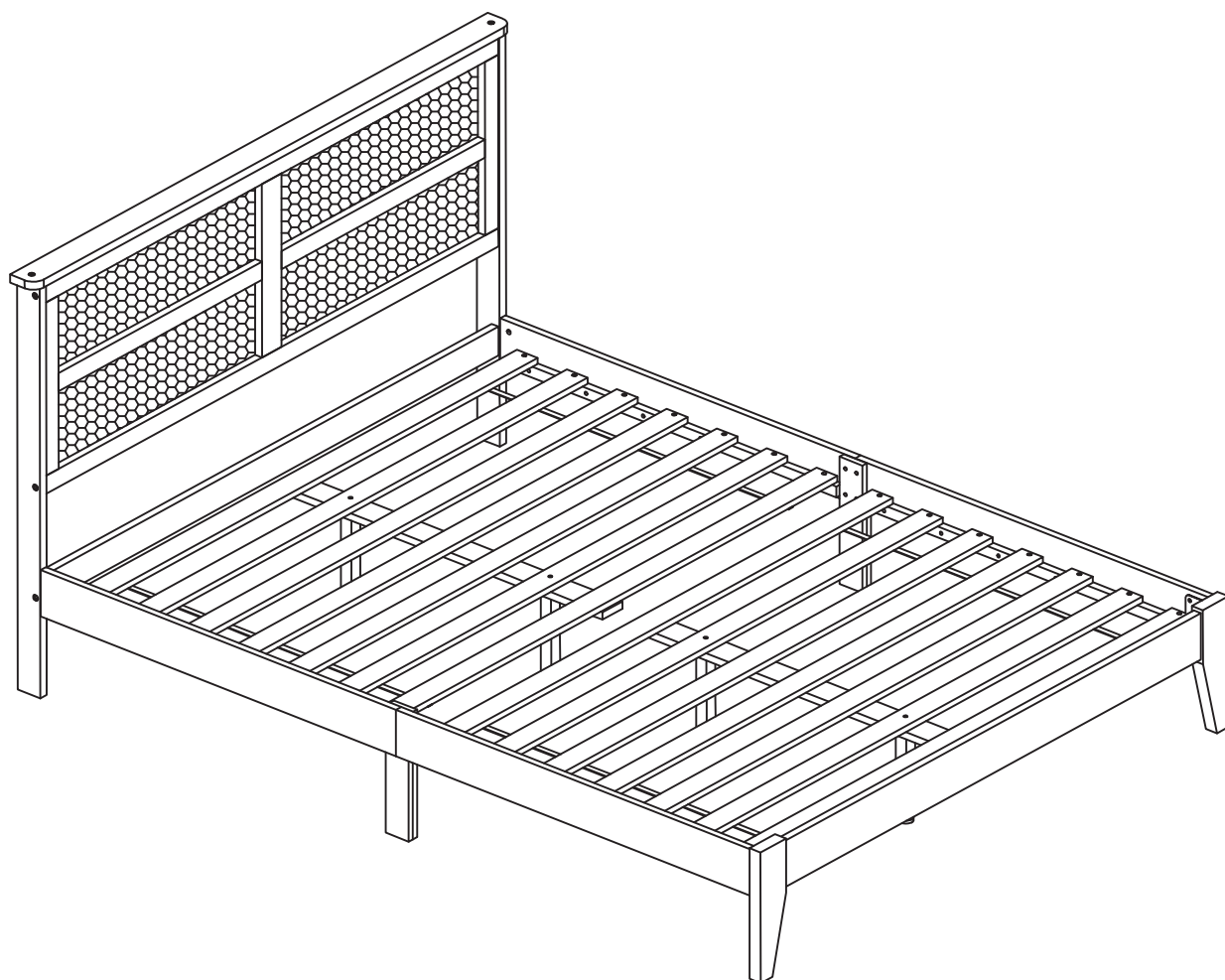

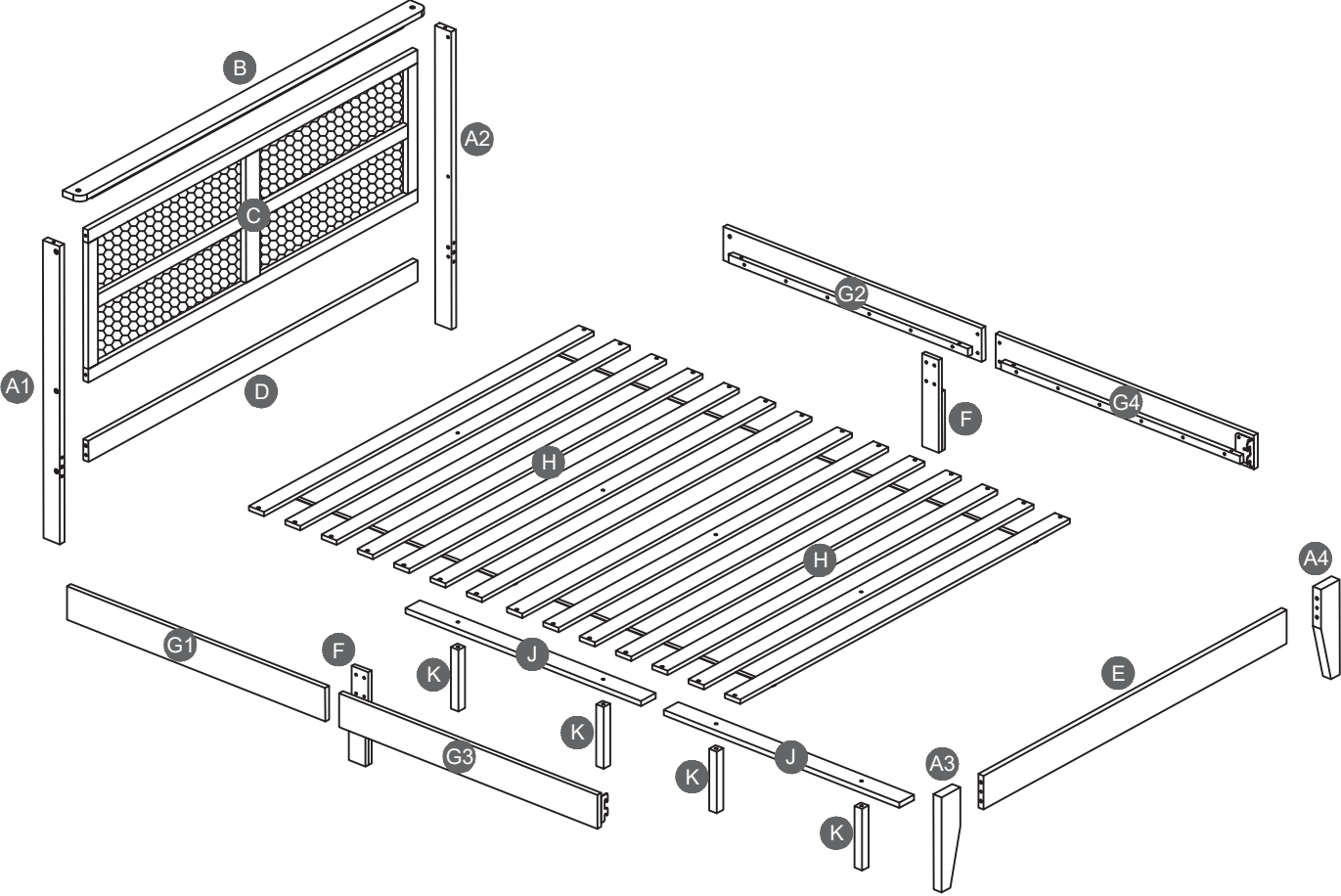









## QUEEN BED WITH HEADBORAD



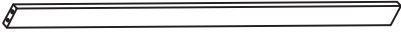

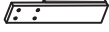
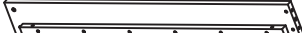
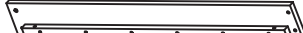



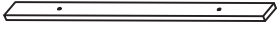
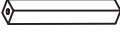



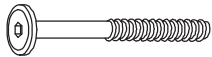

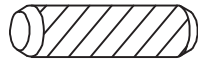
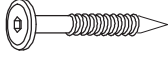
# Detail View

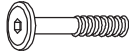

# Part List

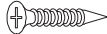
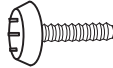
<b>A1</b>  Leg (Headboard Left) - 1pc	<b>A2</b>  Leg (Headboard Right) - 1pc	<b>A3</b>  Leg (Footboard Left) - 1pc
<b>A4</b>  Leg (Footboard Right) - 1pc	<b>B</b>  Top Panel (Headboard) - 1pc	<b>C</b>  Middle Panel (Headboard) - 1pc
<b>D</b>  Bottom Panel (Headboard) - 1pc	<b>E</b>  Panel (Footboard) - 1pc	<b>F</b>  Side Rail Support (Left & Right) - 2pcs
<b>G1</b>  Side Rail Left (Headboard) - 1pc	<b>G2</b>  Side Rail Right (Headboard) - 1pc	<b>G3</b>  Side Rail Left (Footboard) - 1pc
<b>G4</b>  Side Rail Right (Footboard) - 1pc	<b>H</b>  Bed Slats - 2Sets	<b>J</b>  Center Rail - 2pcs
<b>K</b>  Support Leg - 4pcs		

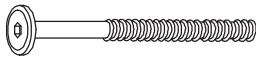
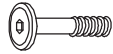
# Hardware List

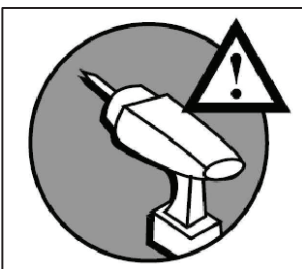
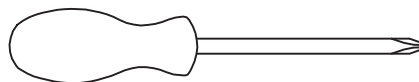

<b>1</b>  M6 x 60mm JCBC (12cs)	<b>2</b>  M6 x 15mm Barrel Nut (10pcs)	<b>3</b>  M10 x 30mm Wood Dowel (8pcs)
<b>4</b>  M6 x 40mm JCBC-W (2pcs)	<b>5</b>  M4 x 32mm CSK Screw (3pcs)	<b>6</b>  M6 Half Moon Nut (2pcs)
<b>7</b>  Flat Washer (2pcs)	<b>8</b>  Split Lock Washer (2pcs)	<b>9</b>  M6 x 25mm JCBC (8pcs)
<b>10</b>  M6 x 30mm JCBC-W (8pcs)	<b>11</b>  M4 x 25mm CSK Screw (20pcs)	<b>12</b>  Adjustable Screw (4pcs)
<b>13</b>  Flat Washer (8pcs)	<b>14</b>  M6 x 110mm JCBC (4pcs)	<b>15</b>  M8 x 20mm JCBB (4pcs)
<b>16</b>  M4 Allen Key (1pc)	<b>17</b>  M5 Allen Key (1pc)	

## ASSEMBLY TOOLS REQUIRED ( NOT INCLUDED )



**PLEASE BE CAREFUL DO NOT DAMAGE THE HOLE POSITION WHEN YOU USE POWER TOOLS !**

# STEP 1:

<b>1</b>		<b>2</b>		<b>3</b>	
<b>6PCS</b>		<b>6PCS</b>		<b>2PCS</b>	

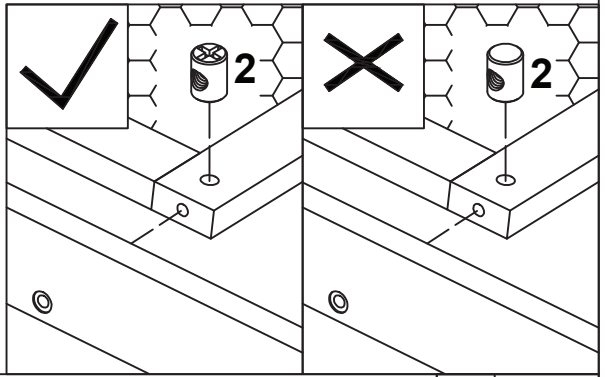
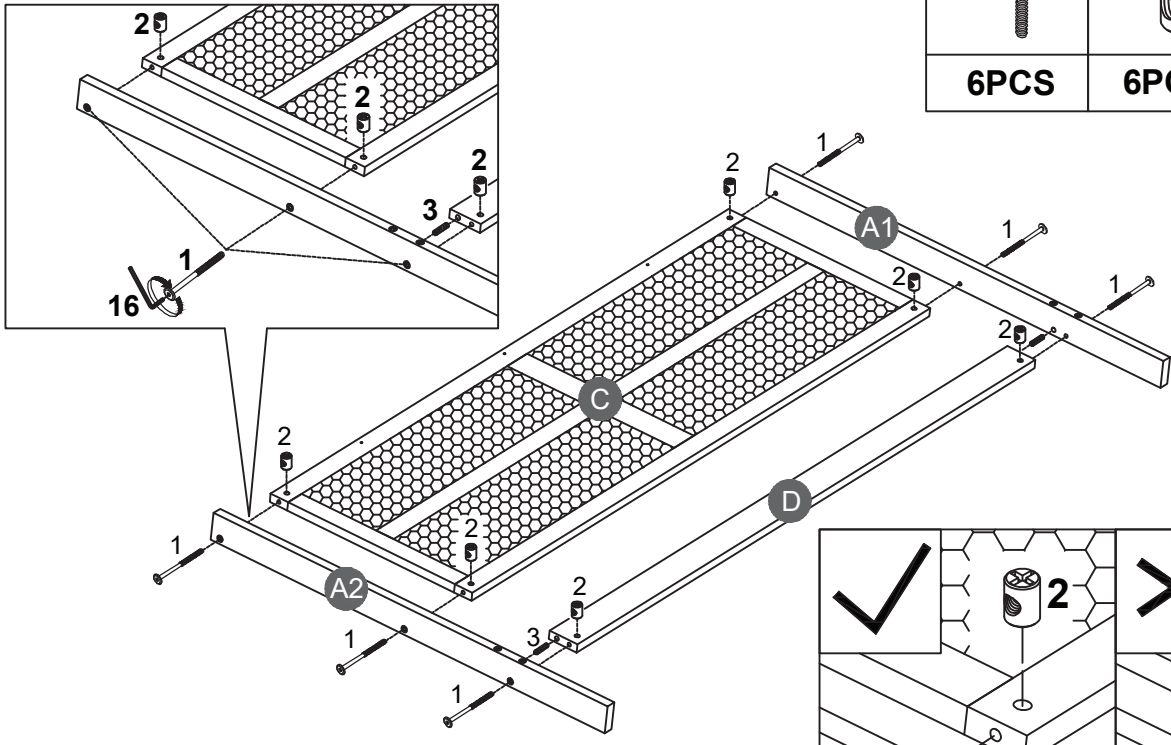

Note: Part 2 will face up with the "x" mark on it, otherwise it cannot be tightened

# STEP 2:

<b>4</b>	
<b>2PCS</b>	

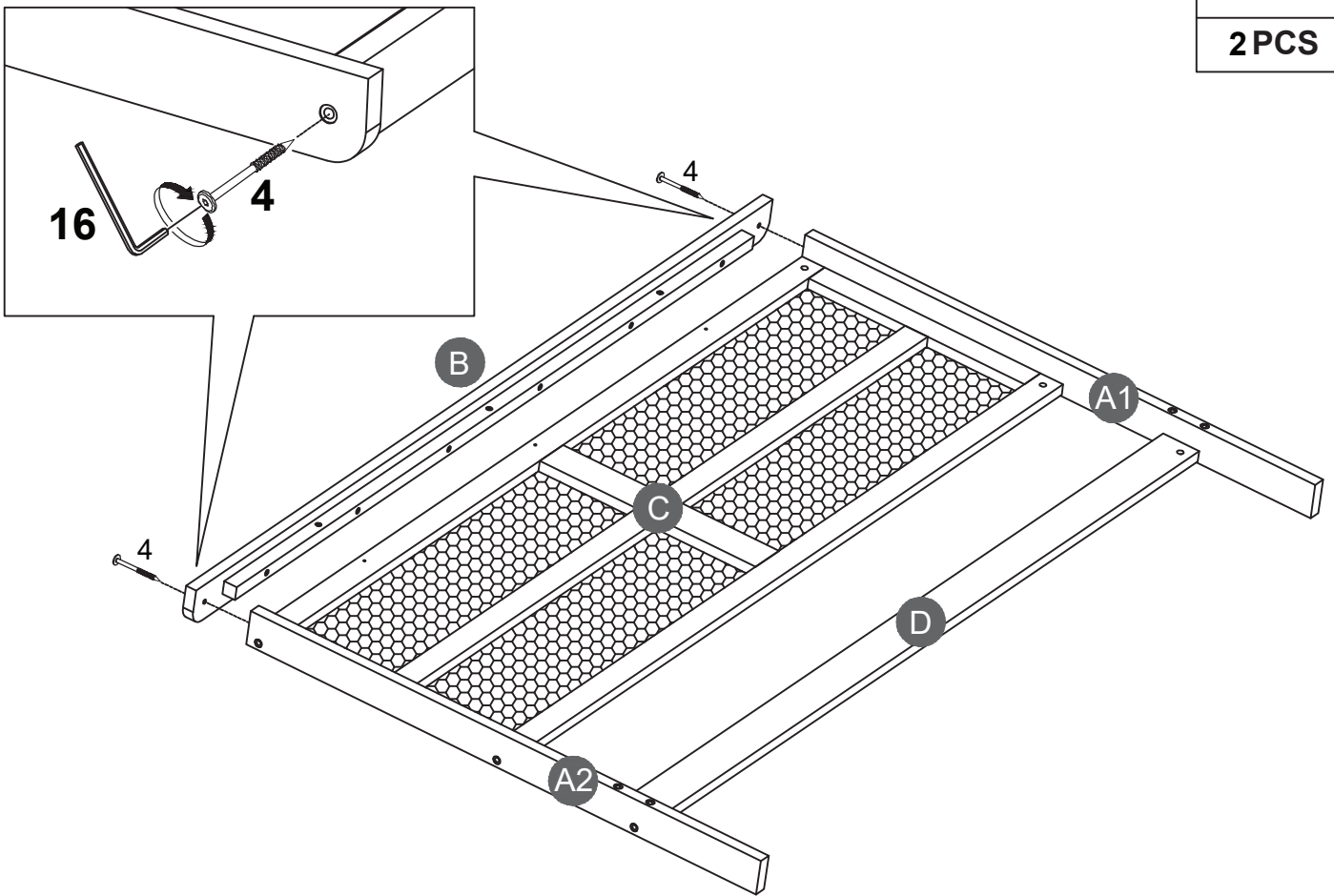

**STEP 3:**

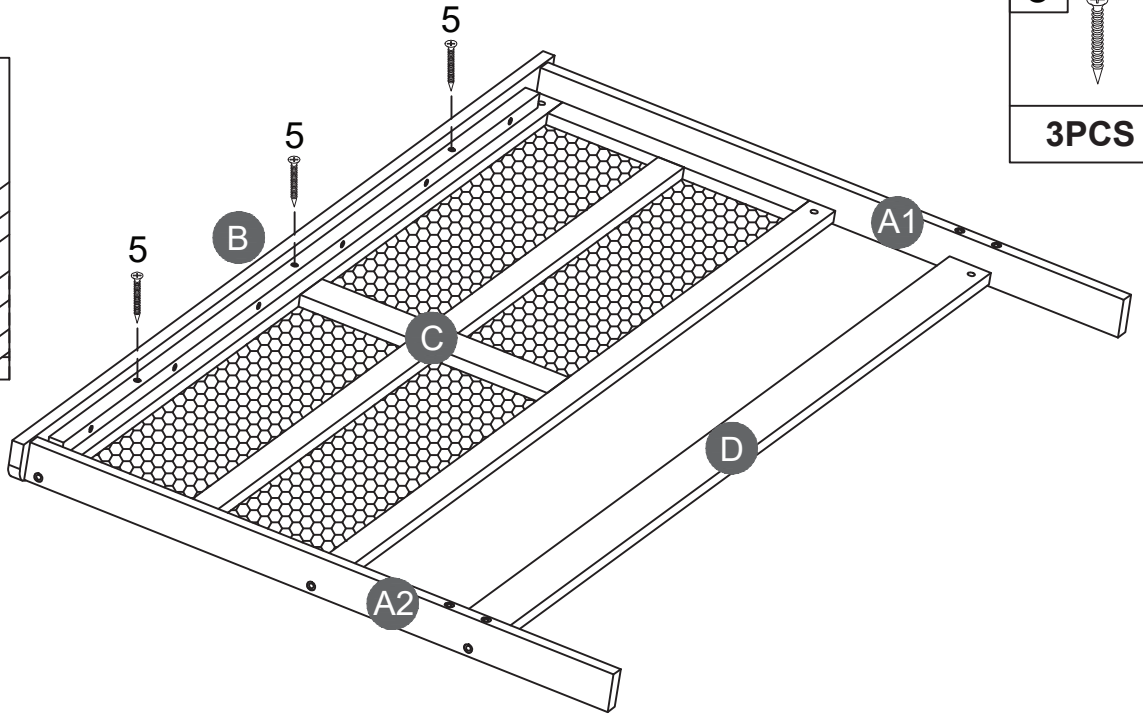
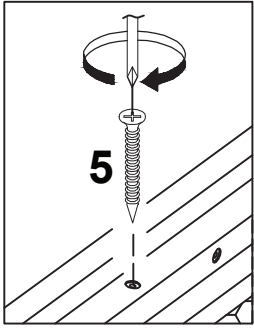



<b>5</b>	
<b>3PCS</b>	

**STEP 4:**

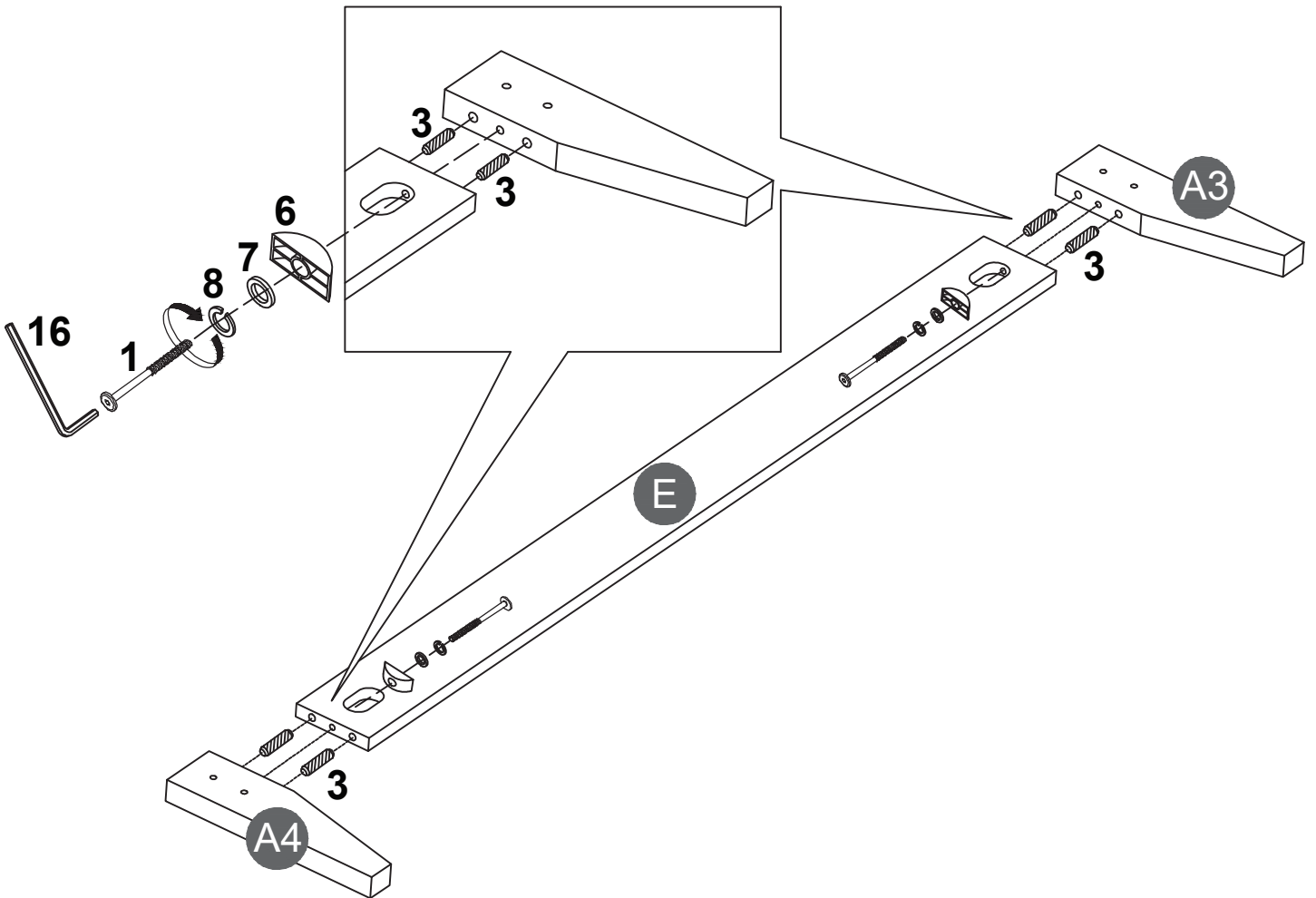
<b>1</b>		<b>3</b>		<b>6</b>		<b>7</b>		<b>8</b>	
<b>2PCS</b>		<b>4PCS</b>		<b>2PCS</b>		<b>2PCS</b>		<b>2PCS</b>	





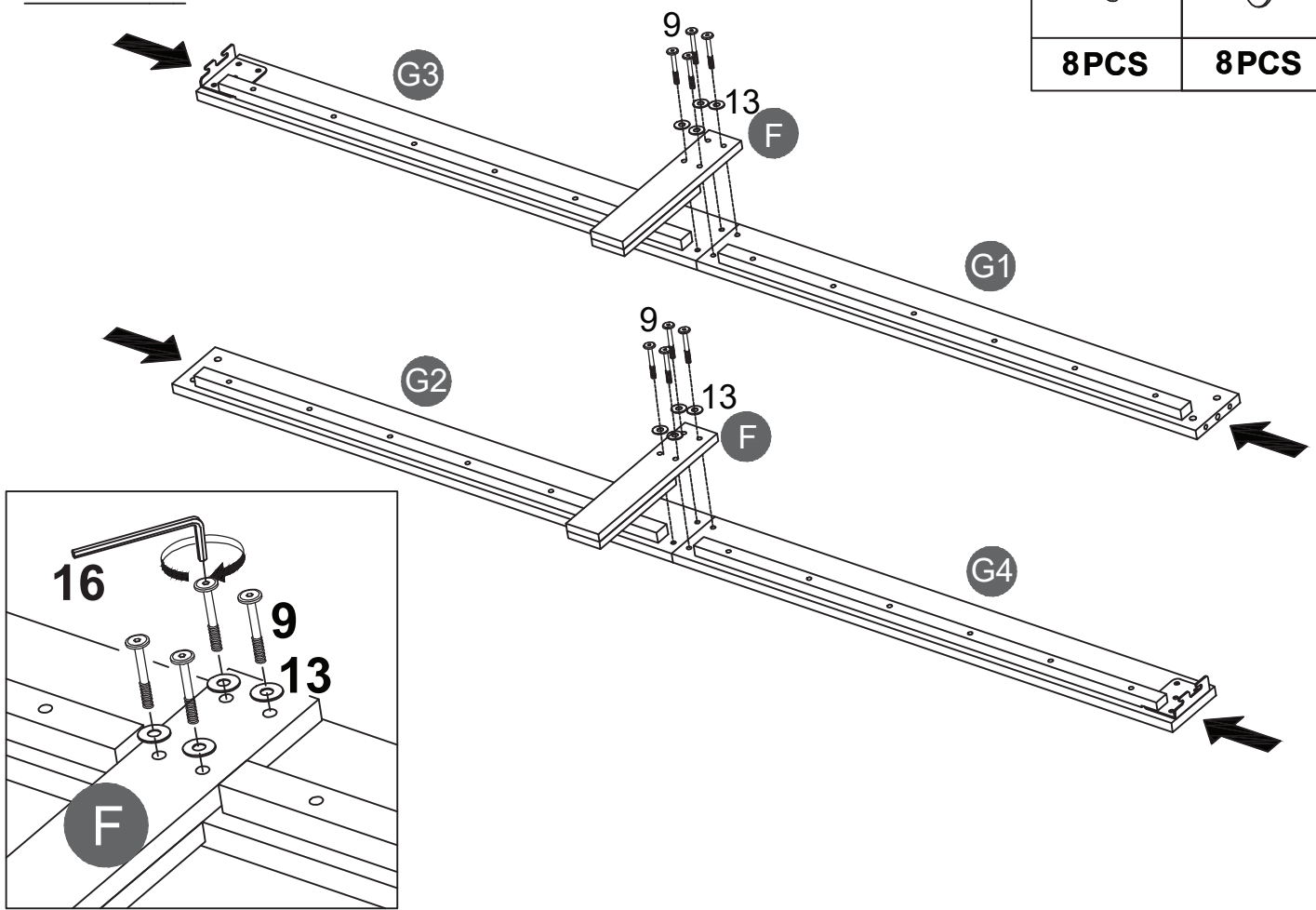

**STEP 5:**

<b>9</b>		<b>13</b>	
<b>8PCS</b>		<b>8PCS</b>	



**STEP 6:**



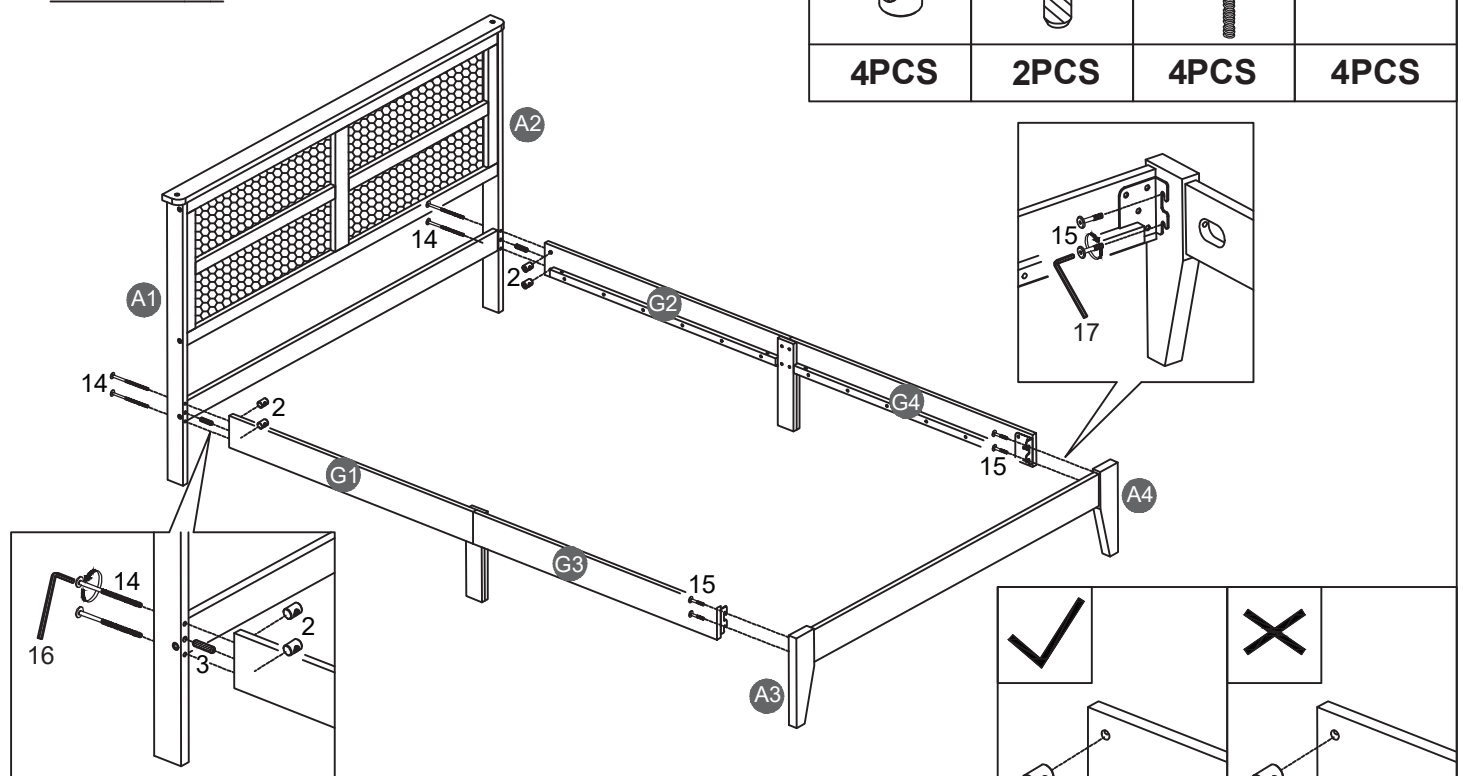

<b>2</b>		<b>3</b>		<b>14</b>		<b>15</b>	
<b>4PCS</b>		<b>2PCS</b>		<b>4PCS</b>		<b>4PCS</b>	

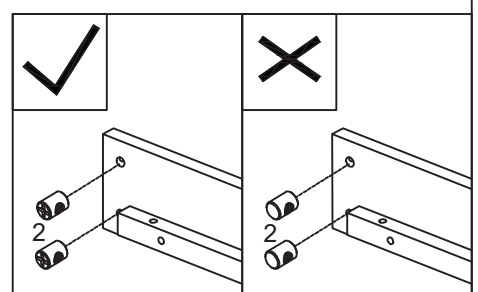

Note: Part 2 will face up with the "x" mark on it, otherwise it cannot be tightened



**STEP 7:**

<b>1</b>		<b>10</b>		<b>11</b>		<b>12</b>	
<b>4PCS</b>		<b>8PCS</b>		<b>20PCS</b>		<b>4PCS</b>	

