

**PRODUCT SPECIFICATIONS**

Elkay Lustertone™ Classic Stainless Steel 17" x 20" x 5-1/2", Single Bowl Drop-in ADA Sink with Quick-clip. Sink is manufactured from 18 gauge 304 Stainless Steel with a Lustrous Satin finish, Rear Center drain placement, and Bottom only pads.

<b>Installation Type:</b>	Drop-in
<b>Material:</b>	304 Stainless Steel
<b>Special Features:</b>	Quick-Clip Mounting System
<b>Finish:</b>	Lustrous Satin
<b>Gauge:</b>	18
<b>Sound Deadening:</b>	Bottom only pads
<b>Number of Bowls:</b>	1
<b>Sink Dimensions:</b>	17" x 20" x 5-1/2"
<b>Bowl 1 Dimensions:</b>	14" x 14" x 5-3/8"
<b>Drain Size:</b>	3-1/2" (89mm)
<b>Drain Location:</b>	Rear Center
<b>Minimum Cabinet Size:</b>	21"
<b>Mounting Hardware:</b>	Included for 3/4" (19mm) countertop
<b>Template Included:</b>	No
<b>Cutout Template #:</b>	<a href="#">1000001272</a>

Template is available for download at [elkay.com](#). CAD software will be required to open the template.

**Cutout Dimensions for Drop-in Installation:**

16-3/8" x 19-3/8" (416mm x 492mm) with 1-1/2" (38mm) corner radius

<b>Custom Options</b>	
<input type="checkbox"/> Type 316 Stainless Steel	
<b>Drain Location</b>	
<input type="checkbox"/> Right Rear	<input type="checkbox"/> Left Rear
<input type="checkbox"/> Center	<input type="checkbox"/> Center Rear
<b>Overflow Location</b>	
<input type="checkbox"/> Front	<input type="checkbox"/> Rear
<b>Alternate Punching</b>	
<input type="checkbox"/> Faucet Model:	<input type="checkbox"/> Punch Required:
<b>Sink Size</b>	
<input type="checkbox"/> Bowl Depth:	<input type="checkbox"/> Drainboard Width:



**AMERICAN PRIDE. A LIFETIME TRADITION.**

Like your family, the Elkay family has values and traditions that endure. For almost a century, Elkay has been a family-owned and operated company, providing thousands of jobs that support our families and communities.



**Product Compliance:** ADA & ICC A117.1  
ASME A112.19.3/CSA B45.4  
Buy American Act



Sinks are listed by IAPMO® as meeting the applicable requirements of the Uniform Plumbing Code®, International Plumbing Code®, and National Plumbing Code of Canada.



Complies with ADA & ICC A117.1 accessibility requirements when installed according to the requirements outlined in these standards.

[Clean and Care Manual \(PDF\)](#)  
[Installation Instructions \(PDF\)](#)  
[Warranty \(PDF\)](#)

**Similar models are available with:** U Channel mounting system, additional ADA depths

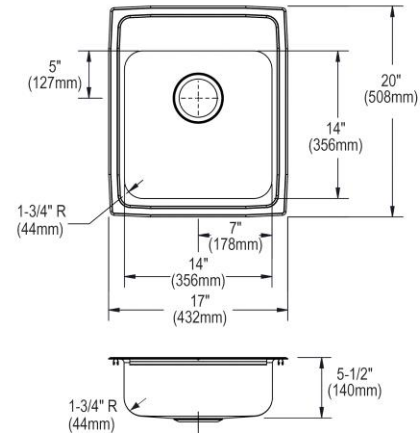

PART: \_\_\_\_\_ QTY: \_\_\_\_\_

PROJECT: \_\_\_\_\_

CONTACT: \_\_\_\_\_

DATE: \_\_\_\_\_

NOTES: \_\_\_\_\_

APPROVAL: \_\_\_\_\_

*In keeping with our policy of continuing product improvement, Elkay reserves the right to change product specifications without notice. Please visit [elkay.com](#) for the most current version of Elkay product specification sheets. This specification describes an Elkay product with design, quality, and functional benefits to the user. When making a comparison of other producers' offerings, be certain these features are not overlooked.*



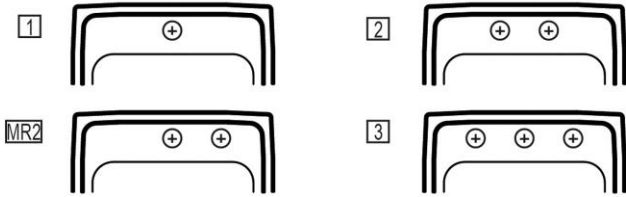

**Hole Drilling Configurations:**

1-1/2" (38mm) Diameter Faucet Holes on 4" (102mm) Centers

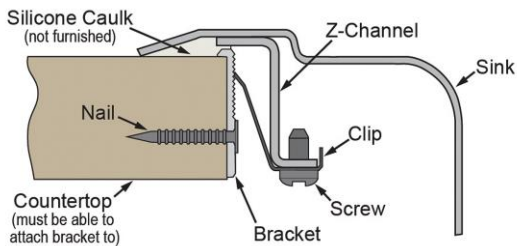

**Installation Profile:**



Optional Accessories		
<a href="#">CB1613</a>	Elkay Hardwood 16-3/4" x 13-1/2" x 1" Cutting Board <a href="#">Spec Sheet (PDF)</a>	
<a href="#">LK99</a>	Elkay Deluxe 3-1/2" Drain Type 304 Stainless Steel Body Strainer Basket Rubber Seal and Tailpiece <a href="#">Spec Sheet (PDF)</a>	
<a href="#">LKAD35</a>	Elkay 3-1/2" Drain Fitting" Stainless Steel Body Strainer Basket and Offset Tailpiece <a href="#">Spec Sheet (PDF)</a>	
<a href="#">LKWRB1414SS</a>	Elkay Stainless Steel 13" x 13" x 7" Rinsing Basket <a href="#">Spec Sheet (PDF)</a>	

*In keeping with our policy of continuing product improvement, Elkay reserves the right to change product specifications without notice. Please visit [elkay.com](http://elkay.com) for the most current version of Elkay product specification sheets. This specification describes an Elkay product with design, quality, and functional benefits to the user. When making a comparison of other producers' offerings, be certain these features are not overlooked.*