



**INSTRUCTIONS D'ASSEMBLAGE
ASSEMBLY INSTRUCTIONS**

**TABLE D'APPOINT -
GRIS ET METAL CHROME**



**ACCENT TABLE -
GREY WITH CHROME METAL**



**POUR DE L'ASSISTANCE OU POUR COMMANDER
DES PIÈCES CONTACTEZ NOTRE DÉPARTEMENT
DE SERVICE À LA CLIENTÈLE.**

**FOR ASSISTANCE OR TO ORDER PARTS
CONTACT OUR CUSTOMER SERVICE DEPARTMENT**

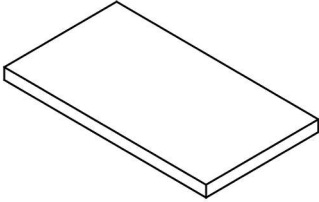
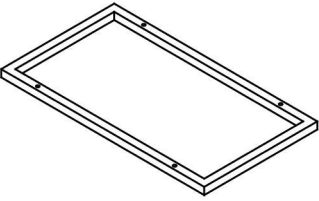
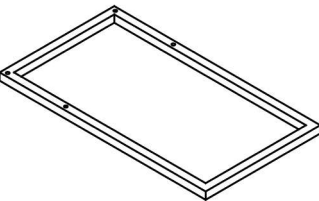
LISTE DES PIÈCES
PARTS LIST

PIÈCE / PART #	IMAGE	DESCRIPTION	QTY / QTÉ
1		<p style="text-align: center;">TABLE TOP SURFACE DE TABLE</p>	1
2		<p style="text-align: center;">TOP FRAME CADRE DE SURFACE</p>	1
3		<p style="text-align: center;">BOTTOM FRAME CADRE DU BAS</p>	1
4		<p style="text-align: center;">FRONT FACING LEFT LEG PATTE AVANT GAUCHE</p>	1
5		<p style="text-align: center;">FRONT FACING RIGHT LEG PATTE AVANT DROITE</p>	1

LISTE DES PIÈCES DE MONTAGE
HARDWARE LIST

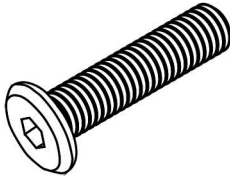
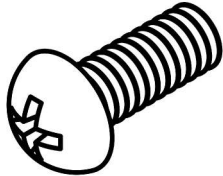
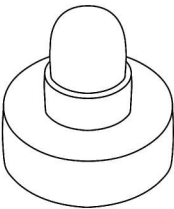
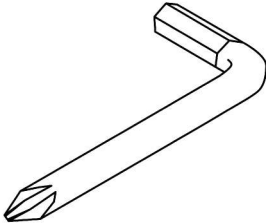
PIÈCE / PART #	IMAGE	DESCRIPTION	QTY / QTÉ
A		ASSEMBLING SCREW - $\text{Ø}3/8'' \times 1\ 1/4''$ VIS D'ASSEMBLAGE - $\text{Ø}3/8'' \times 1\ 1/4''$	4
B		ASSEMBLING BOLT - $\text{Ø}1/4'' \times 7/8''$ BOULON D'ASSEMBLAGE - $\text{Ø}1/4'' \times 7/8''$	4
C		ASSEMBLING BOLT - $\text{Ø}1/8'' \times 1/2''$ BOULON D'ASSEMBLAGE - $\text{Ø}1/8'' \times 1/2''$	4
D		FLOOR PROTECTOR - $\text{Ø}1/4''$ PROTECTEUR DE PLANCHER - $\text{Ø}1/4''$	4
E		HEX KEY CLÉ HEXAGONALE	1

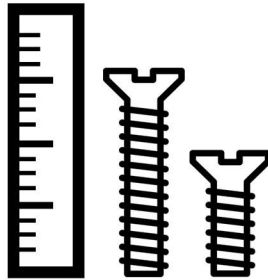

OUTIL DE VÉRIFICATION DE DIMENSIONS DES PIÈCES
HARDWARE DIMENSIONS VERIFICATION TOOL

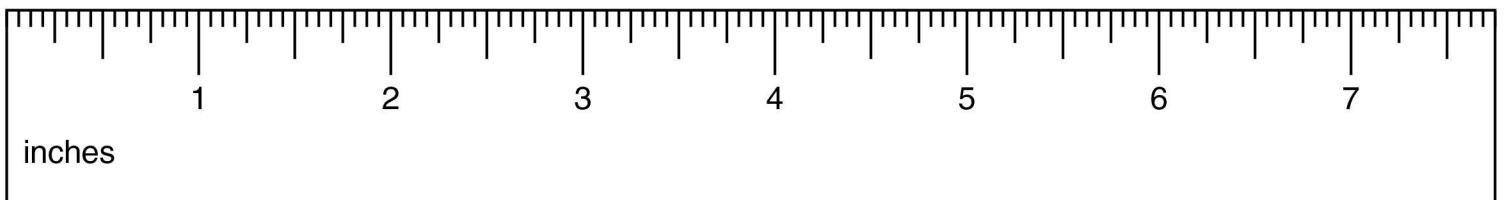

ÉTAPE / STEP 1

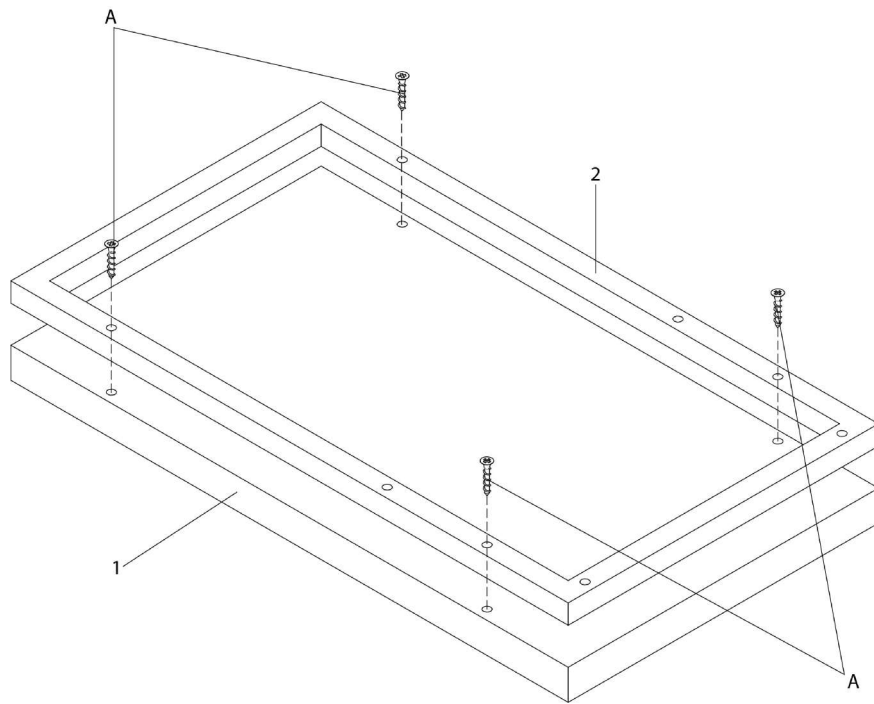

ÉTAPE / STEP 2

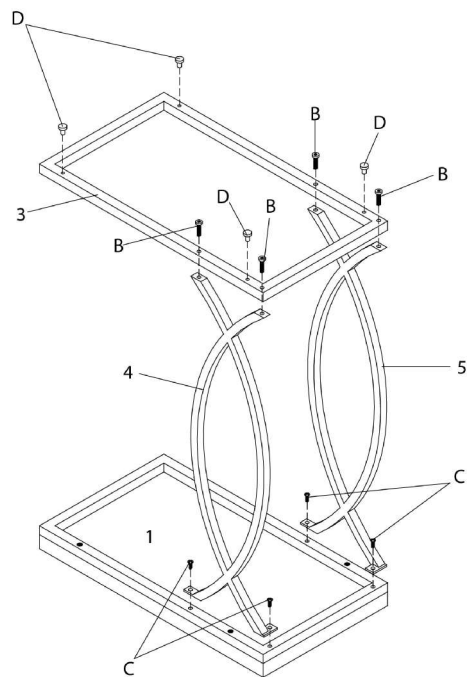

ÉTAPE / STEP 3

