







ASSEMBLY INSTRUCTION

ITEM NO:ST140-BLK/WHT//GRY

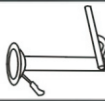

| No | Spare Part | Quantity |
|----|---|----------|
| A |  | 1 |
| B |  | 1 |
| C |  | 1 |
| D |  | 1 |
| E |  | 1 |
| F |  | 4 |
| G |  | 1 |

STEP 1

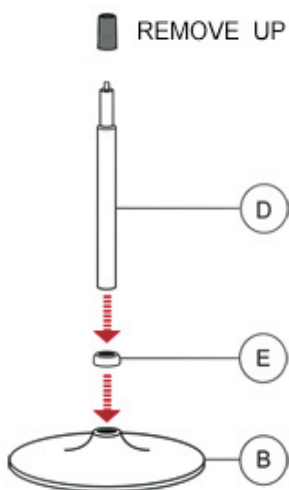

STEP 2

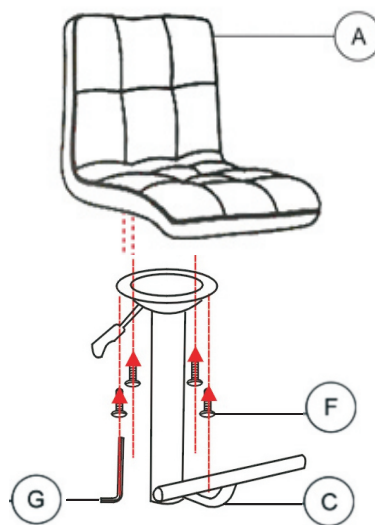

STEP 3

