

ASSEMBLY INSTRUCTION

A Seat Frame

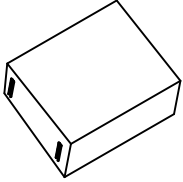

1pc

B Back Frame

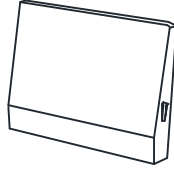

1pc

C Left Panel



1pc

D Right Panel



1pc

E Seat Cushion

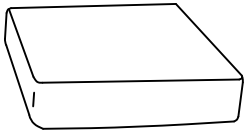

1pc

F Back Cushion

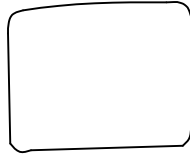

1pc

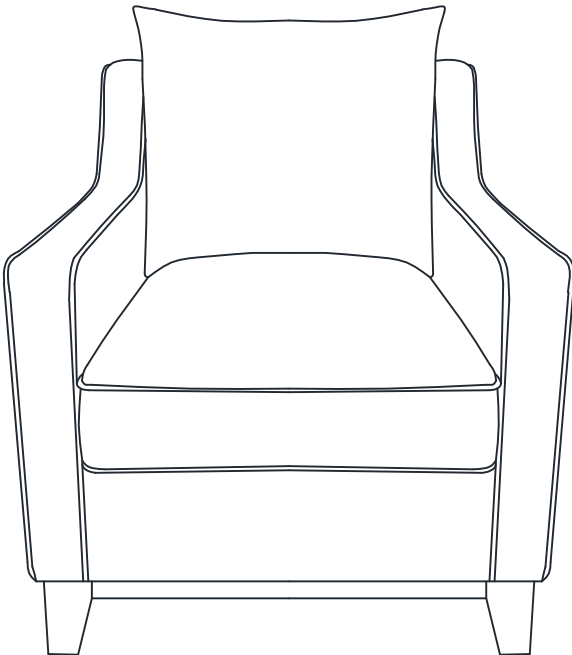

This page lists all the contents included in the box. As you unpack and prepare for assembly, place the contents on a carpeted or padded area to protect them from damage.

1 Hook on the Left Panel (C) & Right Panel (D) to Seat Frame (A) properly.

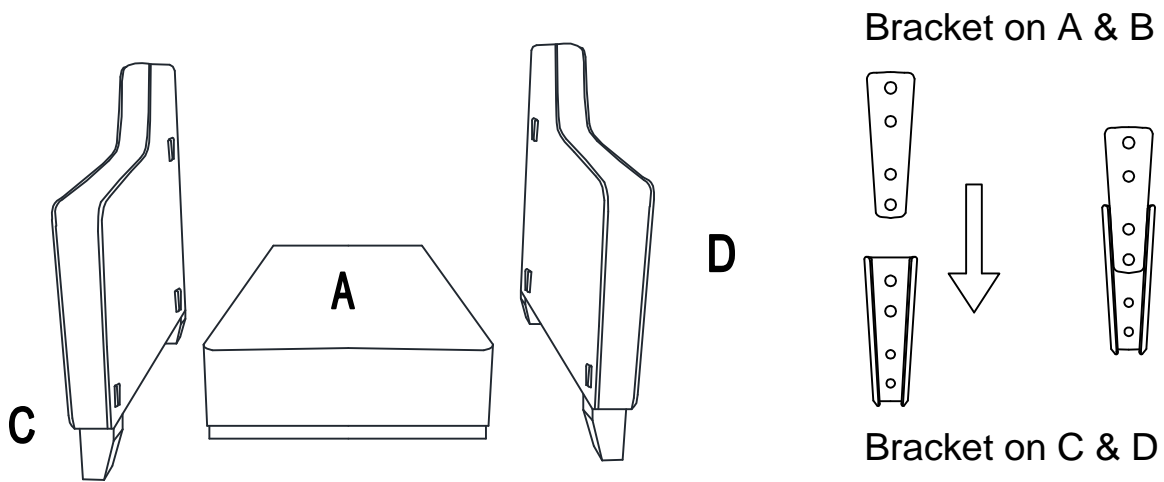

2 Hook on the Back Frame (B) to Left Panel (C) & Right Panel (D) properly.

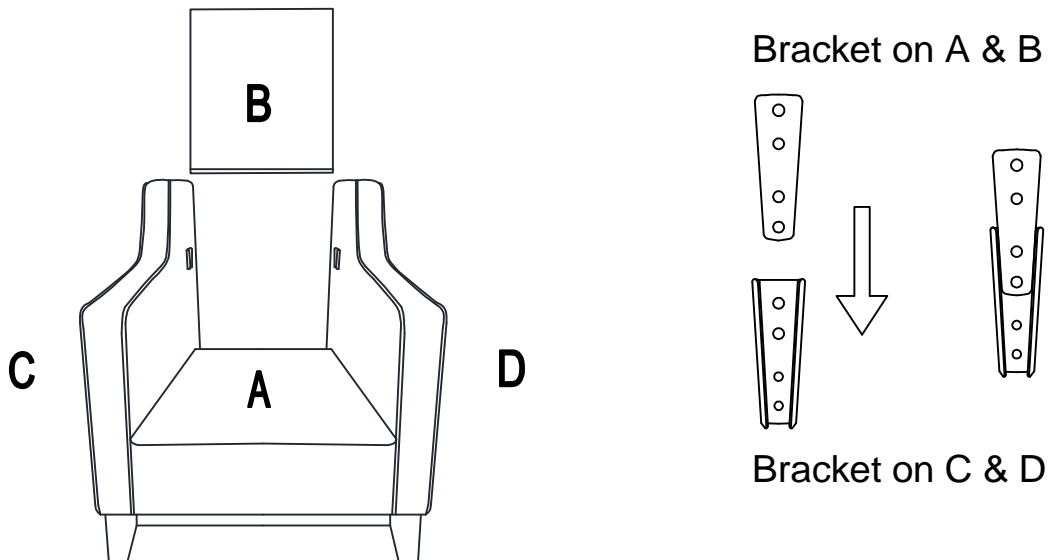

3 Place Seat Cushion (E) and Back Cushion (F) on the chair properly.

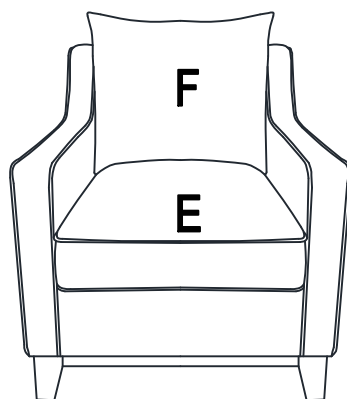

Cleaning & Care

Treat surface with care. Surface is resistant to scratches but is not scratch resistant. Clean surfaces with a dry or damp soft cloth. Do not use abrasive cleaners.