



WarmlyYours

PRODUCT

CATALOG

# Floor Heating



# About WarmlyYours Heating

---

Frequently, we are asked how we chose the name of our company. When we began as an electric radiant heating products business over 20 years ago, we wanted a name that would embody the very essence of our business philosophy – treat our customers well and offer the very best floor-warming systems and services in the industry. And above all else, always deliver on those promises to our customers.

The name WarmlyYours reflects our deep, personal commitment to providing our customers with the exceptional customer service that they deserve. We welcome any questions and relish the opportunity to provide our customers with prompt and friendly assistance. Listening to feedback from thousands of homeowners and installers, we continue to improve on everything we do in our effort to better serve our customers. As a result, we have expanded our portfolio to include other radiant heating products – such as towel warmers and radiant panels – to bring comfort and affordable luxury to all areas of the home.

---

WarmlyYours has locations in both the United States and Canada. Throughout North America, our customers recognize our commitment to exceptional service and product quality.

---

**99%** ★★★★★  
*of our customers report complete satisfaction with our service*

---

**97%** ★★★★★  
*of our customers report complete confidence in our product quality*



# Radiantly Yours

---

At WarmlyYours, we are proud to offer a radiant solution for every area of life. From our flagship product, our electric floor heating systems, to our outdoor snow melting and deicing options, our award-winning LAVA® radiant panels and complete electric towel warmer collection, we are confident that you will find every need more than matched by our range of high-quality products.

Each product is designed to install easily and includes 24/7 technical support, saving you time and money. Your dedicated account manager is there to support you with a quotation and custom installation plan within 24 hours, and we'll ship your order the very same day you place it. We promise you that our focus on customer service beats any other company in the industry.

Julia Billen – President & Owner

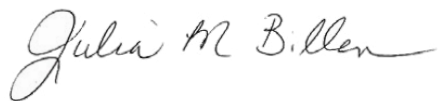

---

## WarmlyYours Advantage

For over 20 years, WarmlyYours, located in the U.S. and Canada, has offered the industry's most innovative, energy-efficient, and maintenance-free electric radiant heating solutions for virtually any flooring surface and any room. We offer a full collection of radiant products, from floor heating and snow melting to towel warmers and our infrared heating panels, there is a product that fits every client's need and style.

We are committed to serving you with the exceptional service and product quality that you deserve.

---

# Start Out Right...

---

With our trusted experience in producing high-quality, innovative radiant heat products, we not only make comfort attainable, but we make the whole experience easy for you to provide radiant warmth for your clients.

## Expansive Product Portfolio

WarmlyYours has a heating system for nearly every floor-type—from tile to nailed hardwood and everything in-between. Our team of Radiant Experts will make sure that you find the perfect heating system for your project.

## Heat Loss Calculator

Can electric floor heating be the primary heat source in your project? Now it's easier than ever to find out the answer with the WarmlyYours Heat Loss Calculator. With just a few details about your project, this free online tool will estimate how much heat is being lost in a room and if electric floor heating can be the primary heat source.

## Operating Cost Calculator

Input the size of the area that you would like to heat, along with the cost of the kWh in your state, and we'll tell you how much it will cost to heat the room or area, so that you can easily and accurately provide this information to your client.

## Same Day Shipping

Order before 4:00 PM Central Standard Time (in U.S. and Canada), and we'll ship that day, so you can keep your projects moving.



# Finish Strong...

---

Our No Nonsense™ Warranty is renowned for being an industry best: we will cover not only the cost of labor, but also the cost of the floor itself.

## Industry Leading 24/7 Installation Support

We're here for you. Call us anytime – day or night, weekday or weekend – with any questions or installation challenges. That's our commitment to you and your business.

## WarmlyYours No Nonsense™ Warranty

WarmlyYours No Nonsense™ Warranty is the most comprehensive warranty in the industry. We guarantee our indoor floor heating elements to be free from defects in material and workmanship for 25 (TempZone™) and 5-10 (Environ™) years from the date of purchase. Because we don't prorate your coverage, you have the same coverage over the entire life of the warranty. Unlike other companies, WarmlyYours will cover the cost of the warming roll AND the floor covering material AND labor in the event of a defect.

## No Restocking Fees

At WarmlyYours, we do not have restocking fees for any of our products.

## Open Return Policy

Our open return policy is simple—there are no time limits. If we still sell the product and it's in resalable condition, you may return it at any time—even years later. We know that life doesn't always run according to an ideal schedule, and at WarmlyYours, you come first.

# The WarmlyYours SmartPlan™

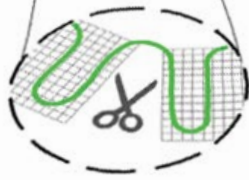
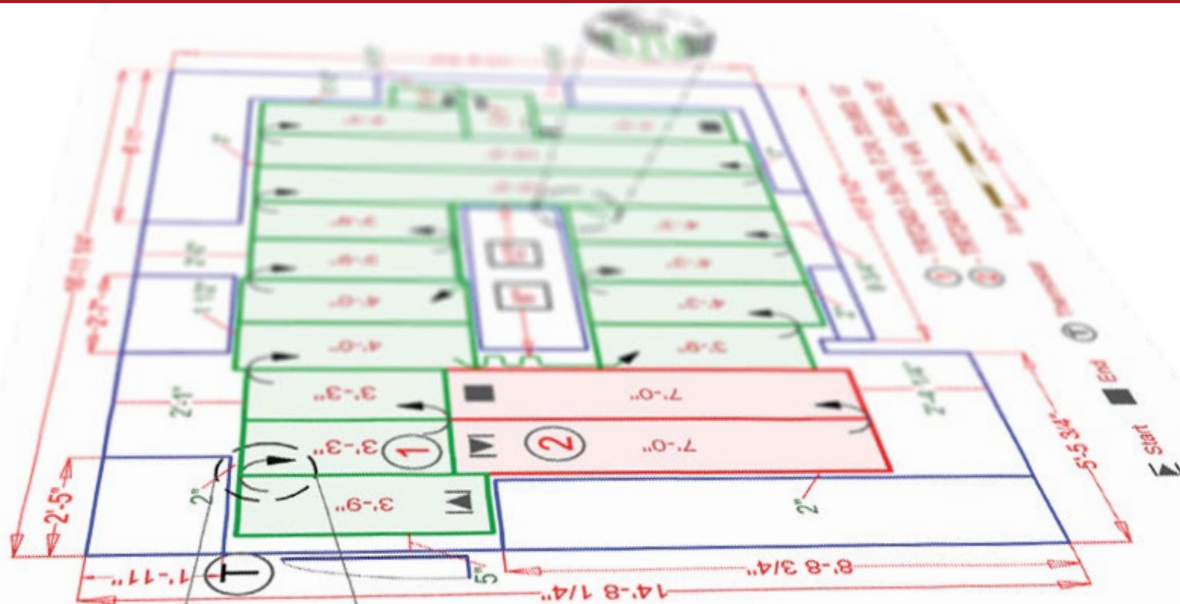

## Life is easier when you have a plan.

WarmlyYours has condensed decades of radiant heating experience into our FREE, no obligation SmartPlans™. Whether you're installing floor heating or a snow melting system, a WarmlyYours SmartPlan™ makes sure your project starts off right and finishes strong.

### These complimentary packages, compiled by a team of skilled engineers, include:

- An itemized product quote so you know the exact pricing for your project.
- An electrical plan that tells you exactly what's needed to get your system up and running.
- An installation plan that gives detailed information to cut down on time and effort.

All you have to do to take advantage of this service is to provide WarmlyYours with a simple floor plan sketch, and you'll receive your SmartPlan™, typically within 24 hours. Anyone can draw a floor plan sketch—it doesn't have to be fancy, it just has to show the room's dimensions and note any permanent fixtures like tubs, cabinets, or air-vents.

### You can send your floor plan sketch to WarmlyYours by:

- Drawing or uploading it directly to the WarmlyYours Radiant Floor Heating Quote Builder.
- Faxing it to us at (800) 408-1100.
- Scanning or taking a photo and emailing the file to us at [info@WarmlyYours.com](mailto:info@WarmlyYours.com).

# The Radiant Floor Heating Quote Builder

---

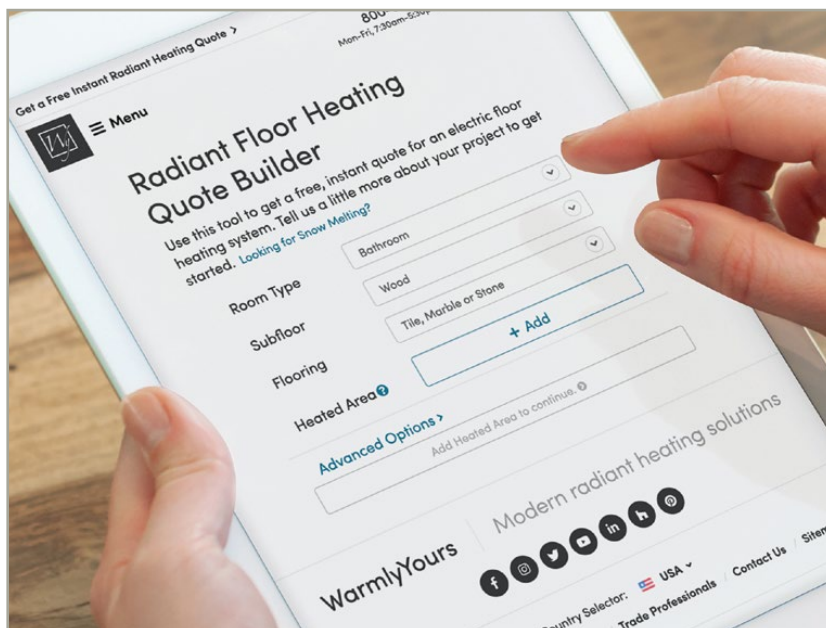

WarmlyYours has always been at the forefront of radiant heating technology. We were the first company to develop an online quotation tool for radiant heating products because we had both the expertise and the drive to empower our customers during the buying process.

Our Radiant Floor Heating Quote Builder represents the culmination of decades of experience and know-how that has been

condensed into an easy-to-use option for getting free and instant floor heating quotes online.

By simply providing a few project details, you'll be presented with a side-by-side comparison, complete with pricing and product information, of the heating systems that will work with your project.

From there, you can purchase the system directly or get a free SmartPlan™ installation plan by either uploading a project sketch or by using our online Design Tool.

Check it out for yourself by going to [www.warmlyyours.com/quote](http://www.warmlyyours.com/quote)

# The WarmlyYours Design Tool

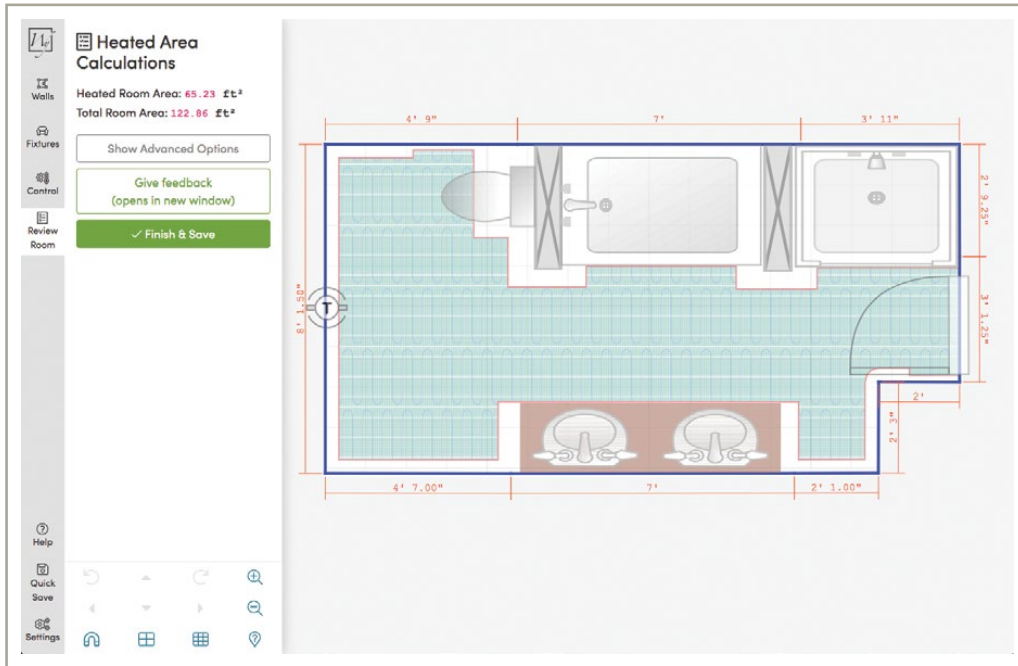

Our Design Tool is the only one of its kind in the industry. Not everyone is comfortable drawing a floor plan or project sketch but with our tool you can take out the guesswork. In just a few clicks, you can "draw" your project to scale and add a variety of different furnishings.

The Design Tool is a part of our Quote Builder. Once you've created your room, you can then save it to your quote in the Quote Builder. From there, you'll can build your floor heating system based on your drawing or you can request a custom SmartPlan™ installation plan from our team of skilled engineers.

Then you can also use the "Share this quote" function to generate a unique URL that will allow you to send your project to anyone.

Features of the Design Tool:

- Allows you to create a digital version of your project in real time
- Intuitive menu-based and drag-and-drop controls throughout the tool
- A variety of pre-loaded room shapes are available for you to choose from
- Can be saved to your quote and shared via a generated URL
- A wide range of furnishings can be added to your room for extra accuracy

# TempZone™ Custom Mats

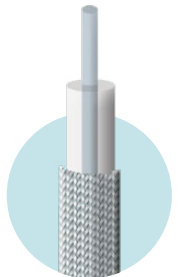

Single Conductor

TempZone™ Custom Mats are designed for use under some of the most commonly heated flooring types like tile and marble. These mats are custom built for each project. Because they are the exact size and shape needed for the room, they provide the easiest level of installation for floor heating systems. They also provide a superior level of heating coverage for rooms that have non-linear design elements like sharp angles or curves.

TempZone™ Custom Mats are constructed so that the heating element is sandwiched between two layers of fabric which lends a degree of additional durability during the installation process.

- Full coverage for any size space, such as bathrooms, kitchens, living rooms or basements
- Easiest installation, no cut and turns required
- Customized, perfect fit for your specific room design
- 12-15 watts per square foot, 1/8" thick
- Circuit Check available to ensure fault-free installation
- ETL Listed

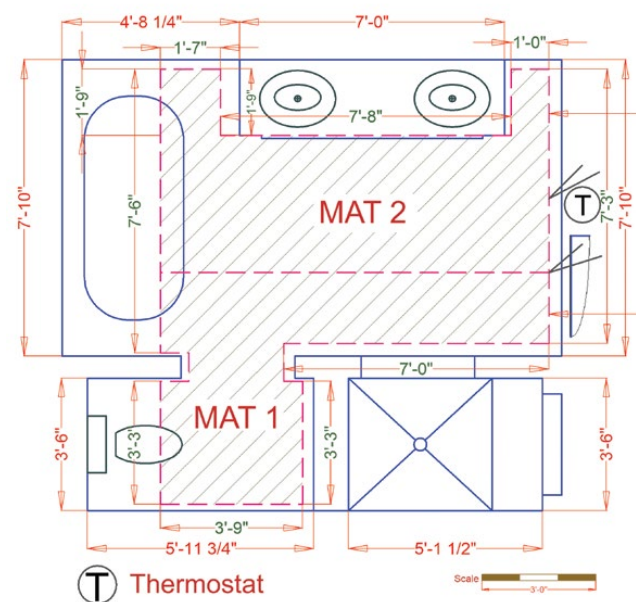
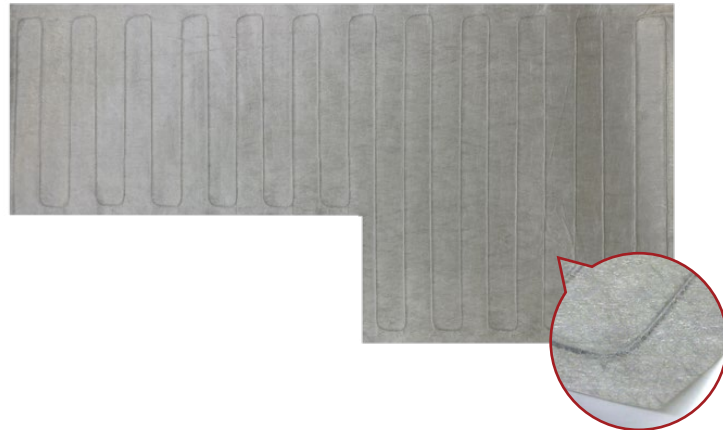



# TempZone™

## Custom Mats

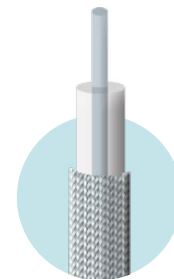

Single Conductor

## How To Order

The TempZone™ Custom Mats are tailored to perfectly fit the exact dimensions of your room. Because these are custom, made-to-order mats, they are not available for direct order online. So we thought we'd provide you with a few steps that we recommend to help you purchase and begin enjoying your floor heating as soon as possible.

### Step 1

#### Call a WarmlyYours Sales Representative

The first step is to contact a representative, who will provide expert support throughout the process. Call us today at (800) 875-5285.

### Step 2

#### Accurately Measure the Space

To ensure optimal fit for your custom mat, be sure to have accurate measurements of the room you want to heat. If you have any questions about how to measure a room for floor heating, give our Installation Support team a call at (800) 875-5285.

### Step 3

#### Get an Installation Plan and Free Quote

Once you have completed your measurements and sent them to your WarmlyYours rep, we'll send those measurements to our skilled engineers, who will create a customized installation SmartPlan™ with a free, no obligation quote for your TempZone™ Custom Mat.

### Step 4

#### Place Your Order

After receiving the measurements and SmartPlan™, it's time to place your order. For our custom mats, expect 8 to 10 business days, plus shipping time, for design and production of your mat.

# TempZone™ Flex Rolls

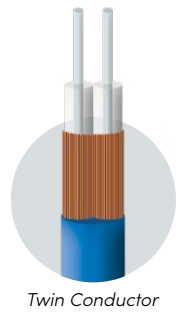

TempZone™ Flex Rolls were designed to provide full coverage heating while making installation as easy and straight forward as possible. These twin-conductor rolls can be installed using the expedient “cut-and-turn” method which is perfect for traditional room shapes.

The evenly spaced, 3” serpentine loop design delivers more heating capacity and faster floor warm-ups than most competitive systems. At less than 1/8” thick, TempZone™ Flex Rolls install easily under tile, stone, marble or LVT flooring without significantly increasing floor height.

- Our most popular floor heating product
- Its cut-and-turn installation method is fast and easy
- Provides a heat output of 15-watts per sq. ft.
- Only 1/8” thick, so minimal impact on floor height
- Uses an energy efficient, twin conductor heating cable
- Covered by our unbeatable 25-year No Nonsense™ Warranty
- Wet Location and UL Listed for both US and Canada
- Circuit Check available to ensure fault-free installation

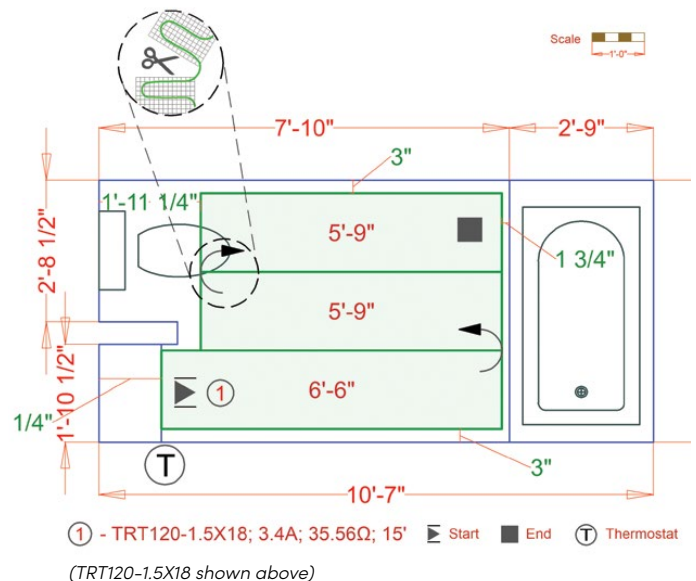
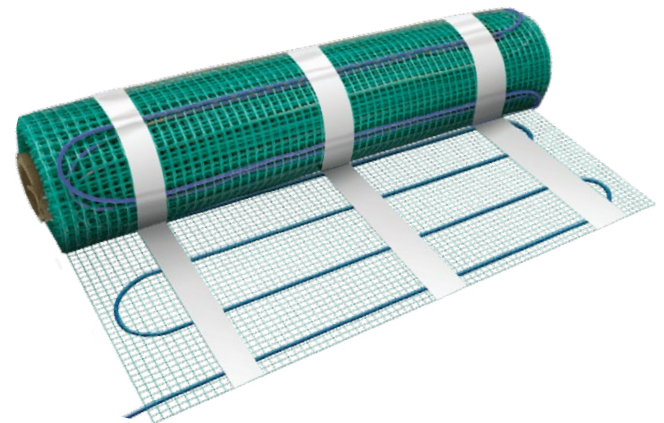

## 120 Volt TEMPZONE™ Flex Rolls

For tile, stone and hardwood floor warming applications

CODE	DIMENSIONS	SQ.FT.	WATTS	AMPS	MSRP
TRT120-1.5x04	1.5' x 4'	6.0	90	0.80	\$96.00
TRT120-1.5x06	1.5' x 6'	9.0	135	1.20	\$135.00
TRT120-1.5x09	1.5' x 9'	13.5	203	1.70	\$229.50
TRT120-1.5x12	1.5' x 12'	18.0	270	2.30	\$234.00
TRT120-1.5x15	1.5' x 15'	22.5	338	2.90	\$337.50
TRT120-1.5x18	1.5' x 18'	27.0	405	3.40	\$364.50
TRT120-1.5x21	1.5' x 21'	31.5	473	4.00	\$393.75
TRT120-1.5x24	1.5' x 24'	36.0	540	4.50	\$432.00
TRT120-1.5x27	1.5' x 27'	40.5	608	5.10	\$486.00
TRT120-1.5x30	1.5' x 30'	45.0	675	5.70	\$517.50
TRT120-1.5x33	1.5' x 33'	49.5	743	6.20	\$544.50
TRT120-1.5x38	1.5' x 38'	57.0	855	7.20	\$598.50
TRT120-1.5x43	1.5' x 43'	64.5	968	8.10	\$645.00
TRT120-1.5x48	1.5' x 48'	72.0	1,080	9.00	\$720.00
TRT120-1.5x52	1.5' x 52'	78.0	1,170	9.80	\$741.00
TRT120-1.5x56	1.5' x 56'	84.0	1,260	10.50	\$798.00
TRT120-1.5x60	1.5' x 60'	90.0	1,350	11.25	\$855.00
TRT120-1.5x66	1.5' x 66'	99.0	1,485	12.38	\$940.00
TRT120-1.5x70	1.5' x 70'	105.0	1,575	13.13	\$945.00

## 240 Volt TEMPZONE™ Flex Rolls

For tile, stone and hardwood floor warming applications

CODE	DIMENSIONS	SQ.FT.	WATTS	AMPS	MSRP
TRT240-1.5x8	1.5' x 8'	12.0	180	0.80	\$210.00
TRT240-1.5x14	1.5' x 14'	21.0	315	1.40	\$316.00
TRT240-1.5x17	1.5' x 17'	25.5	383	1.60	\$347.00
TRT240-1.5x22	1.5' x 22'	33.0	495	2.10	\$386.00
TRT240-1.5x29	1.5' x 29'	43.5	653	2.80	\$499.00
TRT240-1.5x36	1.5' x 36'	54.0	810	3.40	\$594.00
TRT240-1.5x42	1.5' x 42'	63.0	945	4.00	\$630.00
TRT240-1.5x46	1.5' x 46'	69.0	1,035	4.40	\$690.00
TRT240-1.5x49	1.5' x 49'	73.5	1,103	4.60	\$735.00
TRT240-1.5x54	1.5' x 54'	81.0	1,215	5.10	\$769.50
TRT240-1.5x57	1.5' x 57'	85.5	1,283	5.35	\$812.25
TRT240-1.5x66	1.5' x 66'	99.0	1,485	6.20	\$940.50
TRT240-1.5x76	1.5' x 76'	114.0	1,710	7.20	\$1,026.00
TRT240-3.0x43	3.0' x 43'	129.0	1,935	8.10	\$1,161.00
TRT240-3.0x48	3.0' x 48'	144.0	2,160	9.00	\$1,224.00
TRT240-3.0x52	3.0' x 52'	156.0	2,340	9.80	\$1,326.00
TRT240-3.0x60	3.0' x 60'	180.0	2,700	11.25	\$1,530.00
TRT240-3.0x70	3.0' x 70'	210.0	3,150	13.13	\$1,680.00

Pricing subject to change, because life happens.

# TempZone™

## Easy Mats

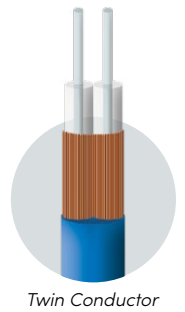

TempZone™ Easy Mats are used to provide targeted “spot heating” in high-traffic areas under tile, stone, marble or LVT flooring. Heating only the areas you use most helps to cut down on both material and operating costs without sacrificing comfort.

These twin-conductor mats are easy to install as they require no cutting— simply unroll it, attach it onto the subfloor, embed it in adhesive (thinset or self-leveling cement), and finally install the floor covering. Popular locations for TempZone™ Easy Mats are often bathrooms, kitchens, and foyers.

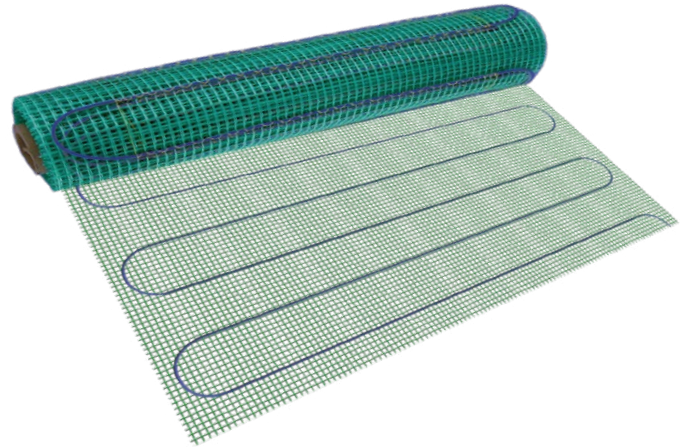

- Excellent option for targeted spot-heating
- Easy set-and-go installation method
- Heat output of 15-watts per sq. ft.
- 1/8” thickness won’t significantly increase floor height
- The heating cable is twin conductor and energy efficient
- Covered by our unbeatable 25-year No Nonsense™ Warranty
- Wet Location and UL Listed for both US and Canada
- Circuit Check available to ensure fault-free installation

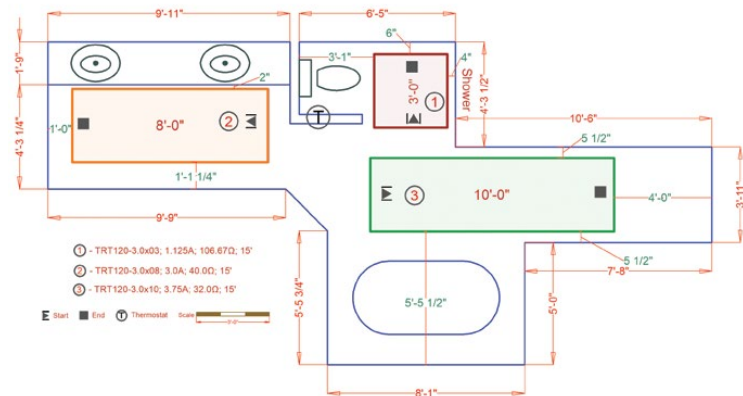

(TRT120-3x3, TRT120-3X8 and TRT120-3X10 shown above)

Spot heating is the use of an electric floor warming mat to only heat a specific area. This targeted heating method is extremely cost effective as it cuts down on installation time, material costs, and recurring operation costs—all while providing a high degree of comfort and luxury for the homeowner.

TempZone™ Easy Mats have been purpose-built for this type of heating and are a great option for rooms where foot traffic will be largely limited to a specific space.

**120 Volt TEMPZONE™ Easy Mat**  
For tile and stone floor warming applications

CODE	DIMENSIONS	SQ.FT.	WATTS	AMPS	MSRP
TRT120-3.0x02	3' x 2'	6.0	90	0.75	\$120.00
TRT120-3.0x03	3' x 3'	9.0	135	1.13	\$135.00
TRT120-3.0x05	3' x 5'	15.0	225	1.88	\$165.00
TRT120-3.0x06	3' x 6'	18.0	270	2.25	\$234.00
TRT120-3.0x08	3' x 8'	24.0	360	3.00	\$276.00
TRT120-3.0x10	3' x 10'	30.0	450	3.75	\$300.00

*Pricing subject to change, because life happens.*

# TempZone™

## Floor Heating Cable

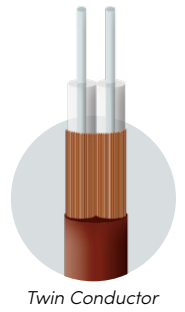

TempZone™ Floor Heating Cable brings radiant warmth and comfort to any room. This free-form cable provides the ultimate in flexibility, making it easy to customize installation for rooms of any size and shape.

The cable can be installed with either Fixing Strips or the Prodeso Cable Installation Membrane. The Fixing Strips are more economical but also more labor intensive while the membrane provides long-lasting uncoupling benefits for tile or stone floors.

- Can be installed with either fixing strips or the Prodeso Membrane
- Installation with the membrane is faster and provides uncoupling benefits
- Installation with fixing strips is more economical and provides more design flexibility
- The energy efficient cable outputs 3.7-watts per linear foot
- Twin conductor cable with a thickness of 3/16"
- Heat output of between 9 to 15-watts/sq. ft., depending on spacing
- Covered by our unbeatable 25-year No Nonsense™ Warranty
- Wet Location and UL Listed for both US and Canada
- Circuit Check available to ensure fault-free installation

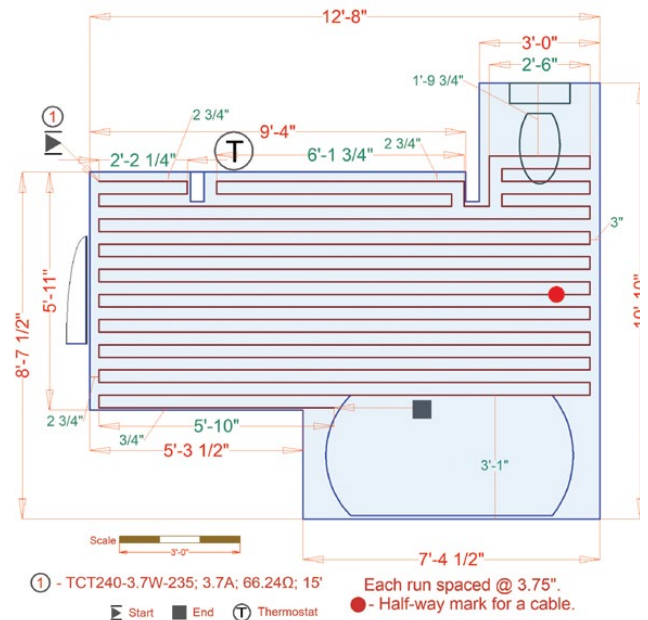
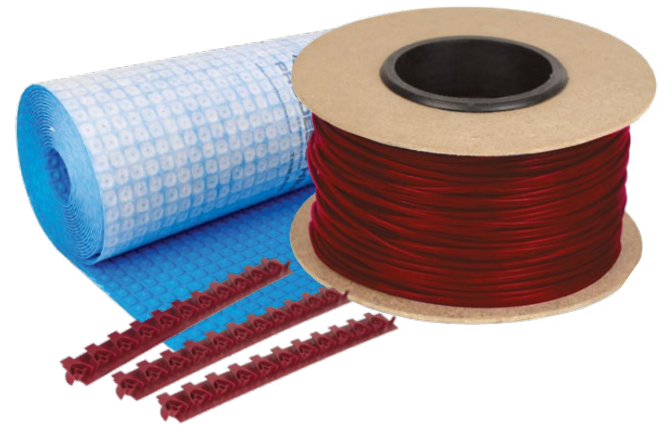

(TCT1240-3.7W-235 shown above)

## 120 Volt TEMPZONE™ Floor Heating Cables (Twin)

For tile, stone and hardwood floor warming applications

CODE	Cable length in feet	Coverage							WATTS	AMPS	MSRP
		3" spacing		3.5" spacing	3.75" spacing	4" spacing		5" spacing			
		Fixing Strips Only	Fixing Strips Needed	Competitor's Membrane	Prodeso Membrane Only	Fixing Strips Only	Fixing Strips Needed	Both Strips and Membrane			
TCT120-3.7W-030	30	7.5	9	8.8	9.3	9.9	12	12.5	111.0	1.0	\$115.79
TCT120-3.7W-040	40	10	12	11.7	12.5	13.3	12	16.6	148.0	1.3	\$142.11
TCT120-3.7W-050	50	12.5	12	14.6	15.6	16.6	20	20.8	185.0	1.6	\$163.16
TCT120-3.7W-070	70	17.5	20	20.4	21.8	23.3	20	29.1	259.0	2.2	\$194.74
TCT120-3.7W-090	90	22.5	20	26.3	28.1	29.9	24	37.5	333.0	2.8	\$236.84
TCT120-3.7W-120	120	30	24	35.0	37.5	39.9	35	50	444.0	3.7	\$278.95
TCT120-3.7W-150	150	37.5	35	43.8	46.8	49.9	40	62.5	555.0	4.7	\$331.58
TCT120-3.7W-180	180	45	35	52.5	56.2	59.9	48	75	666.0	5.6	\$368.42
TCT120-3.7W-220	220	55	48	64.2	68.7	73.3	54	91.6	814.0	6.8	\$421.05
TCT120-3.7W-260	260	65	54	75.8	81.2	86.6	70	108.3	962.0	8.1	\$463.16
TCT120-3.7W-300	300	75	54	87.5	93.7	99.9	77	125	1,110.0	9.3	\$500.00
TCT120-3.7W-340	340	85	70	99.2	106.2	113.3	88	141.6	1,258.0	10.5	\$536.84
TCT120-3.7W-375	375	93.7	70	109.4	117.1	124.9	96	156.2	1,388.0	11.6	\$573.68
TCT120-3.7W-432	432	108	77	126.0	135	143.9	104	180	1,598.0	13.4	\$636.84

## 240 Volt TEMPZONE™ Floor Heating Cables (Twin)

For tile, stone and hardwood floor warming applications

CODE	Cable length in feet	Coverage							WATTS	AMPS	MSRP
		3" spacing		3.5" spacing	3.75" spacing	4" spacing		5" spacing			
		Fixing Strips Only	Fixing Strips Needed	Competitor's Membrane	Prodeso Membrane Only	Fixing Strips Only	Fixing Strips Needed	Both Strips and Membrane			
TCT240-3.7W-055	55	13.7	12	16.0	17.1	18.3	20	22.9	204.0	0.9	\$168.42
TCT240-3.7W-065	65	16.2	20	19.0	20.3	21.6	20	27	241.0	1.1	\$189.47
TCT240-3.7W-075	75	18.7	20	21.9	23.4	24.9	24	31.2	278.0	1.2	\$205.26
TCT240-3.7W-095	95	23.7	24	27.7	29.6	31.6	30	39.5	352.0	1.5	\$242.11
TCT240-3.7W-115	115	28.7	24	33.5	35.9	38.3	35	47.9	426.0	1.8	\$273.68
TCT240-3.7W-155	155	38.7	35	45.2	48.4	51.6	48	64.5	574.0	2.4	\$336.84
TCT240-3.7W-195	195	48.7	40	56.9	60.9	64.9	54	81.2	722.0	3.1	\$389.47
TCT240-3.7W-235	235	58.7	48	68.5	73.4	78.3	70	97.9	870.0	3.7	\$436.84
TCT240-3.7W-275	275	68.7	54	80.2	85.9	91.6	70	114.5	1,018.0	4.3	\$478.95
TCT240-3.7W-315	315	78.7	70	91.9	98.4	104.9	77	131.2	1,166.0	4.9	\$515.79
TCT240-3.7W-355	355	88.7	70	103.5	110.9	118.3	88	147.9	1,314.0	5.5	\$552.63
TCT240-3.7W-395	395	98.7	77	115.2	123.4	131.6	96	164.5	1,462.0	6.1	\$594.74
TCT240-3.7W-435	435	108.7	77	126.9	135.9	144.9	104	181.2	1,610.0	6.8	\$636.84
TCT240-3.7W-515	515	128.7	96	150.2	160.9	171.6	126	214.6	1,906.0	8.0	\$715.79
TCT240-3.7W-595	595	148.7	117	173.5	185.9	198.3	150	247.9	2,202.0	9.2	\$800.00
TCT240-3.7W-675	675	168.7	126	196.9	210.9	224.9	160	281.2	2,498.0	10.5	\$884.21
TCT240-3.7W-749	749	187.2	126	218.5	234	249.6	176	312.1	2,771.0	11.6	\$957.89
TCT240-3.7W-864	864	216	150	252.0	270	287.9	198	360	3,197.0	13.4	\$1,042.11

Pricing subject to change, because life happens.

# TempZone™

## Shower Floor & Bench Mats

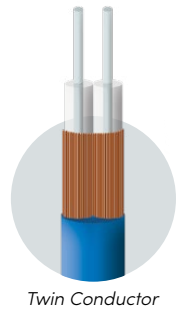

Tiled showers are growing in popularity due to the elegant possibilities that they open for bathroom design projects. Whether you're installing a traditional tiled shower, a curbless shower, or an entire wet room, radiant heating can help make these beautiful installations feel as good as they look.

Our TempZone™ Shower Mats and Shower Bench Mats are a great option for these applications. Both products are easy to install in either a tiled shower floor or a tiled shower bench.

- Bench Mats are used to warm tiled shower benches
- Shower Mats are used to warm the area around a tiled shower's drain
- Shower Mats come with an integrated drain hole
- Simple installation, no cutting required
- Shower Mats and Bench Mats provide 15-watts per sq. ft.
- Heating element thickness is only 1/8"
- Covered by our unbeatable 25-year No Nonsense™ Warranty
- Wet Location and UL Listed for both US and Canada
- Circuit Check available to ensure fault-free installation

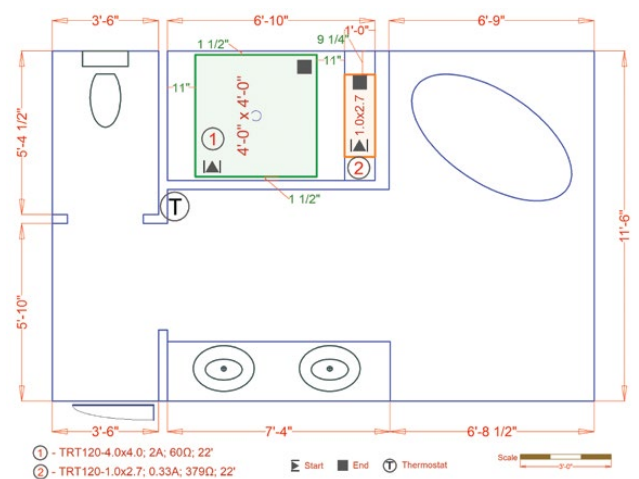
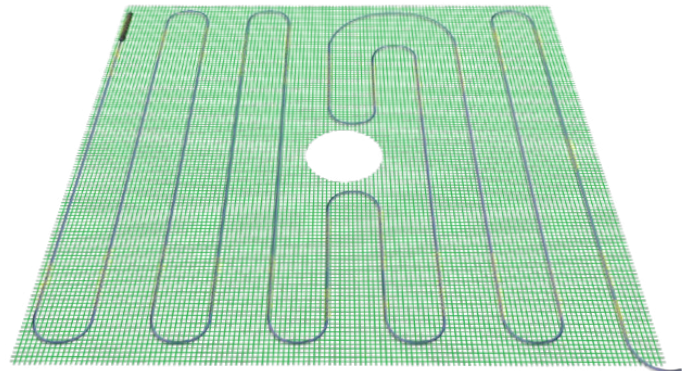

(TRT120-3x5 shown above)



The TempZone™ Shower Bench Mats guarantee that the time spent in your shower will be warm and relaxing. The Shower Bench Mats are configured to fit the slim design of shower benches. Each size is smartly designed to cover a standard bench width and length.

TempZone™ Shower Bench Mats For tile and stone floor warming applications						
CODE	WIDTH	LENGTH	SQ.FT.	WATTS	AMPS	MSRP
TRT120-1.0x2.7	11.5"	32.0"	2.6	39	0.33	\$81.00
TRT120-1.3x2.7	16.0"	32.0"	3.6	54	0.45	\$101.00

TempZone™ Shower Mats have been exclusively designed to provide warmth for two areas in the shower: the floor and shower bench. TempZone™ Shower Floor Mats ensure that the first step into your shower is a warm and soothing experience. The Shower Floor Mats are engineered to cover traditional shower floor areas with allowance for the shower drain. Each Shower Floor Mat is designed with a wire-free drain for fast and easy installation. Now that's smart.

TempZone™ Shower Floor Mats For tile and stone floor warming applications						
CODE	WIDTH	LENGTH	SQ.FT.	WATTS	AMPS	MSRP
TRT120-2.7x2.7	32.0"	32.0"	7.1	107	0.89	\$135.00
TRT120-2.7x5.0	32.0"	60.0"	13.3	200	1.67	\$226.00
TRT120-4.0x4.0	48.0"	48.0"	16.0	240	2.00	\$256.00

*Pricing subject to change, because life happens.*

BRAND NEW!

The first floor heating and shower waterproofing kits on the market

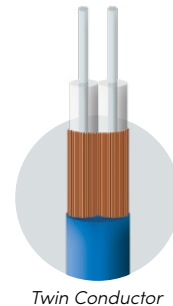

# PRO Gen II

## Shower Waterproofing & Floor Heating Kits

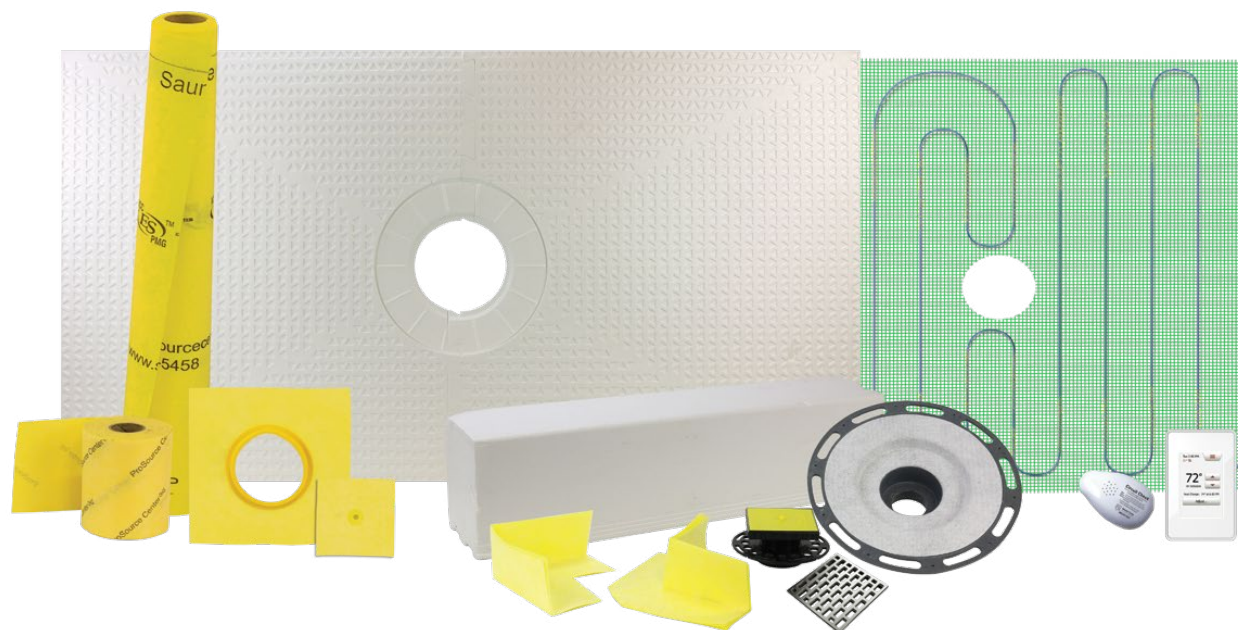

These kits, only available from WarmlyYours, come with nearly everything you'll need for a successful installation of both a waterproofing system and a floor heating system for a tile shower.

### A complete kit will include:

- TempZone™ Floor Heating Shower Mat
- Circuit Check™ Electrical Continuity Alarm
- nSpire Touch Programmable Floor Heating Thermostat
- Pro GEN II Shower Pan
- Pro GEN II Drain Assembly (in PVC or ABS) with Integrated Hair Trap
- Pro WP Waterproofing Membrane (Large Rolls)
- Pro WP Waterproofing Membrane Joint Strip
- Pro WP Waterproofing Membrane Preformed Inside Corners (4x)
- Pro WP Waterproofing Membrane Preformed Outside Corners (2x)
- Pro WP Waterproofing Mixing Valve Seal
- Pro WP Waterproofing Pipe Seal
- Screw-less Pro Series Grate Cover and Grate Puller Key
- Solid Polystyrene Shower Curb

For the very first time, waterproofing kits can be combined with electric floor heating kits to create the ultimate combination of luxury and ease of installation. The high quality components of these kits ensure that the installation process will be straightforward, fast, and safe. The Pro GEN II shower drain assembly includes many great features such as an easy-to-clean, integrated hair trap and multiple available grate cover options. And, of course, the TempZone™ Shower Mat will provide reliable and energy efficient radiant heat to take the chill off a tile floor.

The shower waterproofing materials come with a lifetime limited warranty and the floor heating elements are covered by our 25-year No Nonsense™ Warranty.

#### Features:

- Integrated hair trap and screw-less grate cover make cleaning and maintenance easy
- Whereas traditional mud beds will function as "heatsinks", the Pro GEN II shower pan's R-value serves as a thermal break under the heating system to prevent heat loss
- The robust Pro GEN II shower drain flange is rated at 780 PSI vs. the competition's rating of 250 PSI and the Pro GEN II shower pan has a 3.5 lb/ft<sup>3</sup> density vs. the competition's density
- The shower pan and heating element have matching drain holes for set-and-go installation
- The built-in slope of the shower pan eliminates the need for a mud/mortar bed
- The heating element provides a heat output of 15-watts per square foot
- The floor heating element is cULus listed and is approved for "Wet Locations" by UL
- The floor heating kit comes with a programmable thermostat to maximize energy efficiency
- Available with either PVC or ABS drain flanges for proper plumbing connection

## Now you can build your own floor heating and shower waterproofing kit:

#### Shower Pan/Heating Element Size and Drain Orientation:

- 48" x 48" with Centered Drain
- 32" x 60" with Centered Drain
- 32" x 60" with Offset Drain

#### Drain Flange Material:

- PVC
- ABS

#### Drain Grate Covers

##### Pro Series:

An affordable option with a brick pattern design and 8 available finishes: Polished Chrome

- Brushed Nickel
- Oil Rubbed Bronze
- Polished Black
- Antique Brass
- Matte Black
- Copper

##### Designer Series:

A luxuriant 304 stainless steel option in either polished or brushed finishes and 9 different patterns:

- Asterix
- Pebbles
- Bubbles
- Ripples
- Destil
- Swirl
- Lattice
- Waves
- Obelix

## Shower Pan Kits

CODE	Description	MSRP
SH-272446	Pro GEN II 48" x 48" Tile Waterproofing Shower Pan Kit with Center Drain Hole	\$419.00
SH-272455	Pro GEN II 32" x 60" Tile Waterproofing Shower Pan Kit with Offset Drain Hole	\$519.00
SH-272472	Pro GEN II 32" x 60" Tile Waterproofing Shower Pan Kit with Center Drain Hole	\$519.00



Waterproofing Shower Pan Kit includes a Shower Pan, Waterproofing Membrane, Waterproofing Band, and Polystyrene Curbs

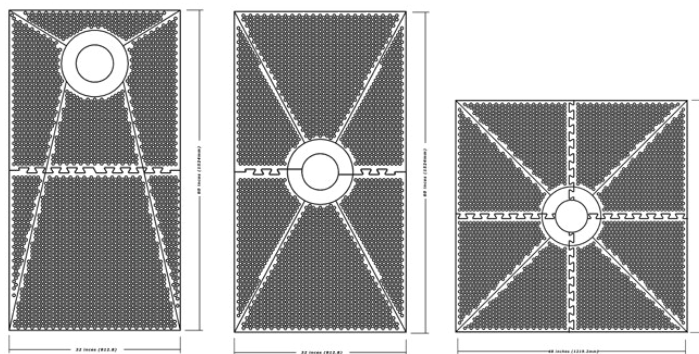

32" x 60" Offset Drain

32" x 60" Center Drain

48" x 48" Center Drain

## Shower Drain Assembly Kits

CODE	Description	MSRP
SH-270077-Pack	Pro GEN II Shower Drain Assembly Kit - PVC Flange	\$90.00
SH-270078-Pack	Pro GEN II Shower Drain Assembly Kit - ABS Flange	\$90.00

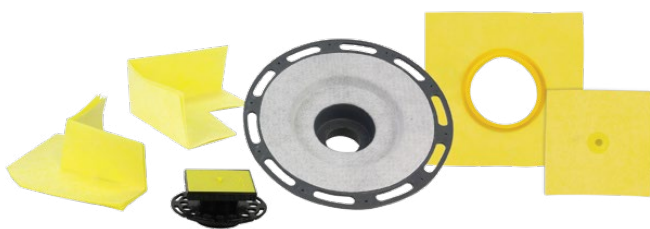

Shower Drain Assembly Kit includes Shower Drain Assembly, Waterproofing Mixing Valve Seal, Waterproofing Pipe Seal, and Waterproofing Inside and Outside Corners

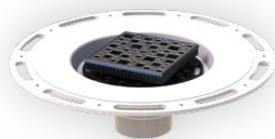

PVC Drain Assembly



ABS Drain Assembly

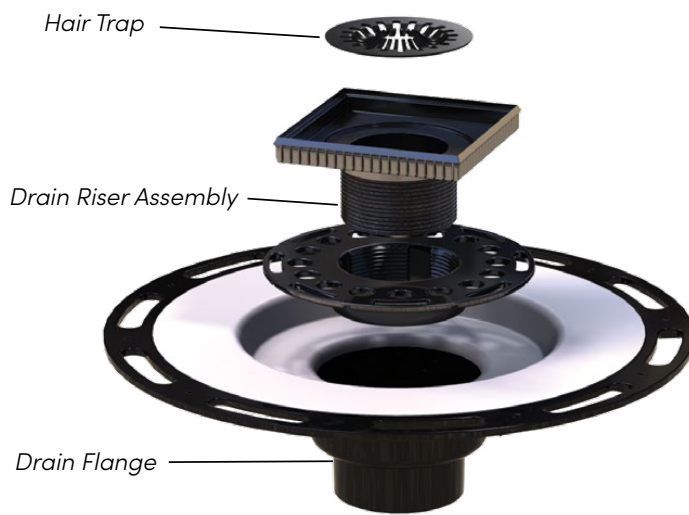

## Shower Floor Heating Kits

CODE	Description	MSRP
TRT120-KIT-OT-2.7x5.0	TempZone Electric Shower Floor Heating Kit - 32" x 60" - Center Drain	\$299.00
TRT120-KIT-OT-2.705.0	TempZone Electric Shower Floor Heating Kit - 32" x 60" - Offset Drain	\$299.00
TRT120-KIT-OT-4.0x4.0	TempZone Electric Shower Floor Heating Kit - 48" x 48" - Center Drain	\$309.00

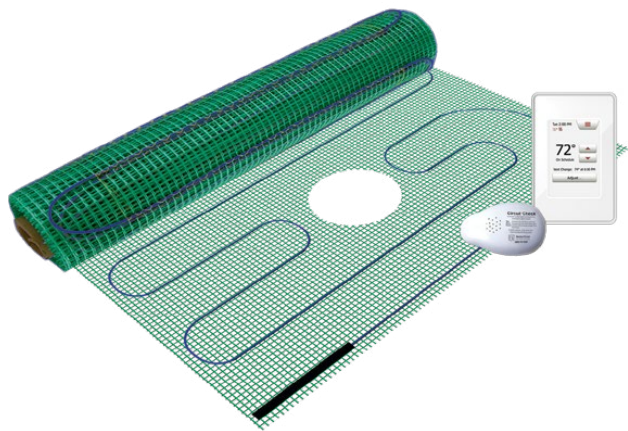

TempZone Electric Shower Floor Heating Kit includes a TempZone Electric Shower Floor Heating Mat, Circuit Check, and Programmable Thermostat

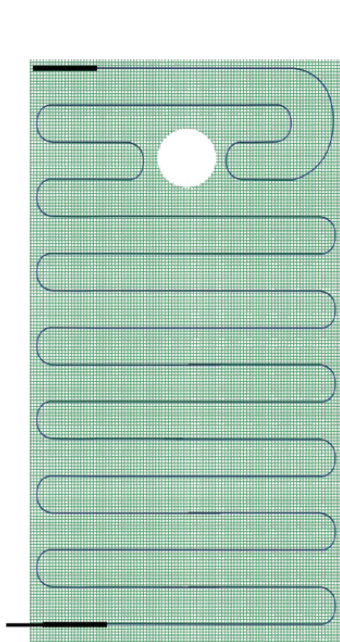
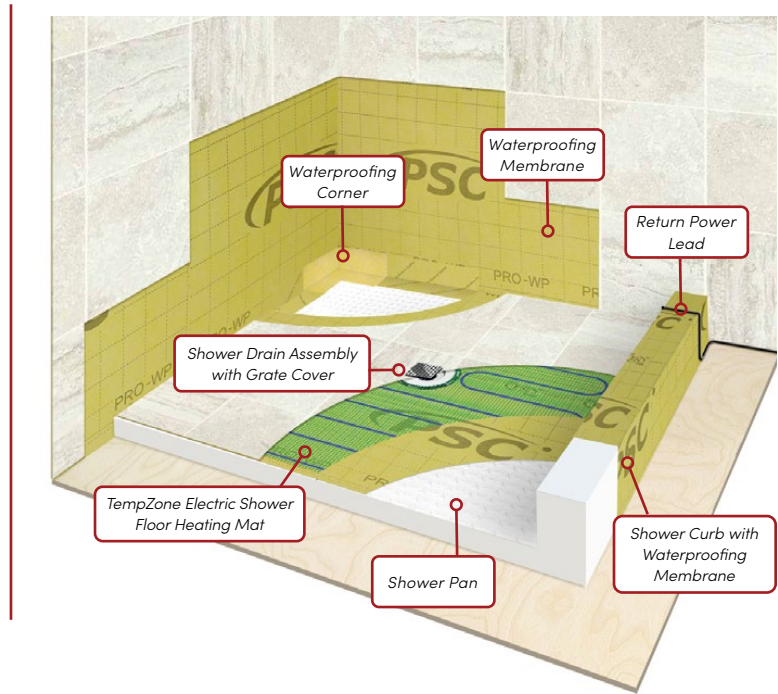

32" x 60" Offset Drain

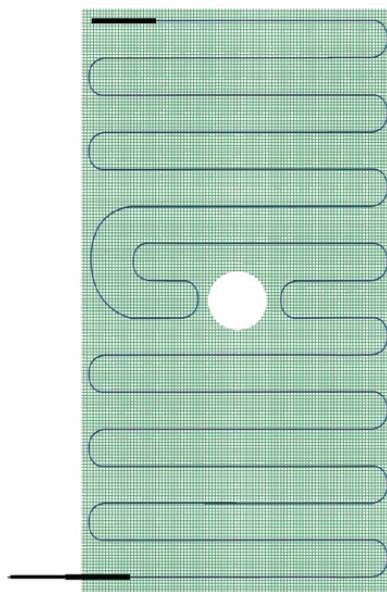

32" x 60" Center Drain

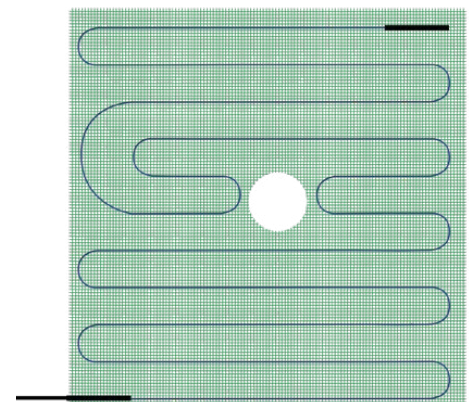

48" x 48" Center Drain

## Drain Grate Covers

CODE	Description	MSRP
<b>Pro Series</b>		
SH-271797	Pro GEN II Grate Cover, Pro Series Brick Pattern, Antique Brass Finish	\$28.00
SH-271339	Pro GEN II Grate Cover, Pro Series Brick Pattern, Brushed Nickel Finish	\$28.00
SH-271336	Pro GEN II Grate Cover, Pro Series Brick Pattern, Copper Finish	\$28.00
SH-271341	Pro GEN II Grate Cover, Pro Series Brick Pattern, Matte Black Finish	\$28.00
SH-271342	Pro GEN II Grate Cover, Pro Series Brick Pattern, Oil-rubbed Bronze Finish	\$28.00
SH-271340	Pro GEN II Grate Cover, Pro Series Brick Pattern, Polished Black Finish	\$28.00
SH-271337	Pro GEN II Grate Cover, Pro Series Brick Pattern, Polished Chrome Finish	\$28.00
<b>Designer Series (Brushed)</b>		
SH-271332	Pro GEN II Grate Cover, Designer Series Asterix Pattern, Brushed Stainless Steel	\$105.00
SH-271328	Pro GEN II Grate Cover, Designer Series Bubbles Pattern, Brushed Stainless Steel	\$105.00
SH-271327	Pro GEN II Grate Cover, Designer Series Destil Pattern, Brushed Stainless Steel	\$105.00
SH-271333	Pro GEN II Grate Cover, Designer Series Lattice Pattern, Brushed Stainless Steel	\$105.00
SH-271331	Pro GEN II Grate Cover, Designer Series Obelix Pattern, Brushed Stainless Steel	\$105.00
SH-271334	Pro GEN II Grate Cover, Designer Series Pebbles Pattern, Brushed Stainless Steel	\$105.00
SH-271326	Pro GEN II Grate Cover, Designer Series Ripples Pattern, Brushed Stainless Steel	\$105.00
SH-271330	Pro GEN II Grate Cover, Designer Series Swirl Pattern, Brushed Stainless Steel	\$105.00
SH-271329	Pro GEN II Grate Cover, Designer Series Waves Pattern, Brushed Stainless Steel	\$105.00
<b>Designer Series (Polished)</b>		
SH-271380	Pro GEN II Grate Cover, Designer Series Asterix Pattern, Polished Stainless Steel	\$105.00
SH-271376	Pro GEN II Grate Cover, Designer Series Bubbles Pattern, Polished Stainless Steel	\$105.00
SH-271375	Pro GEN II Grate Cover, Designer Series Destil Pattern, Polished Stainless Steel	\$105.00
SH-271381	Pro GEN II Grate Cover, Designer Series Lattice Pattern, Polished Stainless Steel	\$105.00
SH-271379	Pro GEN II Grate Cover, Designer Series Obelix Pattern, Polished Stainless Steel	\$105.00
SH-271382	Pro GEN II Grate Cover, Designer Series Pebbles Pattern, Polished Stainless Steel	\$105.00
SH-271374	Pro GEN II Grate Cover, Designer Series Ripples Pattern, Polished Stainless Steel	\$105.00
SH-271378	Pro GEN II Grate Cover, Designer Series Swirl Pattern, Polished Stainless Steel	\$105.00
SH-271377	Pro GEN II Grate Cover, Designer Series Waves Pattern, Polished Stainless Steel	\$105.00

### Pro Series Finishes



Brick Pattern - Polished Chrome



Brick Pattern - Brushed Nickel



### Designer Series Patterns (Available with Brushed or Polished Finishes)

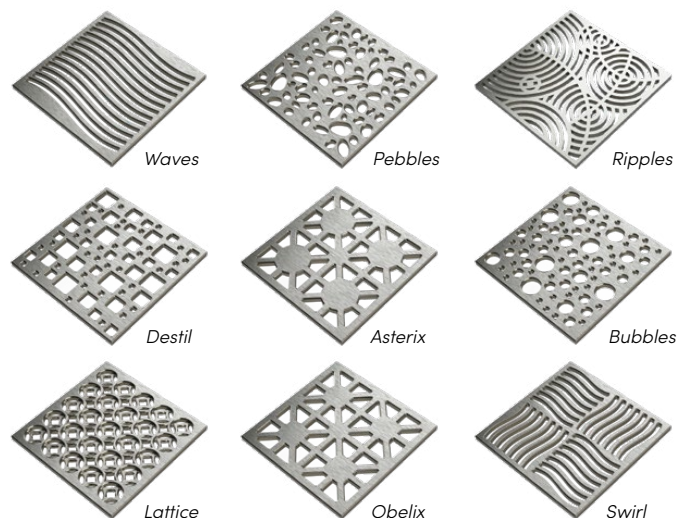

## Additional Items

CODE	Description	MSRP
SH-172094-108	Pro WP Waterproofing Membrane - 108 Sq. Ft. Roll - 39.5" x 33'	\$120.00
SH-172094-135	Pro WP Waterproofing Membrane - 135 Sq. Ft. Roll - 39.5" x 41'	\$150.00
SH-172094-216	Pro WP Waterproofing Membrane - 216 Sq. Ft. Roll - 39.5" x 66'	\$230.00
SH-172094-323	Pro WP Waterproofing Membrane - 323 Sq. Ft. Roll - 39.5" x 98.5'	\$300.00
SH-172097	Pro WP Waterproofing Inside Corner	\$4.50
SH-172098	Pro WP Waterproofing Outside Corner	\$4.50
SH-156278	Pro WP Waterproofing Pipe Seal	\$7.00
SH-269603	Pro WP Waterproofing Mixing Valve Seal	\$7.00
SH-265414	Pro WP Waterproofing Band 5" x 33'	\$34.00
SH-270060	Pro GEN II Hair Trap - 3" Diameter	\$1.95
SH-176652	Pro GEN II 48" x 48" Shower Pan with Center Drain Hole	\$85.00
SH-268431	Pro GEN II 32" x 60" Shower Pan with Center Drain Hole	\$115.00
SH-203271	Pro GEN II 32" x 60" Shower Pan with Offset Drain Hole	\$115.00
SH-271796	Pro GEN II Solid Polystyrene Shower Curb - 2' Long	\$30.00
SH-191421	Pro GEN II Solid Polystyrene Shower Curb - 3' Long	\$36.00
SH-246503	Pro GEN II Solid Polystyrene Shower Curb - 4' Long	\$40.00
SH-271798	Puller Key for Grate Covers	\$1.95
SH-270077	Pro GEN II Shower Drain Assembly - PVC Flange	\$59.00
SH-270078	Pro GEN II Shower Drain Assembly - ABS Flange	\$55.00



# Environ Flex Rolls

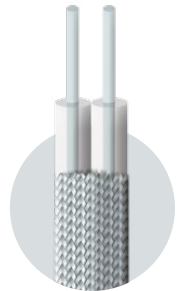

Twin Conductor

WarmlyYours was the first to introduce nonadhesive, foil, electric floor heating to the North American market, and we have over a decade of experience with this advanced design heating technology. At 12 watts per square foot, the energy-efficient Environ™ systems allow for gradual warming of delicate carpet and floating wood floor coverings.

The Environ™ Flex Rolls are flexible and specifically designed for easy installation under carpet, laminate or floating wood flooring. They can be cut and turned at 90° or 180° to provide thorough wall-to-wall coverage of larger spaces.

- Fast and easy installation with cut-and-turn method
- Ultra-thin construction (1/16") won't impact floor height
- Installs without adhesives which means big cost savings
- Provides a heat output of 12-watts per sq. ft.
- 10-year warranty under laminate or floating hardwood, 5-year under carpet (US Only)
- UL Listed in both the US and Canada
- Circuit Check available to ensure fault-free installation

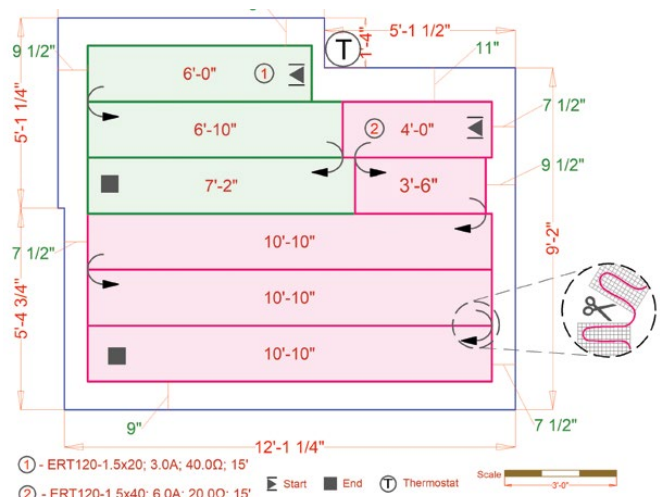

(ERT120-1.5X20 and ERT120-1.5X40 shown above)



## 120 Volt ENVIRON™ Flex Rolls

For carpet, floating wood, and laminate floor warming applications

CODE	WIDTH	LENGTH	SQ.FT.	WATTS	AMPS	MSRP
ERT120-1.5x06	1'6"	6'	9.0	108	0.90	\$108.00
ERT120-1.5x08	1'6"	8'	12.0	144	1.20	\$132.00
ERT120-1.5x10	1'6"	10'	15.0	180	1.50	\$165.00
ERT120-1.5x12	1'6"	12'	18.0	216	1.80	\$180.00
ERT120-1.5x14	1'6"	14'	21.0	252	2.10	\$210.00
ERT120-1.5x16	1'6"	16'	24.0	288	2.40	\$228.00
ERT120-1.5x18	1'6"	18'	27.0	324	2.70	\$257.00
ERT120-1.5x20	1'6"	20'	30.0	360	3.00	\$285.00
ERT120-1.5x25	1'6"	25'	37.5	450	3.75	\$356.00
ERT120-1.5x30	1'6"	30'	45.0	540	4.50	\$428.00
ERT120-1.5x35	1'6"	35'	52.5	630	5.25	\$473.00
ERT120-1.5x40	1'6"	40'	60.0	720	6.00	\$540.00
ERT120-1.5x45	1'6"	45'	67.5	810	6.75	\$608.00

*Environ™ Flex Rolls cannot be used under carpet in Canada. U.S. only.*

## 240 Volt ENVIRON™ Flex Rolls

For carpet, floating wood, and laminate floor warming applications

CODE	WIDTH	LENGTH	SQ.FT.	WATTS	AMPS	MSRP
ERT240-1.5x06	1'6"	6'	9.0	108	0.45	\$108.00
ERT240-1.5x08	1'6"	8'	12.0	144	0.60	\$132.00
ERT240-1.5x10	1'6"	10'	15.0	180	0.75	\$165.00
ERT240-1.5x14	1'6"	14'	21.0	252	1.05	\$210.00
ERT240-1.5x20	1'6"	20'	30.0	360	1.50	\$285.00
ERT240-1.5x25	1'6"	25'	37.5	450	1.88	\$356.00
ERT240-1.5x30	1'6"	30'	45.0	540	2.25	\$428.00
ERT240-1.5x35	1'6"	35'	52.5	630	2.63	\$473.00
ERT240-1.5x40	1'6"	40'	60.0	720	3.00	\$540.00
ERT240-1.5x45	1'6"	45'	67.5	810	3.38	\$608.00
ERT240-1.5x50	1'6"	50'	75.0	900	3.75	\$638.00
ERT240-1.5x60	1'6"	60'	90.0	1,080	4.50	\$765.00
ERT240-1.5x70	1'6"	70'	105.0	1,260	5.25	\$840.00
ERT240-1.5x80	1'6"	80'	120.0	1,440	6.00	\$960.00
ERT240-1.5x90	1'6"	90'	135.0	1,620	6.75	\$1,080.00

*Environ™ Flex Rolls cannot be used under carpet in Canada. U.S. only.*

*Pricing subject to change, because life happens.*

# Environ Easy Mats

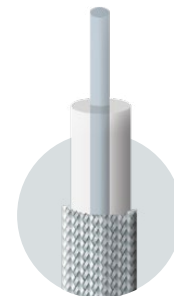

Single Conductor

Environ™ Easy Mats can simply be installed “as is”. No cutting or adhesives are required which saves in time and cost. They are available in a wide variety of rectangular sizes. These are a great option for targeted heating of high traffic areas and are often installed in bedrooms and living rooms.

The wafer thin mat installs directly between an underlayment pad and floor covering to heat the floor and provide even, comfortable warmth. Environ™ Easy Mats are often installed under carpet (U.S. only), laminate, or floating wood floors.

- Great for targeted spot-heating of high traffic areas
- Adhesive-less installation translates to less cost
- Minimal impact on floor height due to thin construction (1/16")
- Heat output of 12-watts per sq. ft.
- 10-year warranty under laminate or floating hardwood, 5-year under carpet (US Only)
- UL Listed in both the US and Canada
- Circuit Check available to ensure fault-free installation

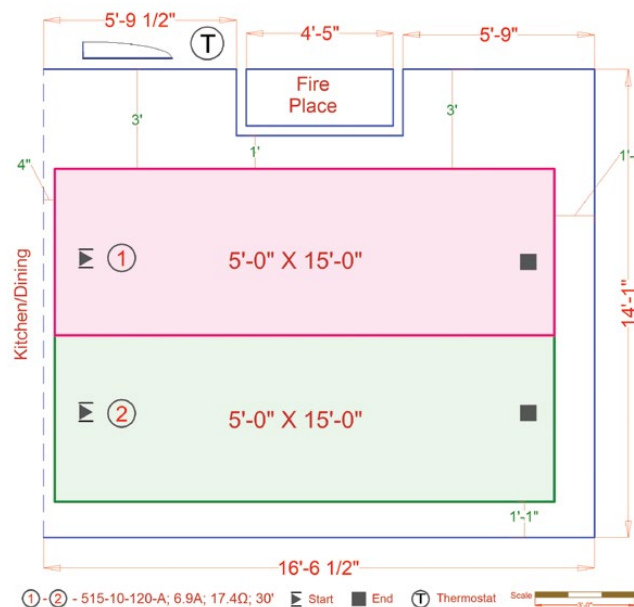
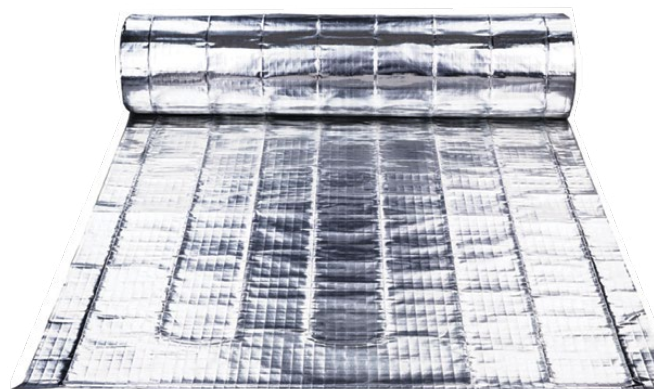

(510-10-120-A shown above)

## 120 Volt ENVIRON™ Easy Mats (Single Conductor)

For carpet, floating wood, and laminate floor warming applications

CODE	DIMENSIONS	SQ.FT.	WATTS	AMPS	MSRP
510-10-120	5' x 10' panel	50.0	583	4.86	\$500.00
515-10-120	5' x 15' panel	75.0	828	6.90	\$750.00
66-10-120	6' x 6' panel	36.0	457	3.81	\$360.00
610-10-120	6' x 10' panel	60.0	724	6.03	\$600.00

*Environ™ Easy Mats cannot be used under carpet in Canada. U.S. only.*

## 240 Volt ENVIRON™ Easy Mats (Single Conductor)

For carpet, floating wood, and laminate floor warming applications

CODE	DIMENSIONS	SQ.FT.	WATTS	AMPS	MSRP
510-10-240	5' x 10' panel	50.0	584	2.43	\$500.00
515-10-240	5' x 15' panel	75.0	873	3.64	\$750.00
66-10-240	6' x 6' panel	36.0	457	1.90	\$360.00
610-10-240	6' x 10' panel	60.0	753	3.14	\$600.00

*Environ™ Easy Mats cannot be used under carpet in Canada. U.S. only.*

## 120 Volt ENVIRON™ Easy Mats (Twin Conductor)

For carpet, floating wood, and laminate floor warming applications

CODE	DIMENSIONS	SQ.FT.	WATTS	AMPS	AMPS
ERT120-3.0x05	3' x 5' panel	15.0	180	1.50	\$165.00
ERT120-3.0x08	3' x 8' panel	24.0	288	2.40	\$240.00
ERT120-3.0x10	3' x 10' panel	30.0	360	3.00	\$300.00

*Environ™ Easy Mats cannot be used under carpet in Canada. U.S. only.*

*Pricing subject to change, because life happens.*

# Indoor Slab Heating Mats

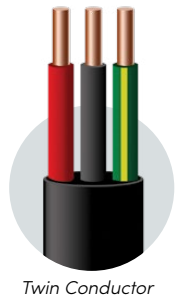

Slab Heating Mats offer yet another opportunity to enjoy radiant heat in a basement, garage, sunroom addition, or in any new-pour finished concrete floor. Our Slab Heating Mats warm naturally cold concrete efficiently and economically from within the slab itself. They are installed using the “cut-and-turn” method to achieve even heating.

Our Slab Heating Mats come in a range of sizes, so you’re sure to find the perfect fit for your project. And WarmlyYours engineers will design your Slab Heating system complete with recommended controls.

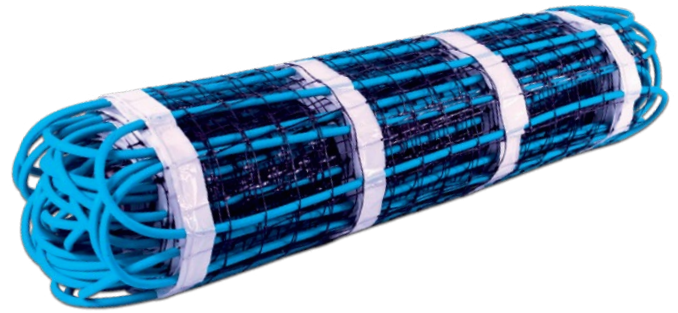

- These mats can be cut-and-turned for easy installation
- Embeds directly within a slab to radiate heat to the surface
- High heat output of nearly 20-watts per sq. ft.
- Consists of a 1/4” thick cable attached to a plastic mesh
- Covered by a 10-year warranty
- cCSAus Listed
- Circuit Check available to ensure fault-free installation

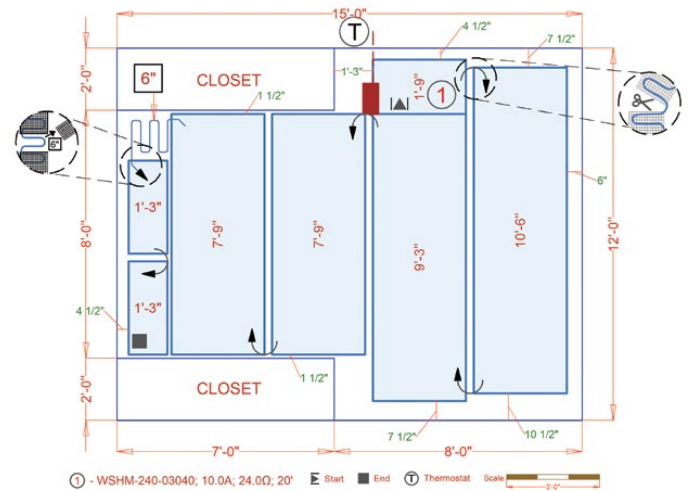

(WSHM-240-03040 shown above)

## 120 Volt INDOOR SLAB HEATING MATS

For installation in concrete

CODE	DIMENSIONS	SQ.FT.	WATTS	AMPS	MSRP
WSHM-120-15011	1.5' X 11'	16.5	330	2.75	\$240.00
WSHM-120-15016	1.5' X 16'	24.0	480	4.00	\$300.00
WSHM-120-15022	1.5' X 22'	33.0	660	5.50	\$360.00
WSHM-120-03017	3.0' X 17'	51.0	1,020	8.50	\$510.00
WSHM-120-15036	1.5' X 36'	54.0	1,080	9.00	\$530.00
WSHM-120-15040	1.5' X 40'	60.0	1,200	10.00	\$580.00
WSHM-120-03021	3.0' X 21'	63.0	1,260	10.50	\$600.00
WSHM-120-03025	3.0' X 25'	75.0	1,500	12.50	\$680.00
WSHM-120-15056	1.5' X 56'	84.0	1,680	14.00	\$750.00
WSHM-120-03029	3.0' X 29'	87.0	1,740	14.50	\$760.00

## 240 Volt INDOOR SLAB HEATING MATS

For installation in concrete

CODE	DIMENSIONS	SQ.FT.	WATTS	AMPS	MSRP
WSHM-240-15064	1.5' X 64'	96.0	1,920	8.00	\$790.00
WSHM-240-15070	1.5' X 70'	105.0	2,100	8.75	\$845.00
WSHM-240-03040	3.0' X 40'	120.0	2,400	10.00	\$950.00
WSHM-240-15085	1.5' X 85'	127.5	2,550	10.63	\$995.00
WSHM-240-03044	3.0' X 44'	132.0	2,640	11.00	\$1,000.00
WSHM-240-15095	1.5' X 95'	142.5	2,850	11.88	\$1,050.00
WSHM-240-03048	3.0' x 48'	144.0	2,880	12.00	\$1,060.00
WSHM-240-03052	3.0' x 52'	156.0	3,120	13.00	\$1,100.00
WSHM-240-15112	1.5' X 112'	168.0	3,360	14.00	\$1,150.00
WSHM-240-03056	3.0' X 56'	168.0	3,360	14.00	\$1,150.00

Pricing subject to change, because life happens.

# Indoor Slab Heating Cable

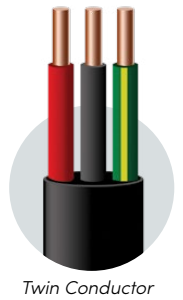

Electric Slab Heating Cables are an economical alternative to our Slab Heating Mats for installing in a new-pour concrete slab for heating basements, garages, or any finished concrete floor. They can be installed with the cable spaced at different intervals (3", 4", and 5"), which will change the wattage per square foot, depending on your floor warming needs.

Our cable product is priced lower than our mats but it does require more labor. Another benefit of Slab Heating Cables is that they can be used for maximum design flexibility to heat a variety of room shapes and sizes.

- Economical alternative to Slab Heating Mats
- Great for rounded or curved projects
- Delivers between 15 and 20-watts per sq. ft. depending on spacing
- 1/4" thick cables can be embedded in a slab to radiate heat to the surface
- Covered by a 10-year warranty
- cCSAus Listed
- Circuit Check available to ensure fault-free installation

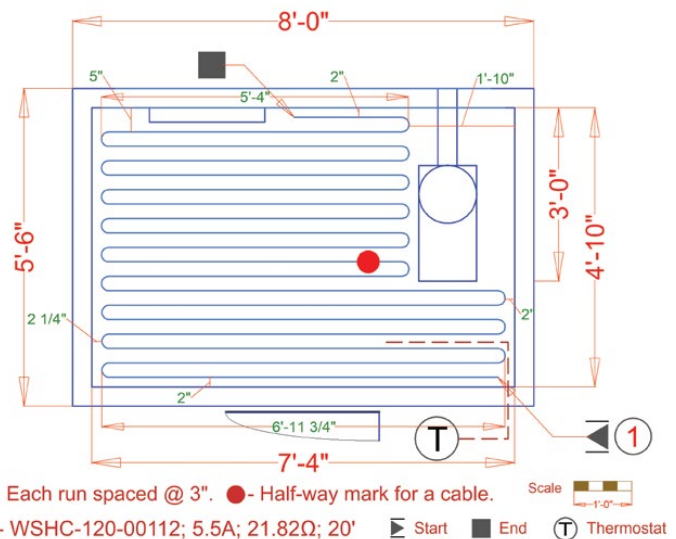
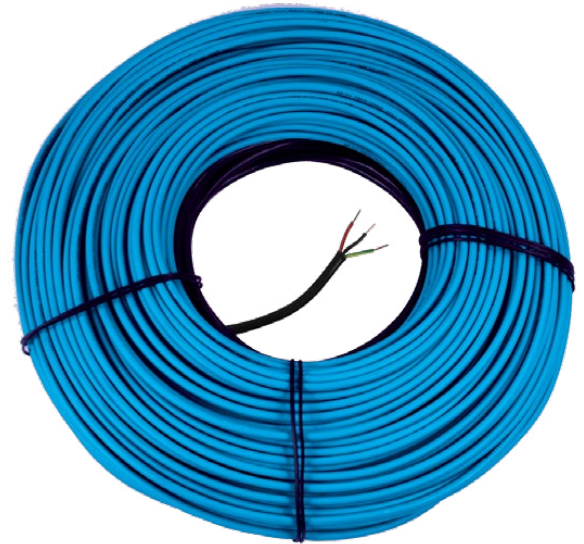

(WSHC-120-00112 shown above)

The amount of cable you'll need depends on the heat output and amount of heating coverage you want, both of which are impacted by the spacing of the heating cable.

The recommended spacing for Slab Heating Cables is 3", which will provide a heat output of over 20-watts per sq. ft.

You can submit a drawing of your project (with dimensions) and we'll provide you with a free installation plan with the exact amount of cable you'll need.

<b>120 Volt INDOOR SLAB HEATING CABLES</b>				
For installation in concrete and in mortar under pavers, tile or stone				
CODE	CABLE LENGTH	WATTS	AMPS	MSRP
WSHC-120-00057	57'	330	2.75	\$225.00
WSHC-120-00082	82'	480	4.00	\$285.00
WSHC-120-00112	112'	660	5.50	\$345.00
WSHC-120-00172	172'	1,020	8.50	\$495.00
WSHC-120-00182	182'	1,080	9.00	\$515.00
WSHC-120-00202	202'	1,200	10.00	\$585.00
WSHC-120-00252	252'	1,500	12.50	\$665.00
WSHC-120-00292	292'	1,740	14.50	\$710.00

<b>240 Volt INDOOR SLAB HEATING CABLES</b>				
For installation in concrete and in mortar under pavers, tile or stone				
CODE	CABLE LENGTH	WATTS	AMPS	MSRP
WSHC-240-00323	323'	1,920	8.00	\$745.00
WSHC-240-00353	353'	2,100	8.75	\$775.00
WSHC-240-00402	402'	2,400	10.00	\$800.00
WSHC-240-00443	443'	2,640	11.00	\$830.00
WSHC-240-00483	483'	2,880	12.00	\$1,035.00
WSHC-240-00523	523'	3,120	13.00	\$1,045.00
WSHC-240-00563	563'	3,360	14.00	\$1,085.00

*Pricing subject to change, because life happens.*

# Floor Heating Controls



UWG4-4999

## nSpire Touch WiFi \$295.00

This programmable model features touchscreen operation, an easy-to-use Install Wizard, and easy access to a detailed log of its energy use. Its WiFi capability also means that a user can operate their heating system remotely. It can even provide the user with weather reports, which could make leaving your house difficult on some winter mornings.

- 3.5" color display
- Built-in GFCI safety
- cULus Class A approved
- Dual voltage: 120 V and 240 V
- Max load: 15 Amps
- Includes in-floor sensor
- 3-year warranty



UDG4-4999-WY (White), UDG4-4999-B (Black)

## nSpire Touch \$229.00

Like the nSpire Touch WiFi, this programmable model also features touchscreen operation, an easy-to-use Install Wizard, and easy access to a detailed log of its energy use. In addition to its modern design, the nSpire Touch provides the user with the ability to easily program their radiant heating system to match their needs.

- Available in White or Black
- 3.5" color display
- Built-in GFCI safety
- cULus Class A approved
- Dual voltage: 120 V and 240 V
- Max load: 15 Amps
- Includes in-floor sensor
- 3-year warranty



# Floor Heating Controls



UDG-4999

## **nHance** **\$189.00**

This programmable model is button-operated and represents a blend of style and usability. By giving the user control over the programming, this model excels at providing optimal comfort with minimal energy consumption.

- Large back-lit display for easy reading
- Built-in GFCI safety
- cULus Class A approved
- Dual voltage: 120 V and 240 V
- Max load: 15 Amps
- Includes in-floor sensor
- 3-year warranty



UTN4-4999

## **nTrust** **\$139.00**

This non-programmable model is button-operated and is perfect for anyone who wants a thermostat that is both easy to install and easy to look at. It's sleek, minimalist appearance blends well with almost any design theme and operating it couldn't be simpler.

- Large back-lit display for easy reading
- Built-in GFCI safety
- cULus Class A approved
- Dual voltage: 120 V and 240 V
- Max load: 15 Amps
- Includes in-floor sensor
- 3-year warranty



## **nJoin Power Module \$130.00**

The nJoin Power Module links up to any WarmlyYours thermostat in the nSpiration series to increase electrical output to allow for heating large applications. Simply put, if you need to heat a larger area with one master thermostat, the nJoin power module can help.

# Floor Heating Underlayment

---

A crucial part of planning a floor heating project that is often overlooked is the selection of a proper underlayment. While not every project requires underlayment, they are particularly useful for projects where there is concern about heat loss to the subfloor (such as when the subfloor is a concrete slab or when it's over an uninsulated room in non-heated space like a garage) or when subfloor issues threaten to compromise the integrity of relatively fragile flooring types like tile, marble, or stone.

WarmlyYours offers 3 different underlayment products:

- Prodeso Cable Installation Membrane
- Cork
- CeraZorb®

The Prodeso Cable Installation Membrane is an uncoupling membrane that can only be used with the TempZone Floor Heating Cable. The membrane provides long lasting uncoupling and crack isolation benefits for tile, marble, and stone floors. The benefit of uncoupling is that it allows for a small degree of foundational movement (which occurs when a house “settles”) without causing the tiles in the floor to crack, break or “pop.” The idea behind crack isolation is that it stops cracks (up to a certain size) in the subfloor from “telegraphing” upwards into the floor which can cause extensive damage. An additional benefit of the membrane is that it can greatly decrease installation time as it allows an installer to complete most residential installations in a single day.

Cork and CeraZorb® are both “insulating” underlayments. Cork is a natural material that is a little thicker than CeraZorb® and is often paired with our Environ floor heating systems. CeraZorb® is a synthetic underlayment that has a higher degree of thermal resistance (R-value of 1.5) than cork. CeraZorb® is also the recommended underlayment for heating on top of a concrete slab and is often paired with our TempZone floor heating products. Both insulating underlayments will also provide some degree of crack isolation benefits.

To find out more about which underlayment option you should choose for your heated floor, contact WarmlyYours today.

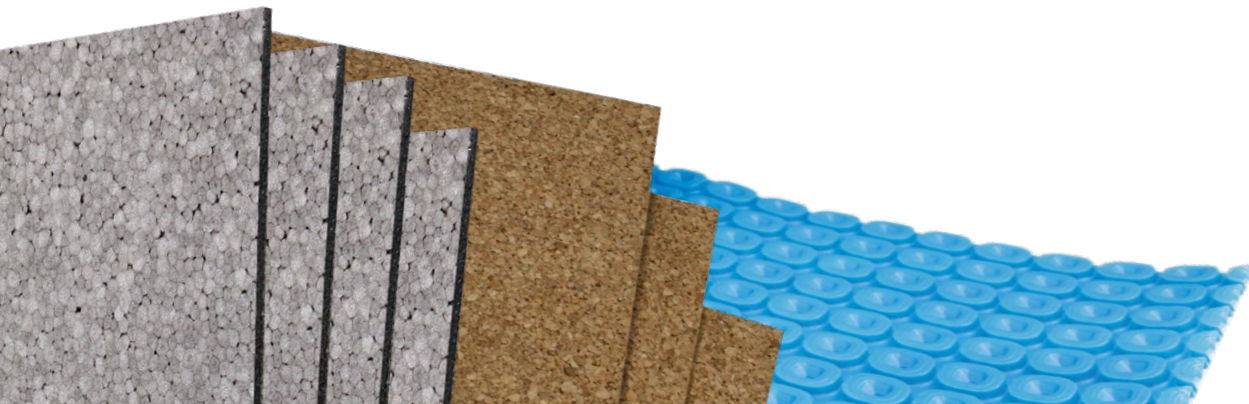

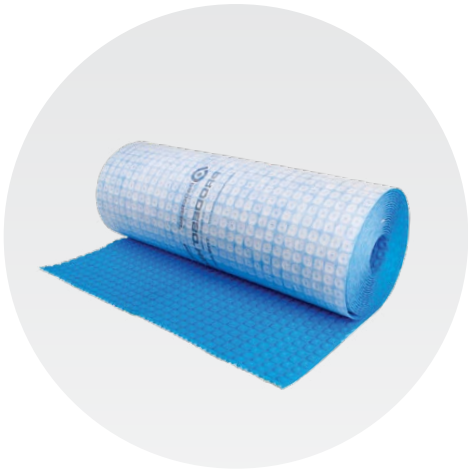

## Prodeso Cable Installation Membrane

- Installed directly over the entire subfloor as an uncoupling, crack isolating membrane
- Limited 10-year Warranty.

SIZE	SQ. FT.	MSRP
3.3 ft. x 2.4 ft.	7.9	\$39.00
3.3 ft. x 16.4 ft.	54.0	\$169.00
3.3 ft x 49.2 ft.	161.5	\$419.00



## CeraZorb® Synthetic Cork Underlayment

- Recommended when installing your TempZone™ floor heating system over a concrete slab.
- Can be set under tile and stone, over any acceptable sub floor.
- Up to 25 times lighter than 1/4" backer board.
- Lightweight, only 28 lbs. per 400 sq. ft. box.
- Heat and cold resistant, and will not rot, support mold and mildew, or absorb moisture.
- Stable and durable, remaining unchanged after repeated impact loads.
- Limited 5-year Warranty.

SIZE	SQ. FT.	MSRP
2' x 2' (Pack of 12)	48 sq. ft	\$199.00
4' x 4' (Pack of 25)	400 sq. ft.	\$800.00



## Cork Underlayment

- Recommended when installing your Environ™ Easy Mats floor heating system over a concrete slab.
- Cork underlayment installed on slab creates a thermal break and increases the energy efficiency of the system.
- Limited 10-year Warranty.

SIZE	SQ. FT.	MSRP
2' x 3' (Pack of 4)	24 sq. ft.	\$60.00

# Accessories

## Electrical Rough-In Kits

Whether you're a homeowner or trade professional, it's vital to have the right tools for your radiant heating project. To provide this peace of mind, WarmlyYours has developed our Electrical Rough-In Kits that cover any local electrical code. These kits include everything you need to safely and correctly install a thermostat.

Our kits are available with either single-gang or double-gang boxes.



### Electrical Rough-in Kit with 2 Conduits \$49.99

This is a great option for areas where the local code requires a separate conduit for low-voltage wires. With everything an electrician will need to install and connect a thermostat in accordance with this type of electrical code, this kit has you covered.

#### Included Items

- 3" X 2" X 3 1/2" Single-Gang Box
- (25) 3/16" or 5mm low-volt staples
- 5" Cable Protector
- (2) 1/2" x 6' Flexible Metal Conduit
- (4) 1/2" Flexible Metal Conduit Anti-short Bushing
- (2) 1/2" Set Screw Connector
- (2) 1/2" EMT Drive Strap
- 3/8" x 4" Black Flex Tube

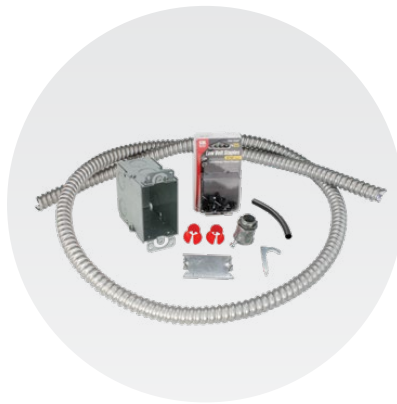

### Electrical Rough-in Kit with Conduit \$39.99

Getting the job done correctly has never been easier with this complete electrical kit. It contains everything an electrician needs to install and connect a thermostat with an electric radiant heating system in accordance with National Electric Code.

#### Included Items

- 3" X 2" X 3 1/2" Single-Gang Box
- (25) 3/16" or 5mm low-volt staples
- 5" Cable Protector
- 1/2" x 6' Flexible Metal Conduit
- 1/2" Flexible Metal Conduit Anti-short Bushing
- 1/2" Set Screw Connector
- 1/2" EMT Drive Strap
- 3/8" x 4" Black Flex Tube



### Electrical Rough-in Kit without Conduit \$29.99

This kit was developed for projects in which the local electrical code does not require conduit for the low-voltage sensor wire or the power leads. It includes everything an electrician will need for installing and connecting a thermostat.

#### Included Items

- 3" x 2" x 3 1/2" Single-Gang Box
- (25) 3/16" or 5mm low-volt staples
- 5" Cable Protector
- 3/8" x 4" Black Flex Tube

# Installation Kits

## TempZone™ Floor Heating



### Basic Installation Kit

**\$35.00**

This kit was designed for experienced trade professionals and DIYers who are conducting small, one-step electric floor heating installations.

#### Included Items

- Margin Trowel
- 3/8-inch Notched Trowel



### Silver Installation Kit

**\$85.00**

This kit was developed for larger one-step electric floor heating installations. A step up from our Basic Installation Kit, this package includes an Epoxy Grout Float.

#### Included Items

- Margin Trowel
- 3/8-inch Notched Trowel
- Kneeler Board
- Epoxy Grout Float



### Gold Installation Kit

**\$105.00**

This kit is recommended for two-step installations that do not require underlayment. This package includes a finishing trowel and a dense rubber float.

#### Included Items

- Margin Trowel
- 3/8-inch Notched Trowel
- Kneeler Board
- Epoxy Grout Float
- Dense Rubber Float
- Finishing Trowel



### Platinum Installation Kit

**\$125.00**

The Platinum Installation Kit offers all the accessories needed to install a WarmlyYours TempZone™ floor-heating system – from underlayment to finish.

#### Included Items

- Margin Trowel
- 3/8-inch Notched Trowel
- Kneeler Board
- Epoxy Grout Float
- Dense Rubber Float
- Finishing Trowel
- 1/8-inch V-Notch Trowel

# Merchandising Materials

WarmlyYours offers merchandising materials for our radiant heating products. We've featured some of our most popular items in this section. See our entire line of merchandising materials online at [www.WarmlyYours.com](http://www.WarmlyYours.com).



## Showroom In-floor Display Package

- The first 15 Sq. Ft. of floor heating of your choice is FREE (any additional square footage is available at 50% off)
- For under tile or stone flooring, choose from TempZone™ Flex Rolls, Easy Mats, Cables
- For under carpet, laminate, or floating wood flooring, choose from Environ\* Flex Rolls or Easy Mats
- Includes a programmable thermostat and Circuit Check
- Includes CeraZorb® or Cork underlayment

*\*Not for use under carpet in Canada. US only.*



## Heated Tabletop Display

12" (305 mm) W x 16" (406 mm) H x 10 1/2" (267 mm) D heated tabletop display plugs into 120V outlet, with two take-one cups.



### Take-One Brochure

8" x 4" tri-fold take-one brochures



### Sample Cards

Product sample cards with dealer imprint area on back. (4.5" x 4.5")



### Underlayment Sample

Our CeraZorb® and Cork Insulation Boards increase energy efficiency and will not rot, absorb moisture, or support mold or mildew.

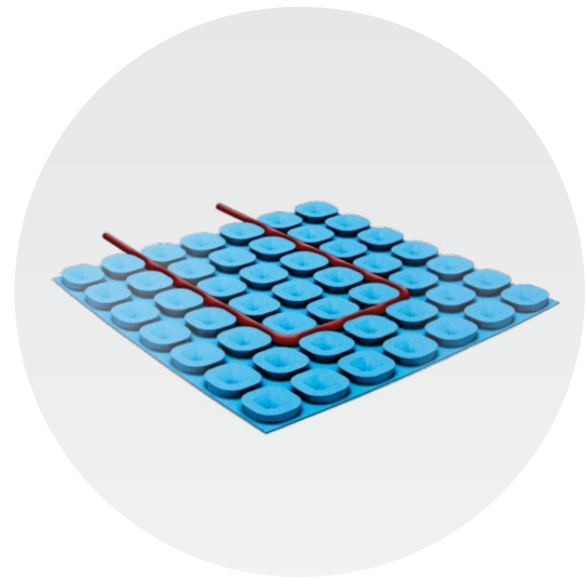

### TempZone™ Cable & Prodeso Sample

Product sample (5" x 6", 1 sample)



**Be Connected.  
Be Warm. Be Radiant.**

**WarmlyYours HQ** 

590 Telser Road,  
Lake Zurich, IL 60047

**WarmlyYours** 

300 Granton Drive, Unit 4A  
Richmond Hill, ON L4B1H7

**800-875-5285**

[www.WarmlyYours.com](http://www.WarmlyYours.com)

**Connect with Us**



Industry leading 24/7 installation and technical support.  
Our experts can answer any technical questions on any  
product we offer, 24/7.



*Scan here to learn  
more about Electric  
Floor Heating.*

**Ask us about our Snow Melting  
and Comfort Collection Catalog.**