

Installation Instructions



QEK-NO1

Email: support_service@hacubu.com

Parts List

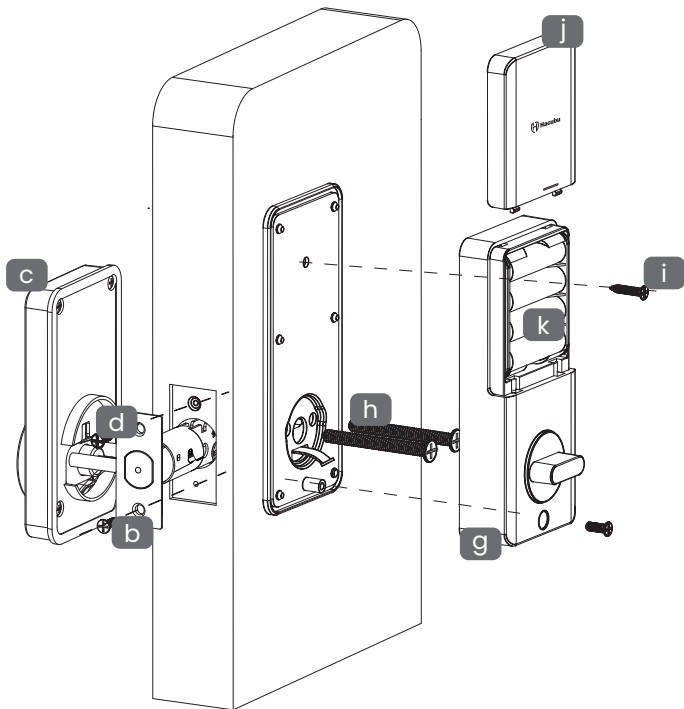

The details of part identification is shown on following page

Product layout

Back Panel

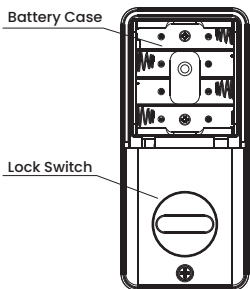
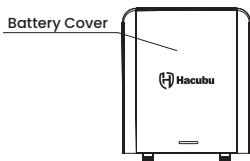

Front Panel

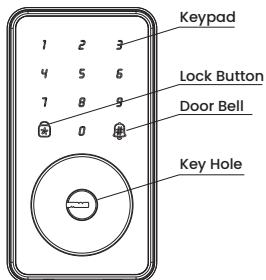

Reset

(Press the reset button 6 seconds, follow the voice signal, reset the lockset succeeded)

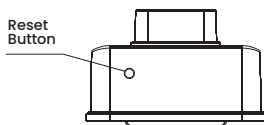

The bottom of front panel

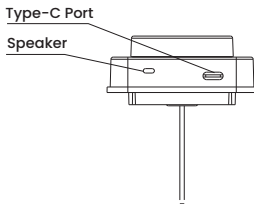

Parts identification

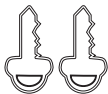

a

key*2

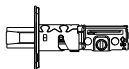

b

Lock Body



c

Front Panel



d

Lock Body
Mounting Screws*4

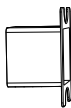

e

Buckle Box



f

Strike Plate



g

Back Panel



h

M6x50 Screws*2



i

ST4*20



j

Battery box cover



k

4*Battery

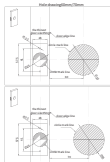

l

Hole Drawing Paper



m

User Manual*1

Place the hole drawing papere on the door

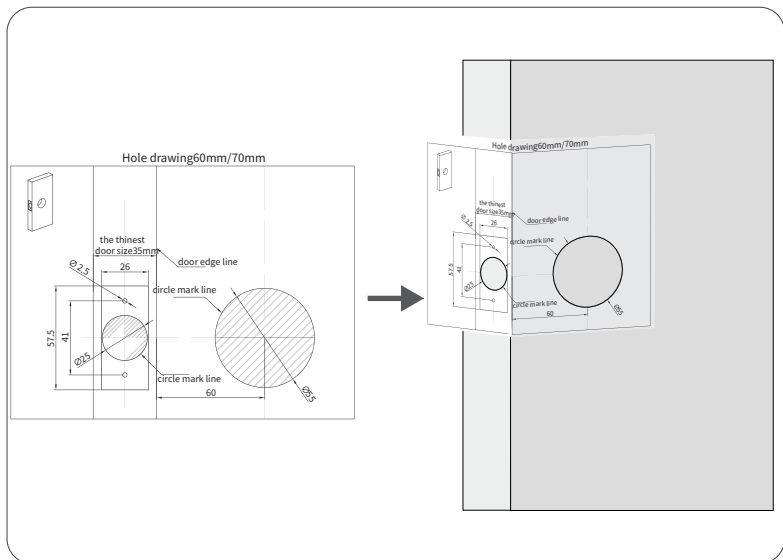

Open the hole for lockset

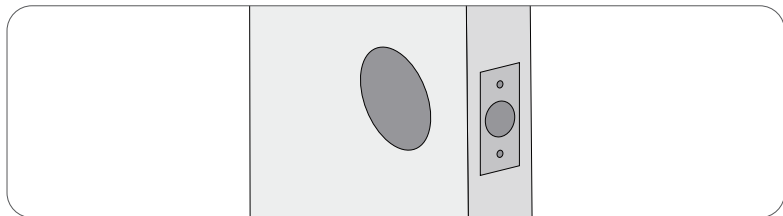



Before Installing the Lock, Check Door Jamb and Door Preparation

Door thickness:
1-3/8" to 2-11/64"
(35mm to 55mm)

Lockset Front
door hole
2-11/64" (55mm)

Backset thickness:
2-23/64" or 2-3/4"
(60mm or 70mm)

lock body hole:
63/64" (25mm)

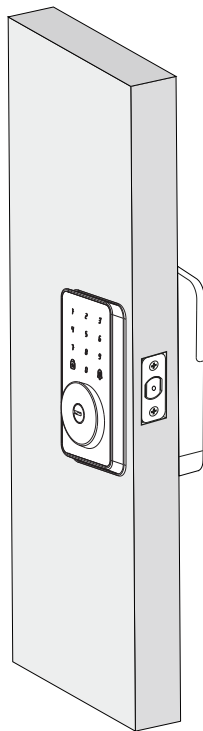

1.Prepare the door and check dimensions

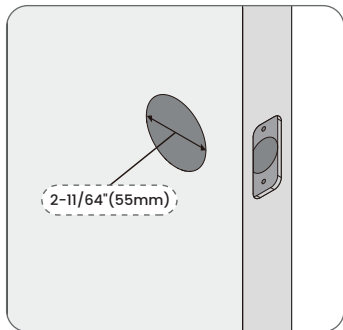

Measure to confirm that the hole in the door is $2-11/64"$ (55mm)

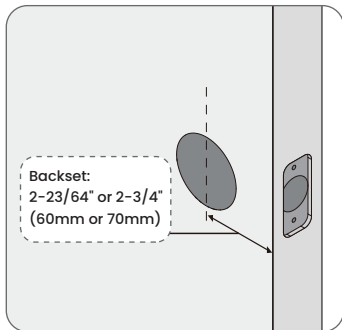

Measure to confirm that the backset is either

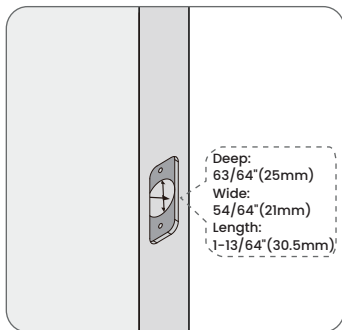

Measure to confirm that the hole in the door is $63/64"$ (25mm)

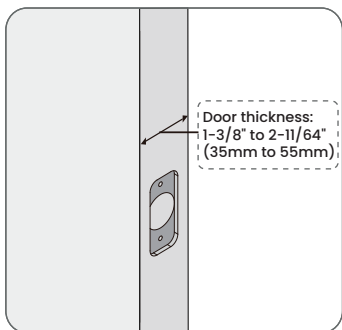

Measure to confirm that door thickness is between $1-3/8"$ to $2-11/64"$ (35mm to 55mm)

2. open the strike hole, deep 25 mm , and install it with screw

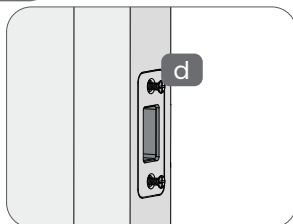
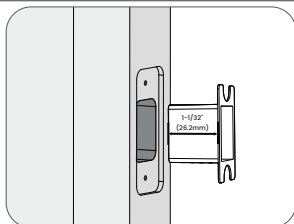

3. Install the Lock Body

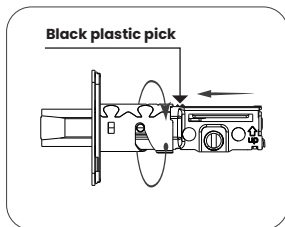
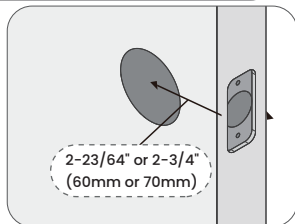

The lock body can rotate to lengths of 2-23/64" or 2-3/4" (60mm or 70mm). Please choose according to the length of the door panel opening

Open the black plastic pick of the lock cylinder to pop out the lock tongue, and rotate the lock cylinder to adjust the size.

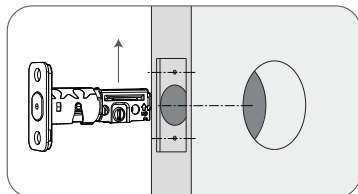

Make sure the UP side is facing up and the bolt is closed before installing it into the door opening.

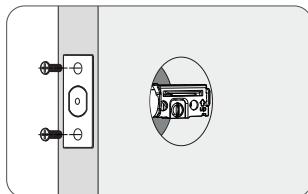

Install the lock body into the door panel
Use Lock Body Mounting Screws*2

4. Install the Front Panel (Standing Outside)

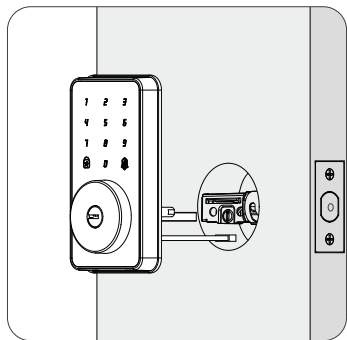

Thread the cable under the lock body

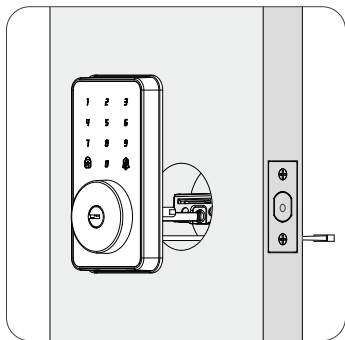

Keep the locking bar vertical when installing

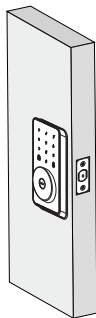
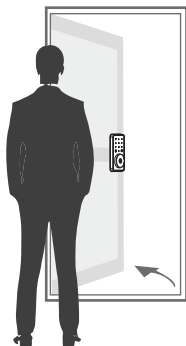

Keep the locking bar vertical when installing

5. Install the Back mounting plate

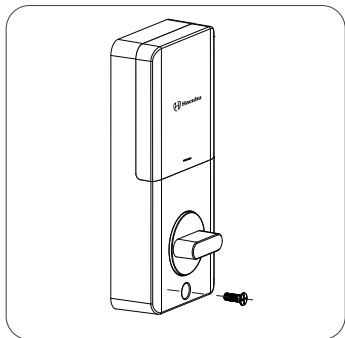

unscrew the back panel screw,
Remove the mounting plate

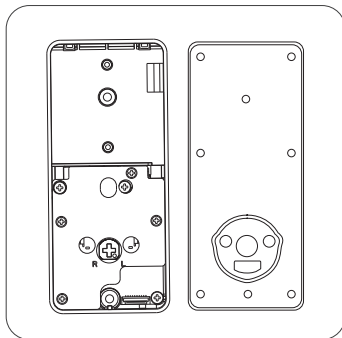

Remove the mounting plate

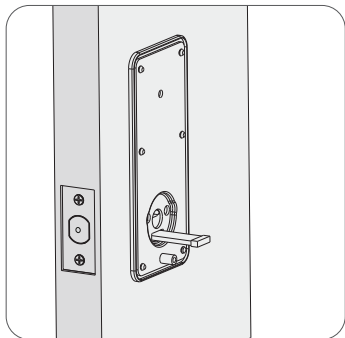

place the cable like
this in the mounting plate

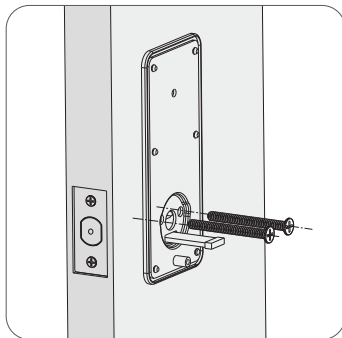

Secure the mounting
plate with the supplied screws

6. According to your actual door open direction to adjust the knob dot direction

Left opening Way door



The Back panel knob adjusted to horizontal

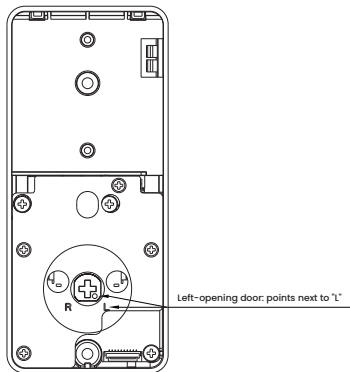
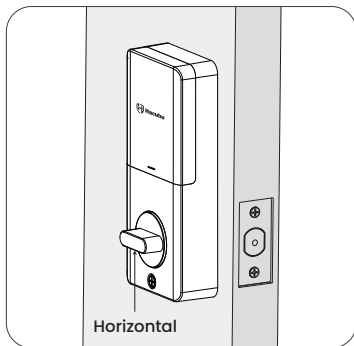

6. According to your actual door open direction to adjust the knob dot direction

Right opening Way door



The Back panel knob adjusted to Vertical

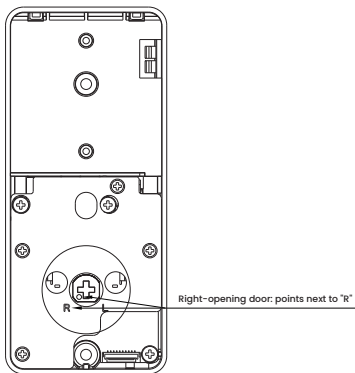
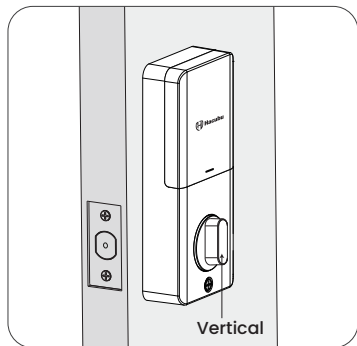

7. Install the Back Panel

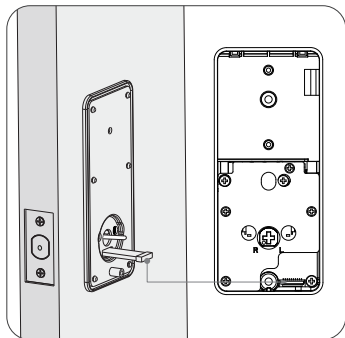

Connect the main cable

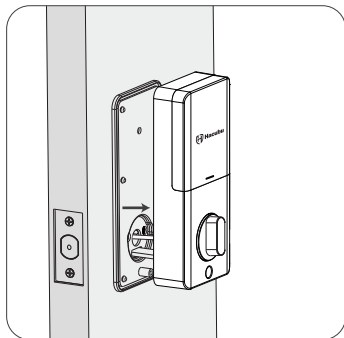

Insert the Back panel with direction of correspondence

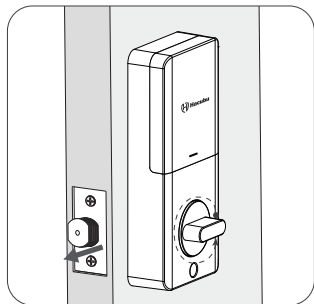

Test: Can the switch rotate to open the door?
If can't, the direction of the knob is incorrect, return to step last step to adjust the direction

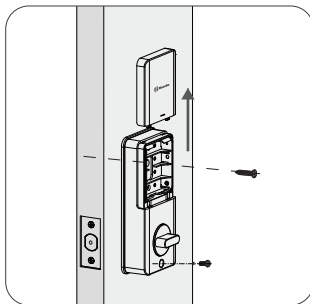

Install the screws



8. Install the battery

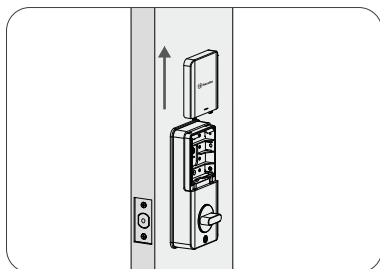

Push upwards to open the battery cover

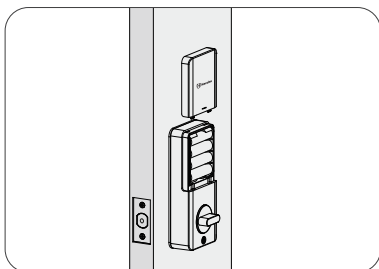

Install 4 batteries in the battery compartment

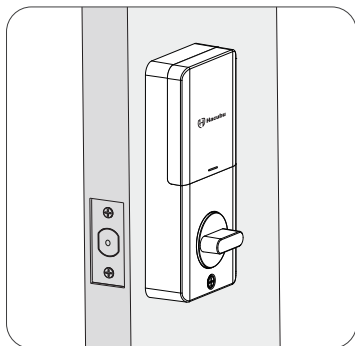

install the battery cover

9. Detect left/right hand door installation

! IMPORTANT: This step is required and crucial for the lock after installation!

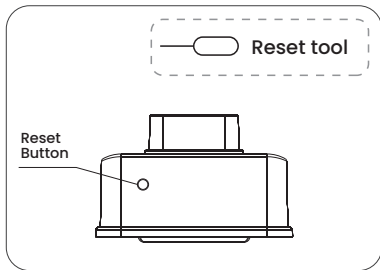
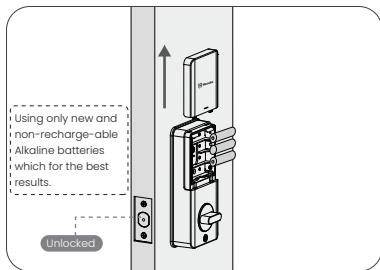

While the door is open and unlock, load 3AA batteries into the interior assembly.

Press and hold the reset button on the interior assembly using the reset tool.

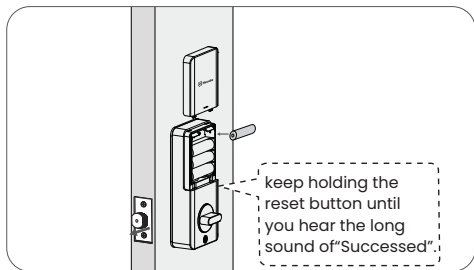

Keep holding the reset button, and load the last battery. Hold the reset button until you hear the long sound of "Succeeded". The lock will automatically go into locking position. this is for the smart lock to memorize the orientation of the door



Programming Instructions

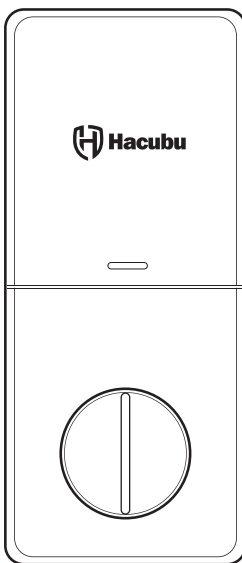
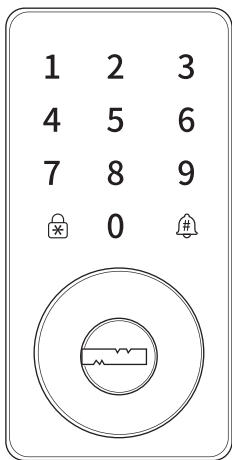

QEK-NO1

Email: support_service@hacubu.com

Function

1. Anti-Peeping Code
2. One Touch Lock & Auto Lock
3. Backlit Digital Keypad
4. Doorring
5. Wrong Entry Limit
6. Pin Code Unlock
7. Key Unlock

Reset

Press the reset button 6 seconds, follow the voice signal, reset the lockset succeeded

Reset
Button

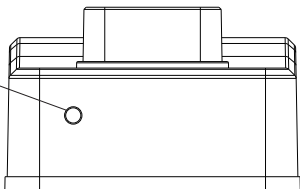

How To Use?

Unlock the door from outside

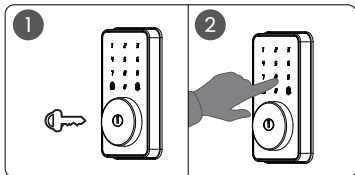

Unlock the door from outside

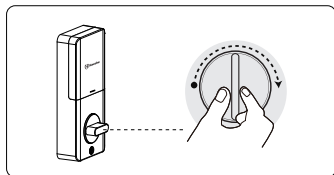

Anti- Peeking Password

Random numbers (up to 12 digits) can be added before and after the correct password to ensure security and prevent peeping.

Real Password

Random Digits

36479528

Random Digits

1. master PIN code (8 digits): None default master pin code, it's required that you set it before programming.
2. user pin code (8 digits): a total of 100 pin code (includ 9 master pin code) may be programmed.
3. both master and user pin codes don't support the following combination of numbers below.

- A.

1	2	3	4	5	6	7	8
---	---	---	---	---	---	---	---

 ❌ forward number sequence
- B.

9	8	7	6	5	4	3	2
---	---	---	---	---	---	---	---

 ❌ backward number sequence
- C.

2	2	2	2	2	2	2	2
---	---	---	---	---	---	---	---

 ❌ repeat number sequence

Lock the door from outside

Auto lock mode

In auto lock mode, the bolt will extend out automatically in 6 seconds after unlocking.

One Touch Lock

Press * buttons on keypad for 2 seconds.

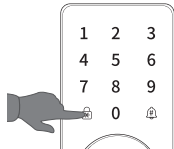

Lock the door from inside

Auto re-lock mode

In auto lock mode, the bolt will extend out automatically in 6 seconds after unlocking.

Manual mode

Rotate the turn piece to lock position.

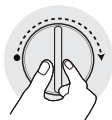

Factory Default Setting

Setting	Factory Setting
code	random 8 digits
auto lock	6s
wrong code entry limit	5times
unlock mode	ONE WAY UNLOCK MODE



Reset if you wanna restore factory default settings

This procedure will delete all user codes which associated with the lock

Definitions

1 Master Code

Required for programming and feature settings. Property owner/manager should keep this information confidential.

2 Auto Lock

Automatically locks the deadbolt 6 seconds after unlocking. This feature off by default. You can set the Auto Lock time delay between 0-180 seconds.

3 Wrong Entry Limit

After 5 unsuccessful attempts at entering a invalid PIN code, the unit will shut down for 90 seconds.

4 Unlock Mode

Single unlock:

A set of passwords to unlock the door.

Combination unlock:

Two sets of passwords to unlock the door

Quick Set Up

- The default code is random 8 digits. it's required that you set one master code before programming.
- When setting is unsuccessful, the lock voice guid will say failed.
- Query code number: input the code to unlock the lock and then press the * key to broadcast the code number.

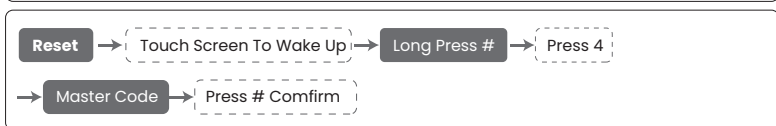
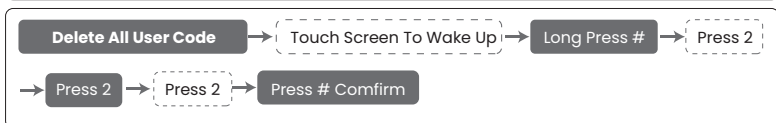
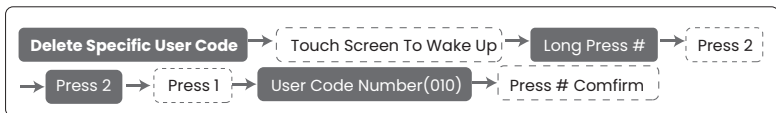
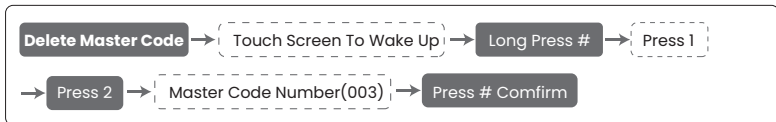

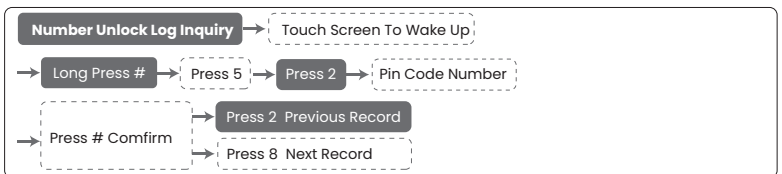
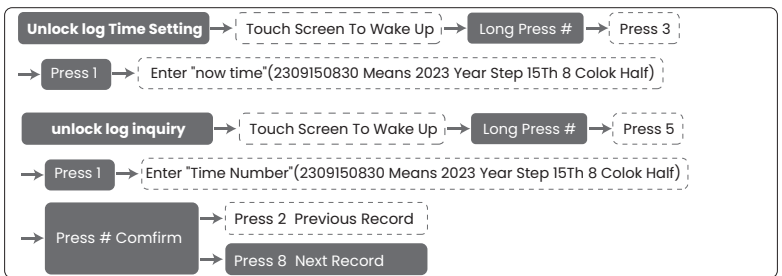
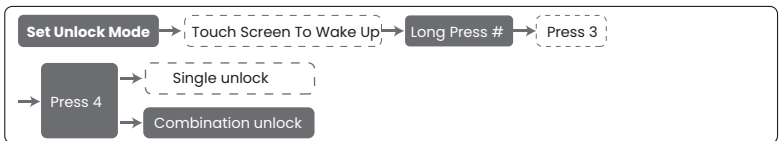
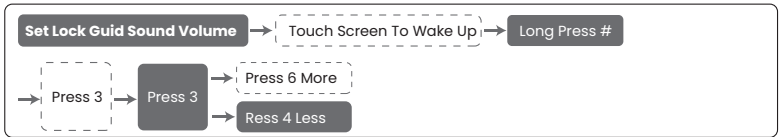
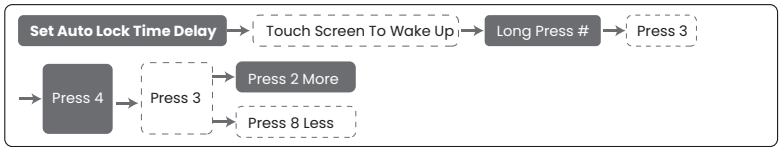

Troubleshooting

1 Installation

Questions	Answers
The latch does not operate correctly after installation.	<ul style="list-style-type: none"><input type="checkbox"/> Make sure the backset on the latch is set to the proper length. Refer to Installation Instructions<input type="checkbox"/> Make sure prior to installation latch bolt is retracted and key is not in lockset when installing the deadbolt. Refer to installation instructions<input type="checkbox"/> Make sure Locking Bar Keep Vertical When Installing and Adjust Your Door Opening Direction,Knob Button Is Horizontal For Left Opening Door;Knob Button Is Vertical For Right Opening Door when installing back panel<input type="checkbox"/> Please restore to factory setting and set one master code before programming.Refer to Programming Instructions
Feel a bump while turning the thumb turn or the key?	<ul style="list-style-type: none"><input type="checkbox"/> Check if the length of mounting screws is correct.<input type="checkbox"/> Check if the turn piece is in vertical (unlock) position.

Questions	Answers
Fail to set up the lock.	<ul style="list-style-type: none"> <input type="checkbox"/> Please make sure the lock is installed correctly. <input type="checkbox"/> Please install fresh batteries and make sure the cable is connected correctly. <input type="checkbox"/> After installation, reset the lock to complete the bolt direction setting.
Lockset is not able to unlock / lock by keypad.	<ul style="list-style-type: none"> <input type="checkbox"/> Make sure you have entered the correct User Code. <input type="checkbox"/> The battery is low if the battery indicator light keeps flashing. Please replace with four new batteries. <input type="checkbox"/> Make sure the cable is firmly onnected. Check the cable for any damage that may have occurred during installation. Make sure the batteries are properly installed. (Alkaline batteries only.) <input type="checkbox"/> Check the strike plate to make sure it is properly aligned and clear so the bolt can freely move in the hole.
Lockset is unable to reset.	<ul style="list-style-type: none"> <input type="checkbox"/> Please refer to Programming instructions to restore factory settings and reprogram all codes. <input type="checkbox"/> The battery is low if the battery indicator light keeps flashing. Please replace with four new batteries.

Questions	Answers
How to operate the lockset in darkness?	<input type="checkbox"/> Press any button to activate the lockset back light.
The lockset locks when I enter my code and unlocks when I press the #	<input type="checkbox"/> Un-install the interior and exterior assemblies. Before re-installation, please follow these guidelines: Refer to Installation Instructions 1) Make sure the bolt is in the retracted position. 2) Do not have any key in the cylinder during installation. 3) Make sure the turn piece is inserted horizontally. <input type="checkbox"/> Reset the unit to factory settings and reprogram the Master Code and User Codes.
I cannot remove my key unless it is in the locked position.	<input type="checkbox"/> Un-install the interior and exterior assemblies. Before re-installation, please follow these guidelines: Refer to Installation instructions 1) Make sure the bolt is in the retracted position. 2) Do not have any key in lock cylinder. 3) Make sure the turn piece is inserted horizontally.



If the lock appears to be damaged or does not operate properly, please contact customer service for further assistance.



QEK-NO1

Email: support_service@hacubu.com