

Brand Concept

Mansader, a top manufacturer and good designer, has decades of experience in manufacturing patio products. Each piece is sleekly designed, rigorously tested for durability, and assembly instructions have been standardized for simplicity from start to finish.

Mansader always looks forward to creating a freedom lifestyle for more people, and more opportunities to explore the unknown and explore the value of life!

Mansader hopes your leisure time delightful and comfortable by providing more patio products with reliable craftsmanship and durable material and 24 Hours service.

Our Service

30-day money back guarantee.

90-day warranty for quality-related issue with free replacement.

24 Hours Online Customer Service FOR YOU!

Reminder: Be sure to use your product as directed.

WhatsApp: 0086-13905747420

EMAIL: mansader@163.com



Order Status



Installation Help



Gift Cards



New Product Discount

Part & Accessories

NO	HARDWARE LIST	QTY
A	 Tent	1PC
B	 Rope	8PCS
C	 Steel Peg	16PCS
D	 Bag	1PC
E	 Out Tent	1PC
F	 Long Frame Tube	2PCS
G	 Short Frame Tube	1PC

Care & Maintenance

1. Keep all flame and heat sources away from this tent fabric. This tent is made with fabric that meets CPAI-84 specifications for flame resistance. It is not fire proof. The fabric will burn with continuous contact with any flame source.
2. Don't place any other material on the face side of tent.
3. This is a temporary sun shelter. It should not be used while there is heavy rain or strong or sustained wind.

Precautions

1. Check all parts and hardware listed on the parts list. Lay them on a clear and level surface prior to assembly.
2. It is recommended to have 2 people for assembly.

SET UP

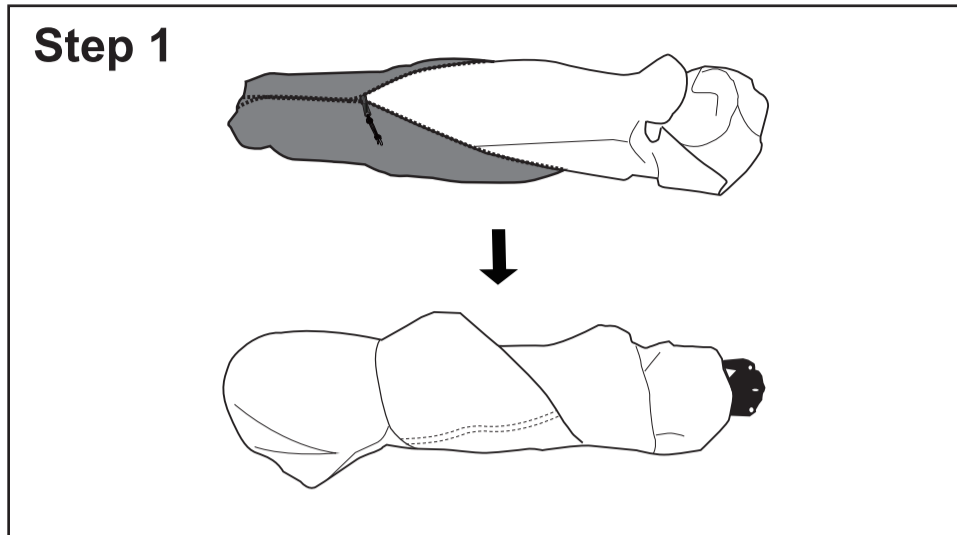

Take the tent out of the bag

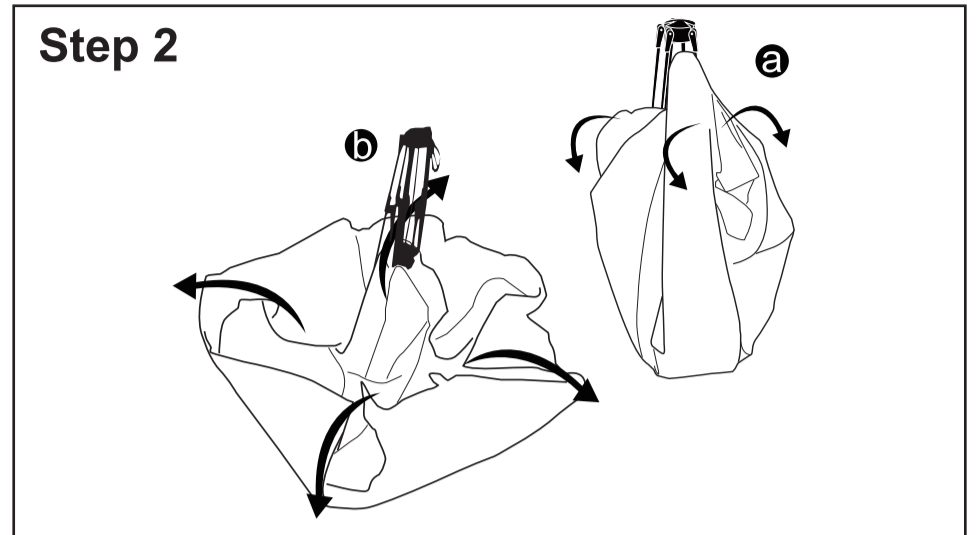

Spread out the four corners of the tent

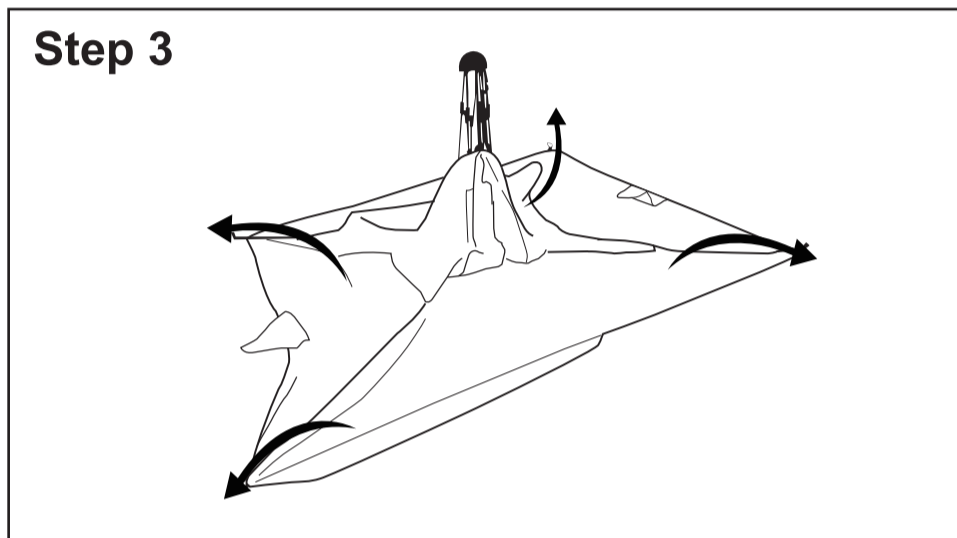

Spread on the ground

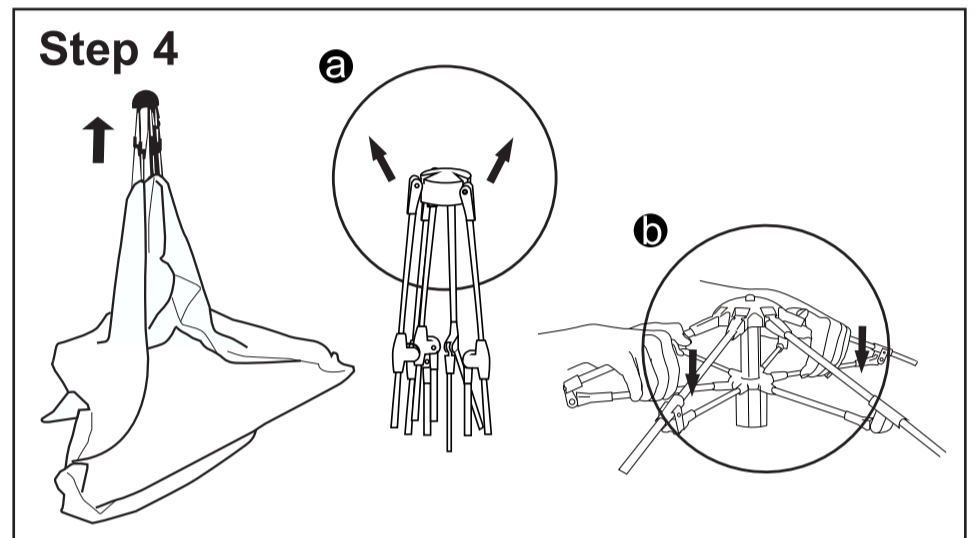

Hold the top of the tent and lift it up, and then press the top down to make sure that the tent is fully buckled 3

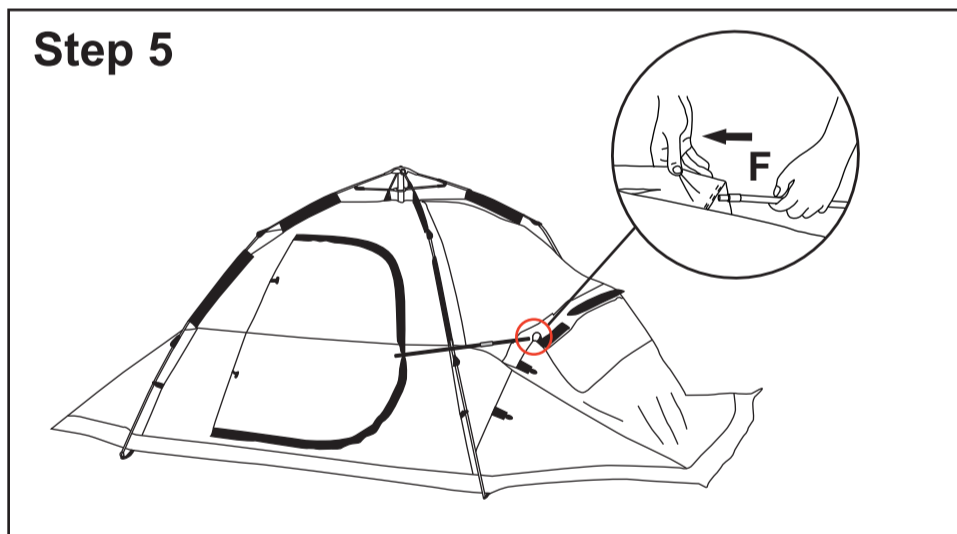

Insert side poles to the pole sleeve on both sides

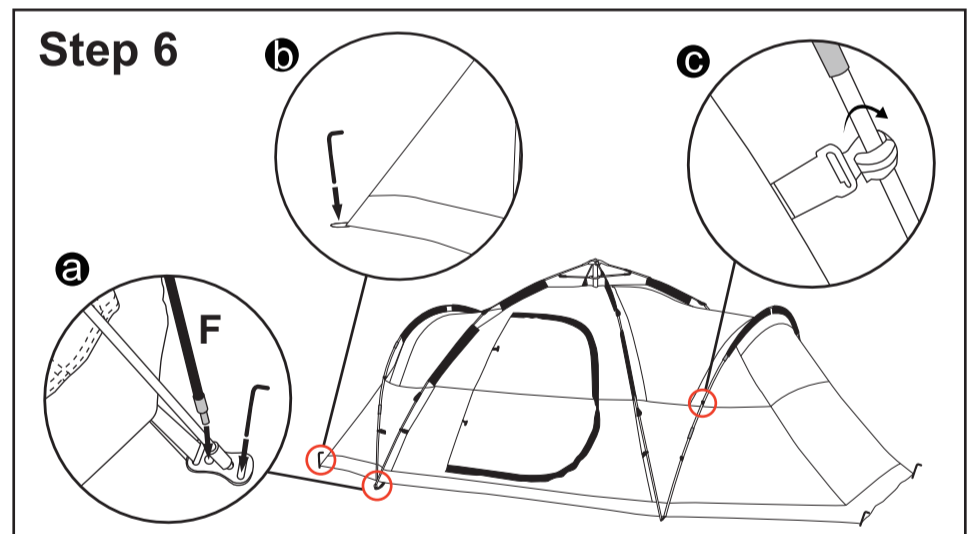

Stake out tent corners, clip plastic tentclips to the fiberglass poles

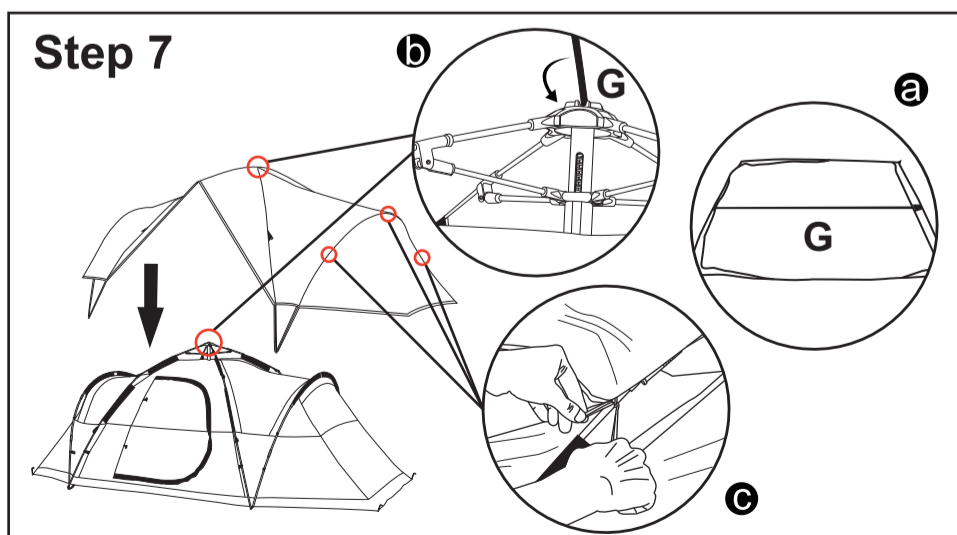

Attach the rainfly to the tent and insert the vestibule pole

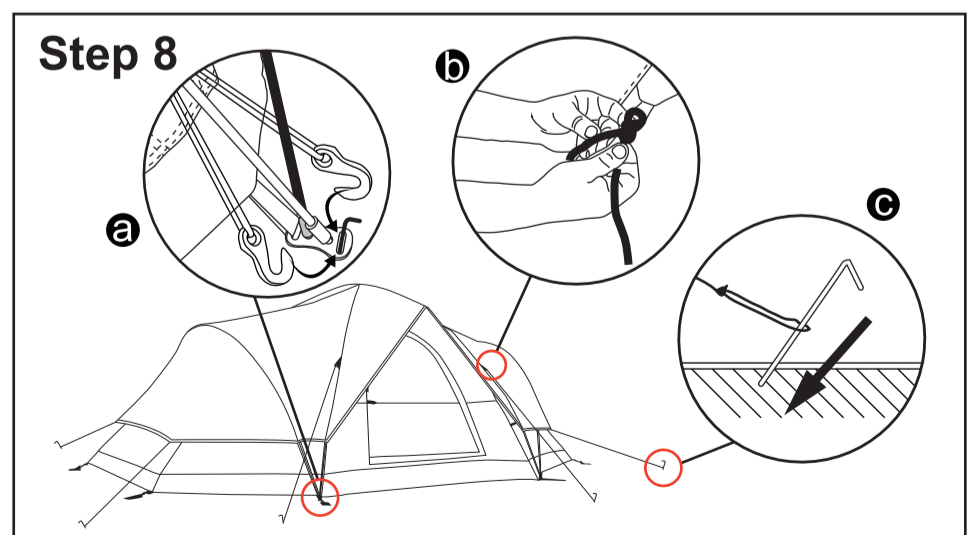

Attach guy lines and adjust sliders

TAKE DOWN

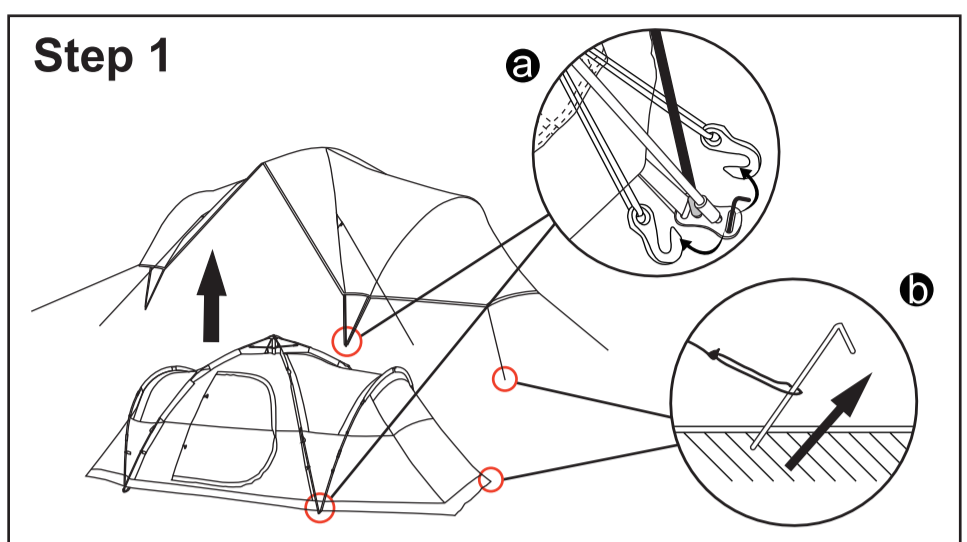

Remove the rainfly, all stakes and guy line

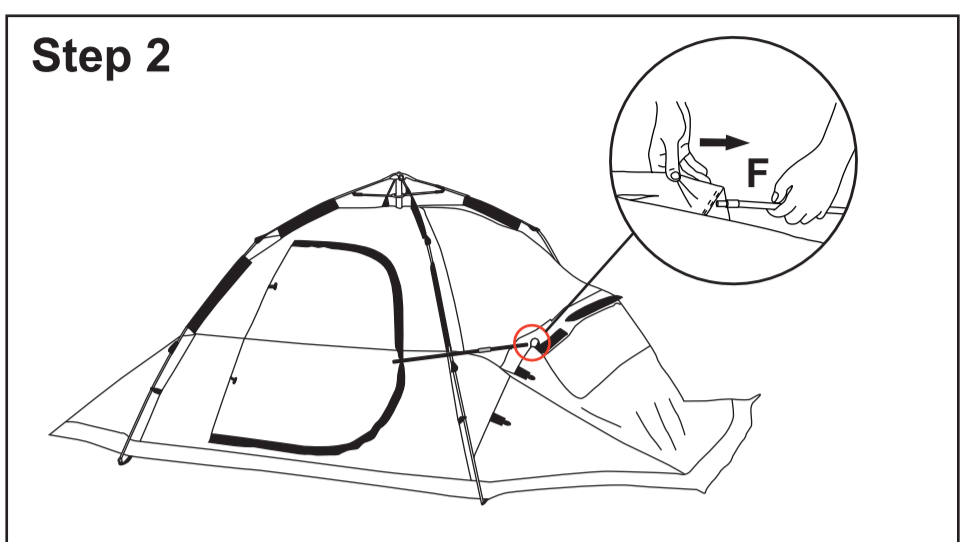

Remove the side poles

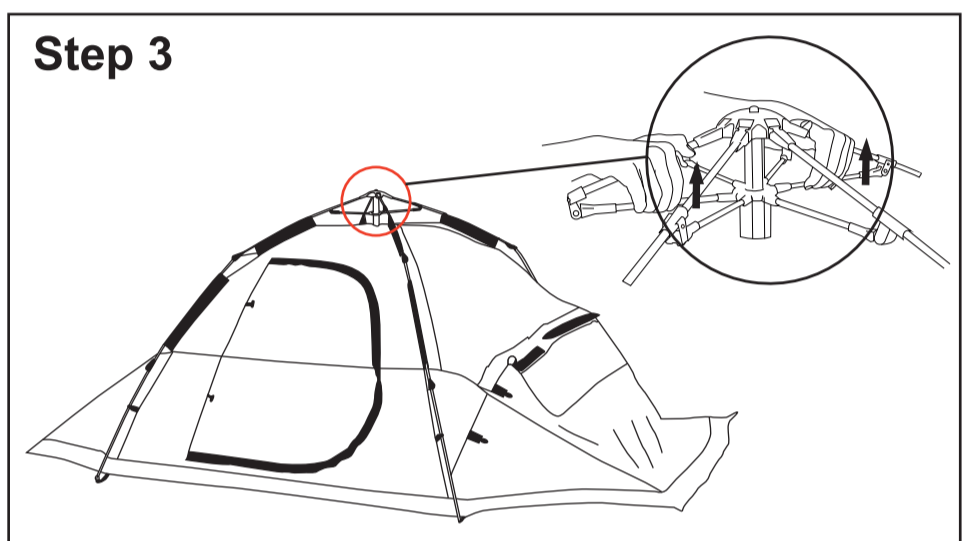

Hold the top two side rods and lift up

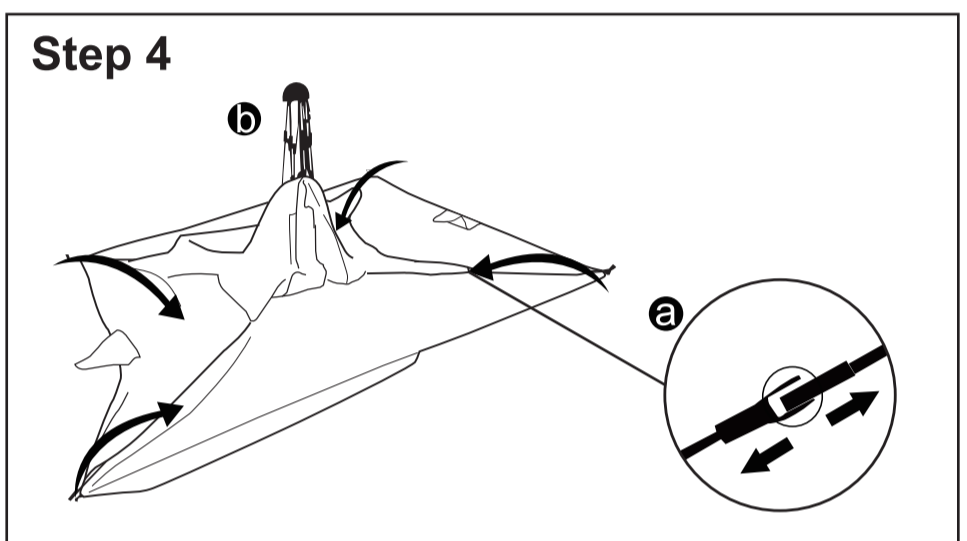

Pull down to unlock the joint

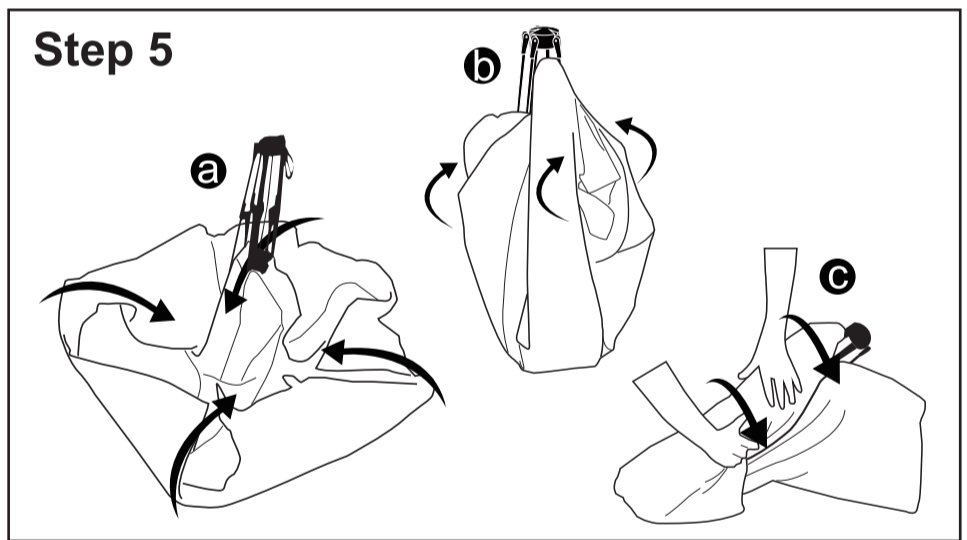

Fold the tent

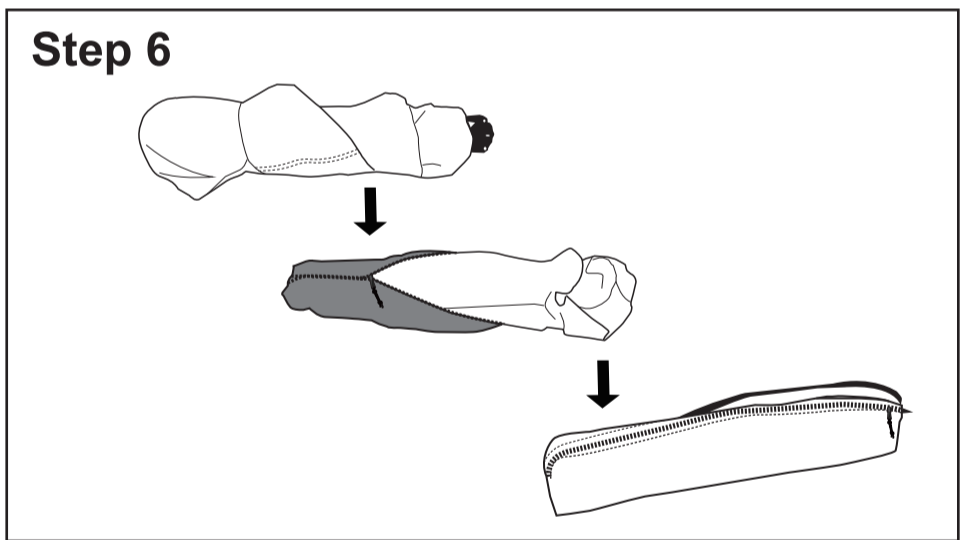

Put the tent in the storage bag

5

6