	<p>40'</p>
		
		<p>2</p>

G

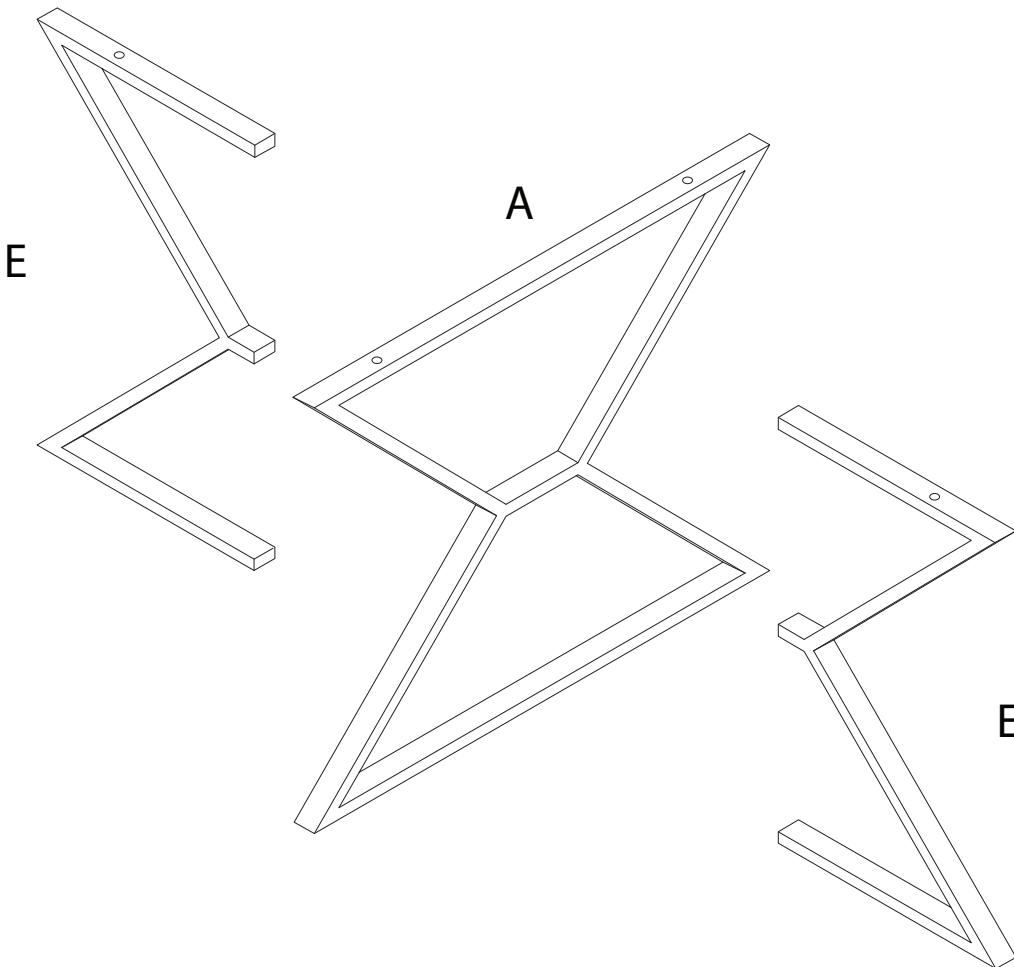

A

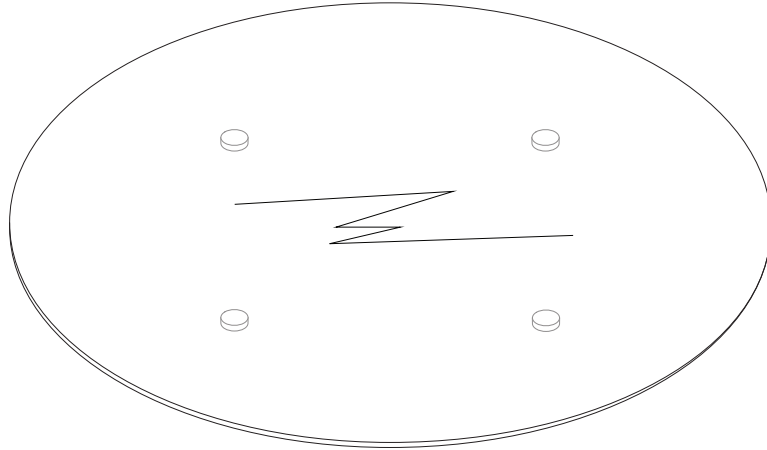
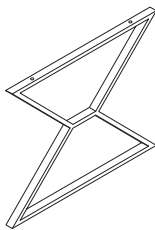

x 1

B

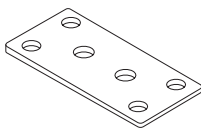

x 3

C

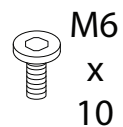

M6
x
10

x 18

D

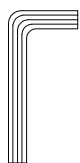

x 1

E

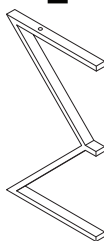

x 2

F

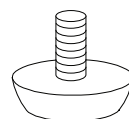

x 4

G

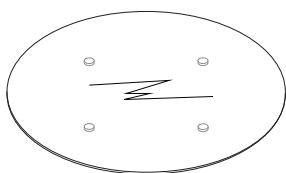

x 1

H

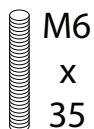

M6
x
35

x 4

I

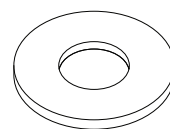

x 4

J

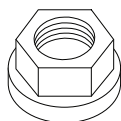

x 4

K

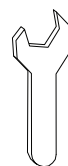

x 1

1

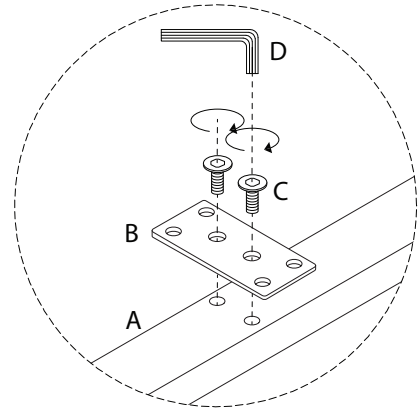
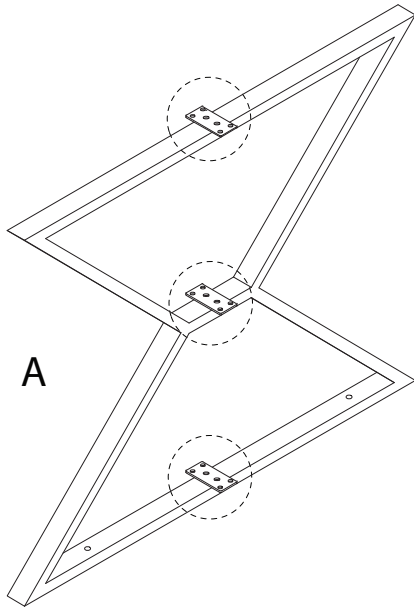
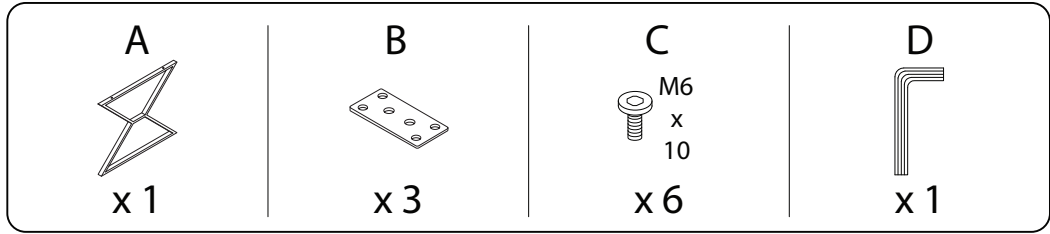

2

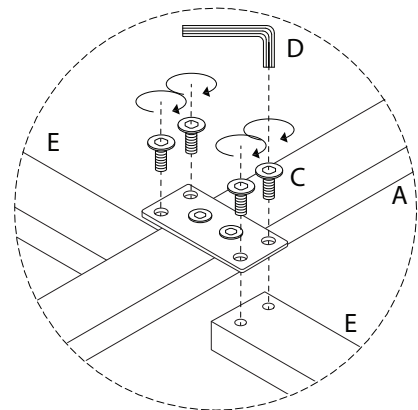
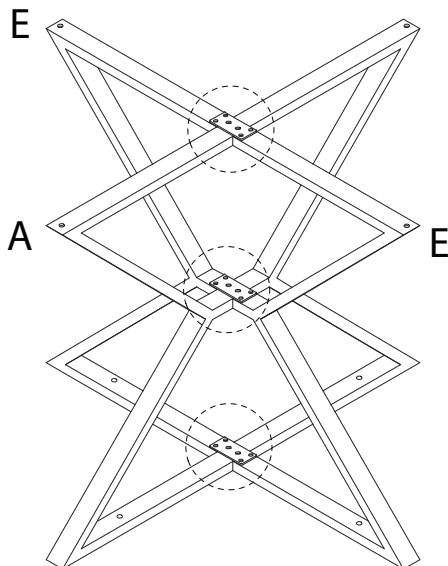
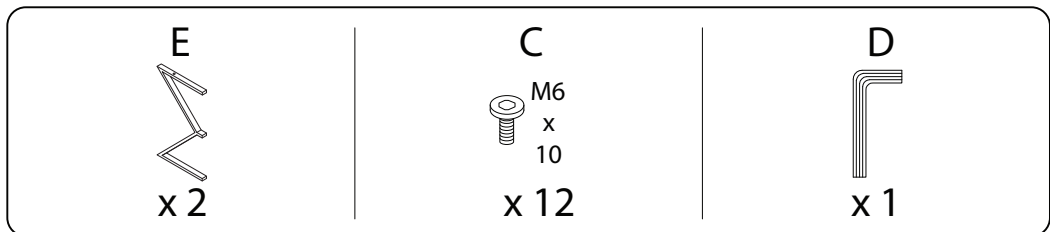

3

F



x 4

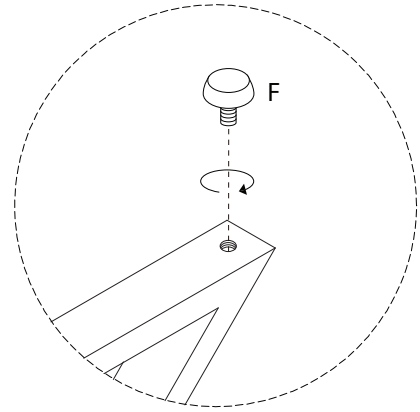
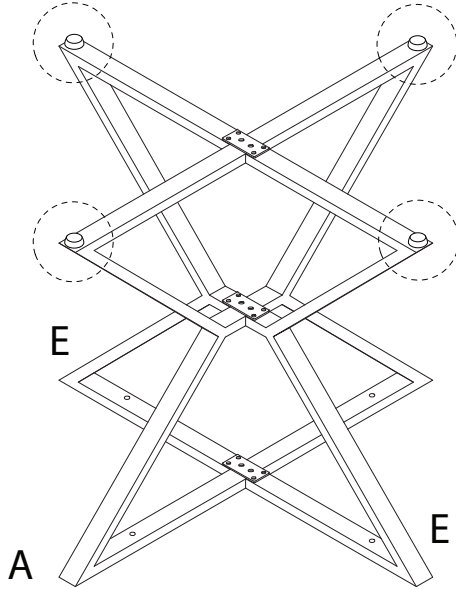

4

G

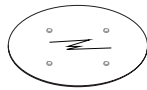

x 1

H

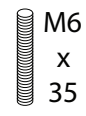

M6
x
35
x 4

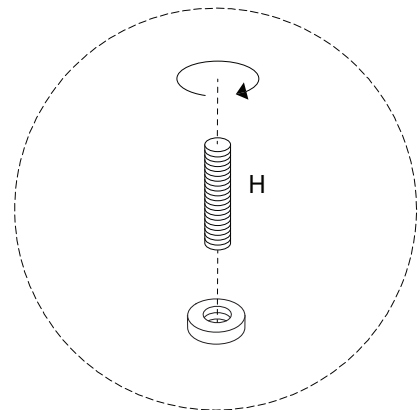
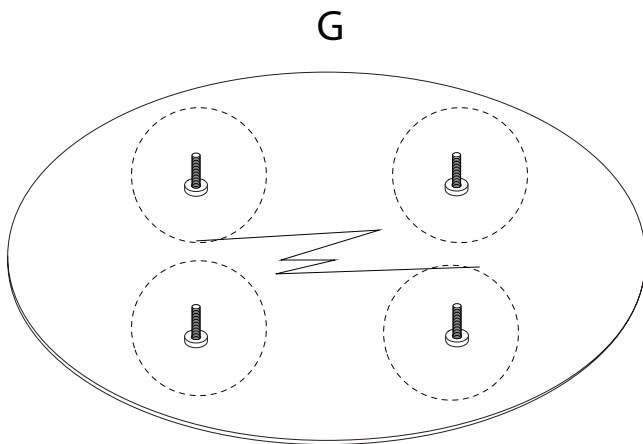

5

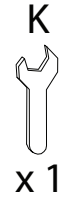
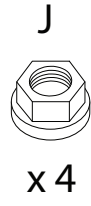
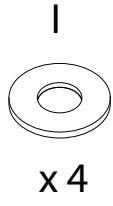

G

