

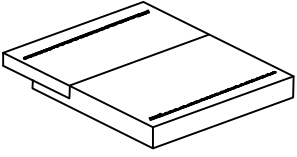

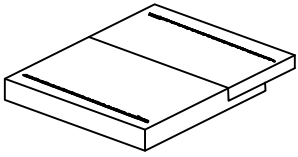
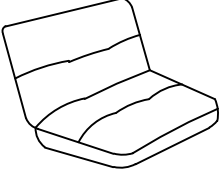
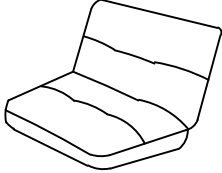
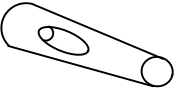
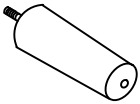
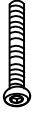
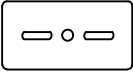
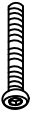

Accessories list(sitting sofa)

<p>A</p>  <p>Right seat frame(1)</p>	<p>B</p>  <p>Left seat frame(1)</p>	<p>C</p>  <p>Right cushion (removable)</p>	<p>D</p>  <p>Left cushion (removable)</p>
<p>E</p>  <p>Sofa legs(2)</p>	<p>F</p>  <p>Middle and back legs(4)</p>	<p>G</p>  <p>8*60 Screw(2)</p>	<p>H</p>  <p>12*5*3 Metal plate(2)</p>
<p>I</p>  <p>8*30 Screw(4)</p>	<p>J</p>  <p>M5 Wrench(1)</p>	<p>K</p>  <p>17mm Gasket(4)</p>	<p>L</p>  <p>15mm Gasket(2)</p>
<p>M</p>  <p>Woolenmat(6)</p>			

STEP 1:

Connect the 2 seat frames with hardware, then install all the sofa legs. Note: Please install the middle legs and 2 back legs with Part F.

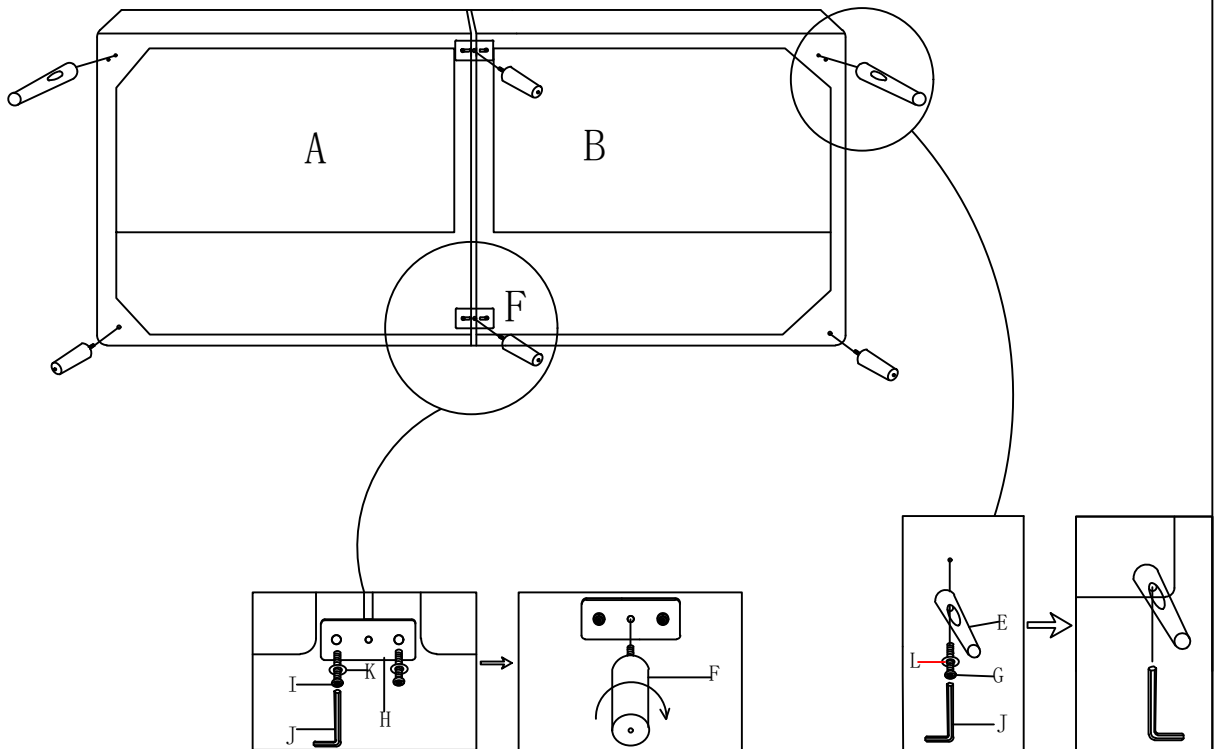

STEP 2:

Cut the compression bags

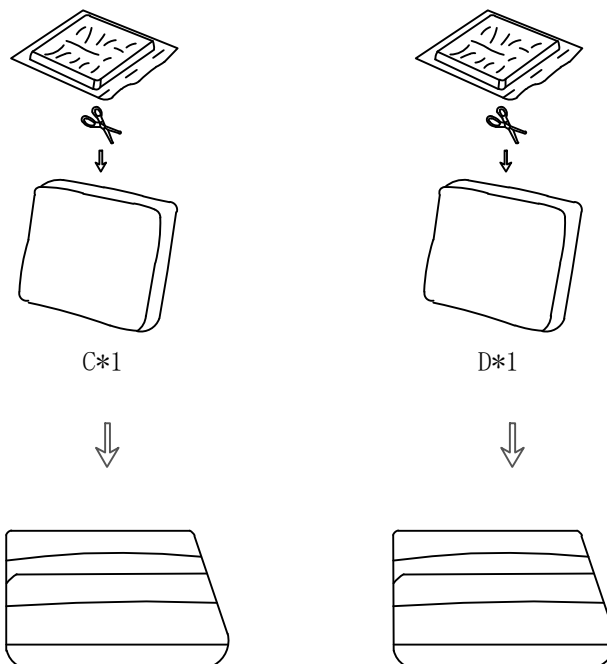

STEP 3: Put the cushions on the sofa , and then zip up the zipper in the front of the seat cushion

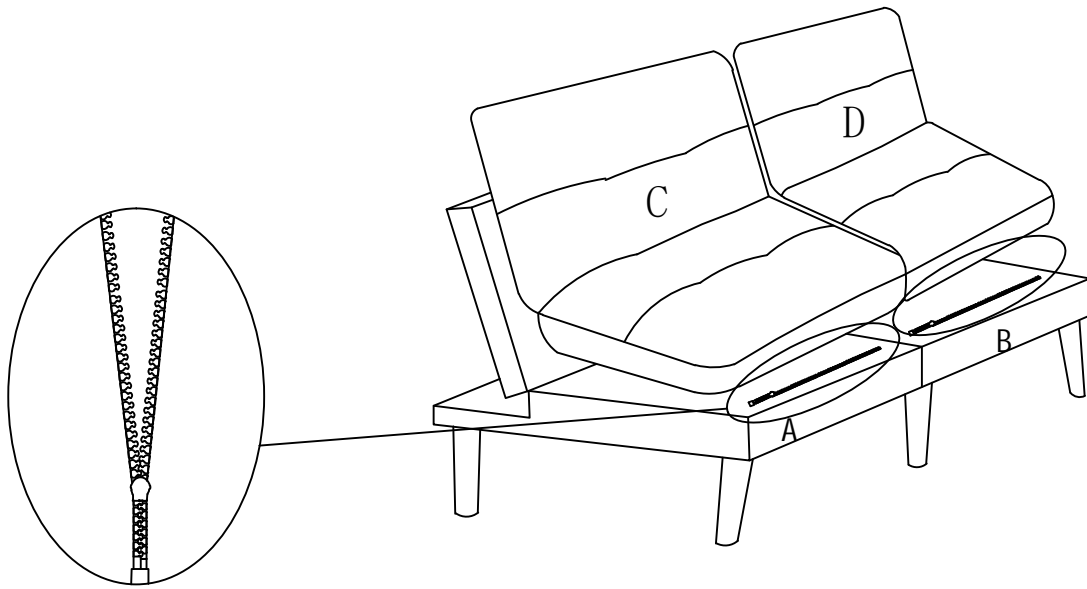

STEP 4: Pull out the fabric cover of the cushions

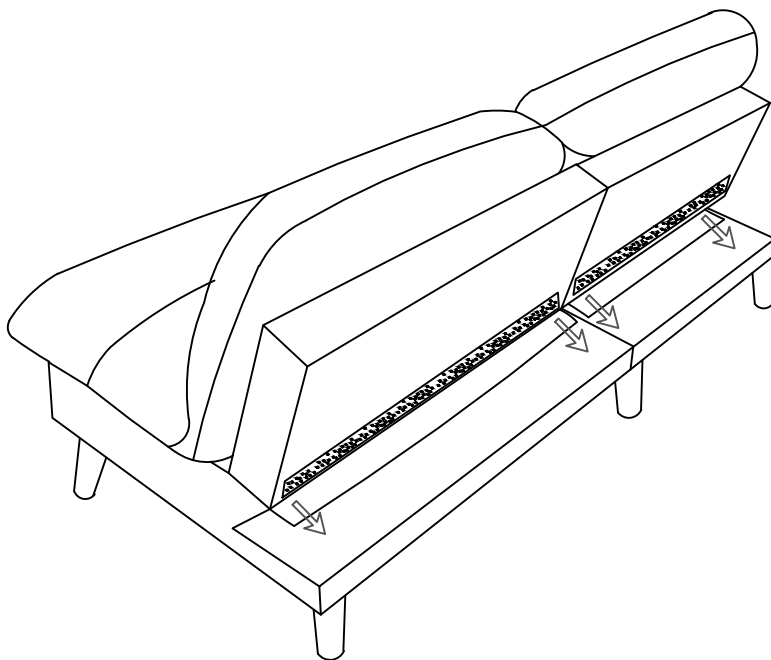

STEP 5: Zip up the zipper at the back of the seat cushion and the backrest

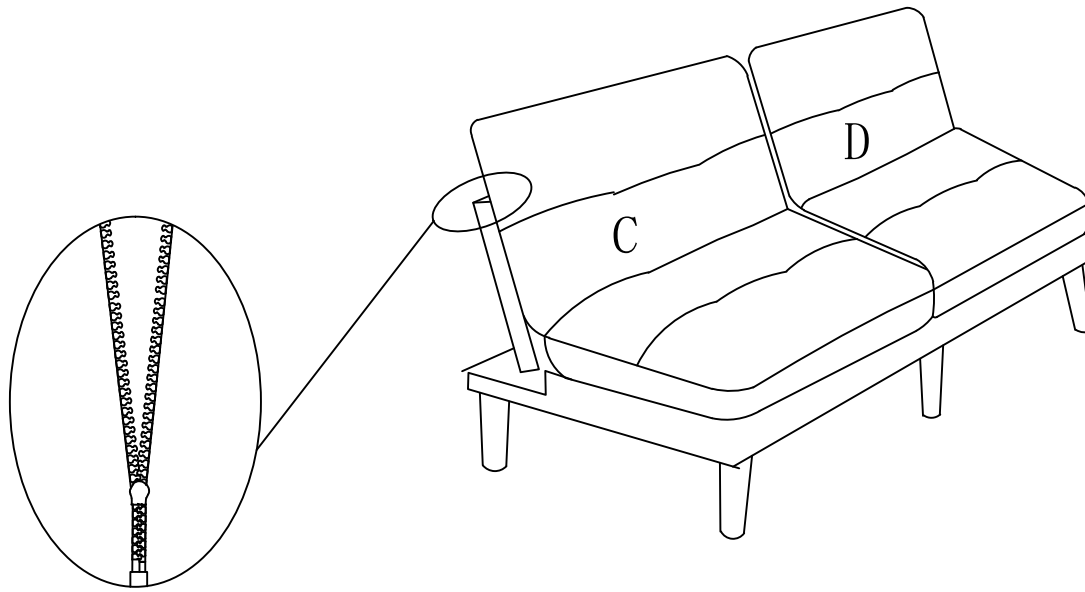

STEP 6: Stick the fabric cover onto the magic tape at the back.

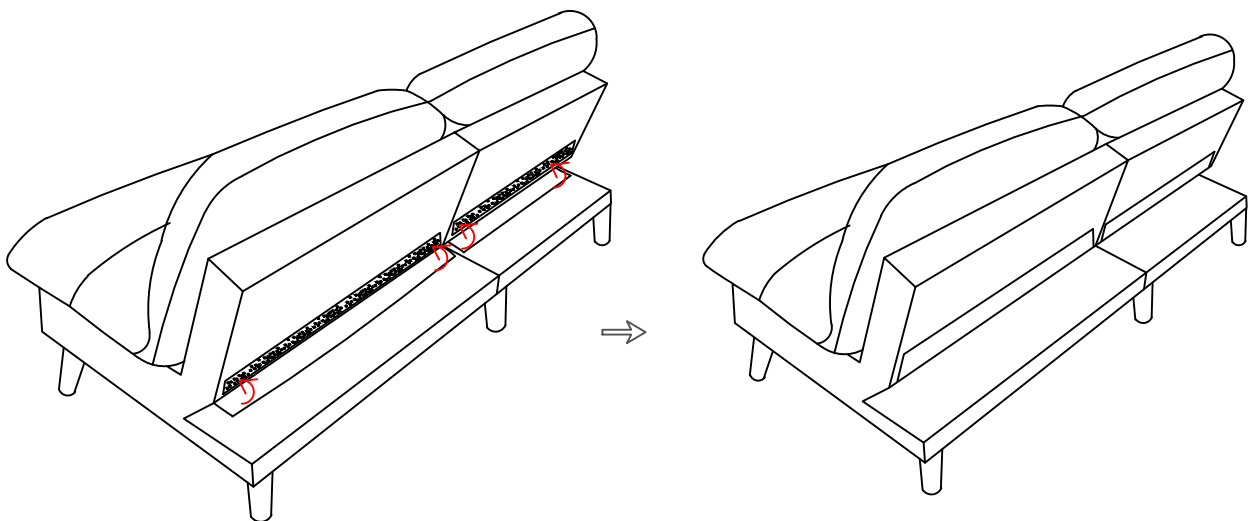

STEP 7: This backrest can be adjusted to three different angles.

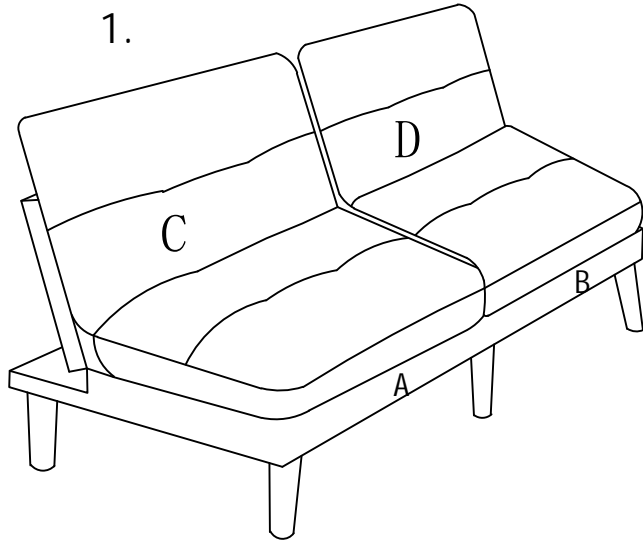

Angle One
 105°

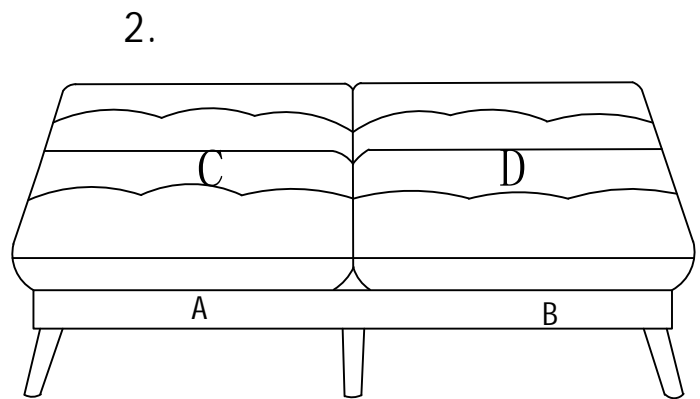

Angle One
 180°

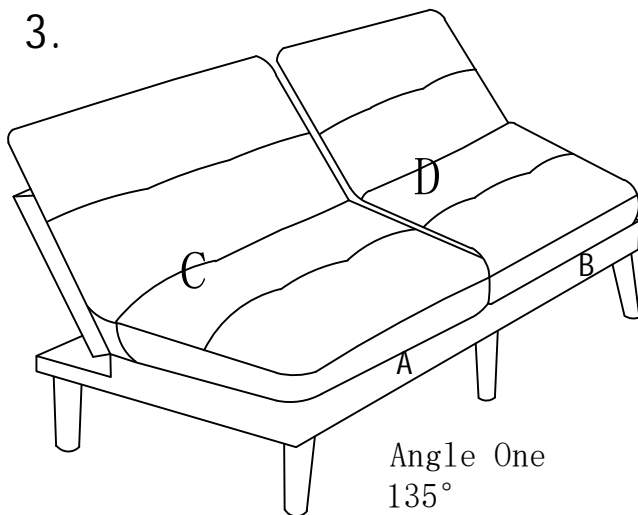

Angle One
 135°