



(A)  x4

(B)  x4

(D)  x5

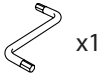
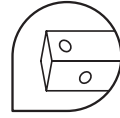

1

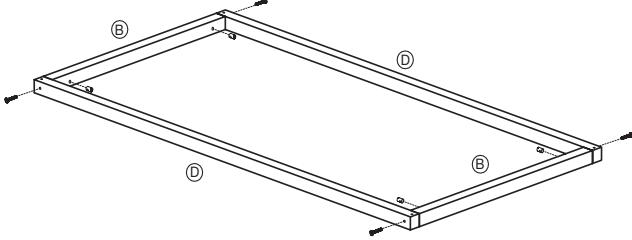
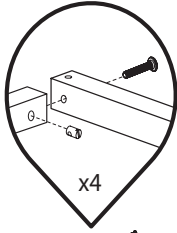

2

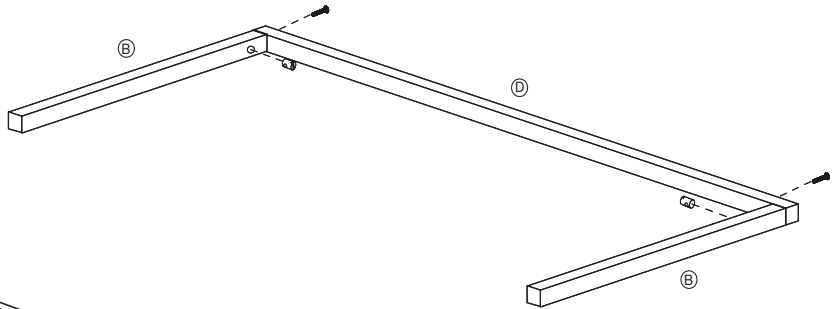

3

