

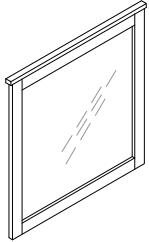

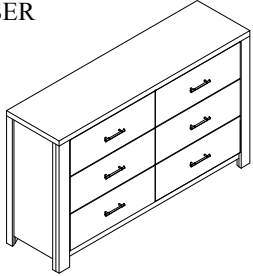
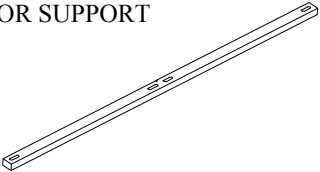
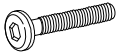

# ASSEMBLY INSTRUCTION

REVISED : A		
NO	PARTS & HARDWARE	QTY.
A	MIRROR 	1 UNIT
B	DRESSER 	1 UNIT
C	MIRROR SUPPORT 	2PCS
D	JCBC M6 x 35mm 	8PCS
E	SPRING WASHER 1/4"mm 	8PCS
F	FLAT WASHER 1/4" x 20mm 	8PCS
G	L KEY M4 	1PC

STEP 1 : ATTACH MIRROR SUPPORT (C) TO THE MIRROR BACK (A)  
AS STEP 1, THEN TIGHTEN WITH JCBC (D), Spring Washer (E) &  
FLAT WASHER (F) BY USING L KEY (G).  
MAKE SURE MARKING LINE OF SUPPORT MUST SAME LEVEL  
AS BOTTOM OF MIRROR BASE.

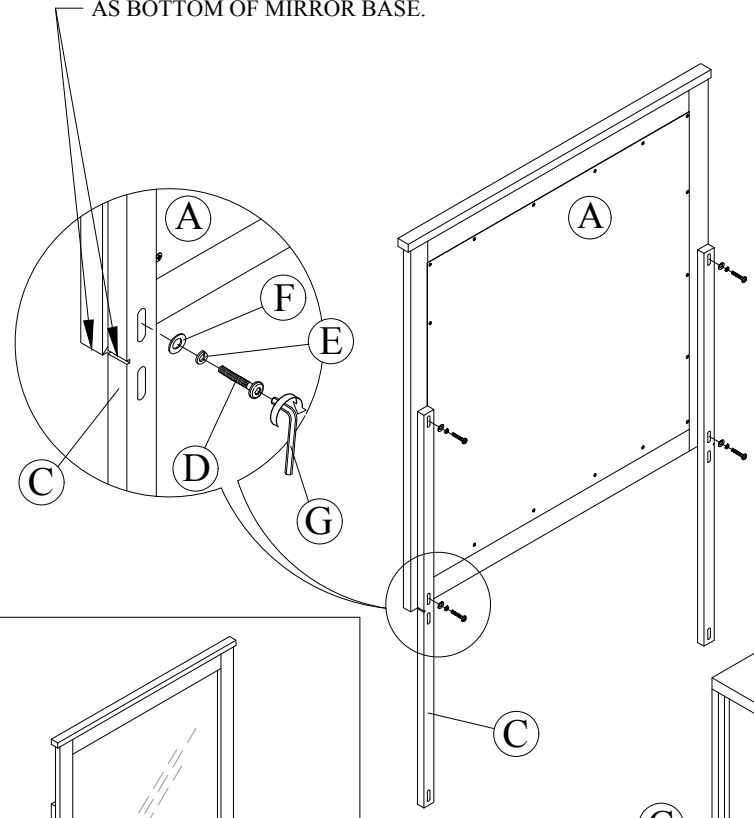

STEP 2 : PLACE THE MIRROR THAT WITH SUPPORT ON THE  
TOP OF DRESSER (B). THEN ALIGN CENTER  
AS SHOWN AND TIGHTEN WITH JCBC (D), SPRING  
WASHER (E) & FLAT WASHER (F) BY USING  
L KEY (G).

