

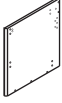

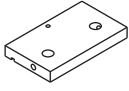

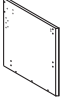

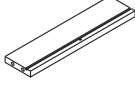

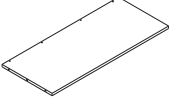
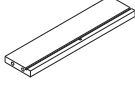
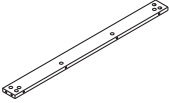
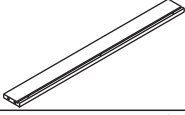
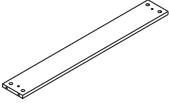
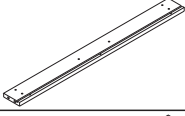
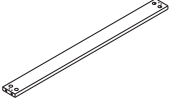
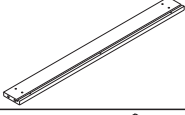
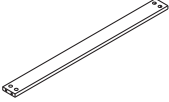
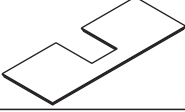
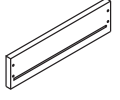
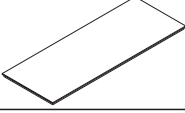
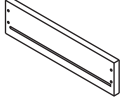
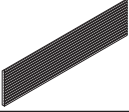
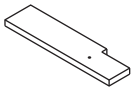
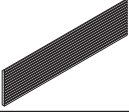
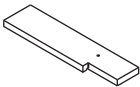

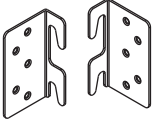
ASSEMBLY INSTRUCTIONS

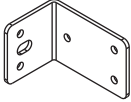
1		x1	12		x1
2		x1	13		x1
3		x1	14		x1
4		x1	15		x1
5		x1	16		x1
6		x1	17		x1
7		x1	18		x1
8		x2	19		x1
9		x2	20		x1
10		x1	21		x1
11		x1			

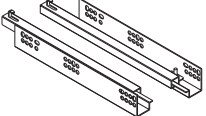
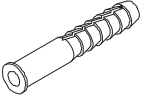
ASSEMBLY INSTRUCTIONS

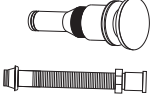
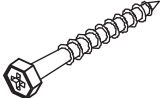
<p>Ⓐ</p>	 $\varnothing 6 \times 26 \text{mm}$	<p>x48</p>	<p>Ⓘ</p>		<p>x1</p>
<p>Ⓑ</p>	 $\varnothing 15 \times 9 \text{mm}$	<p>x48</p>	<p>Ⓙ</p>		<p>x2</p>
<p>Ⓒ</p>	 $\varnothing 3.5 \times 14 \text{mm}$	<p>x59</p>	<p>Ⓚ</p>		<p>x2</p>
<p>Ⓓ</p>		<p>x4</p>	<p>Ⓛ</p>		<p>x8</p>
<p>Ⓔ</p>		<p>x4</p>	<p>Ⓜ</p>		<p>x1</p>
<p>Ⓕ</p>		<p>x4</p>			
<p>Ⓖ</p>	 $\varnothing 3.5 \times 30 \text{mm}$	<p>x19</p>			
<p>Ⓗ</p>		<p>x2</p>			

ASSEMBLY INSTRUCTIONS

Use the Cam Lock and Eccentric Wheel

ECCENTRIC WHEEL

Tighten the bolt until the shoulder is aligned with the panel.
Be sure not to tighten too much or too little.

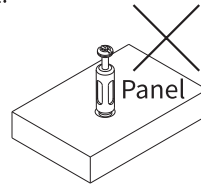
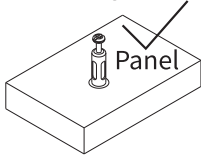

The pre-inserted nut should align with the center of the cam lock when joining two panels. The cam lock should be inserted before the eccentric wheel.

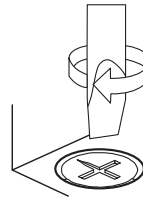
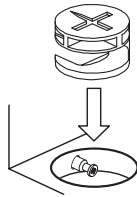

Turn the cam lock clockwise to tighten.

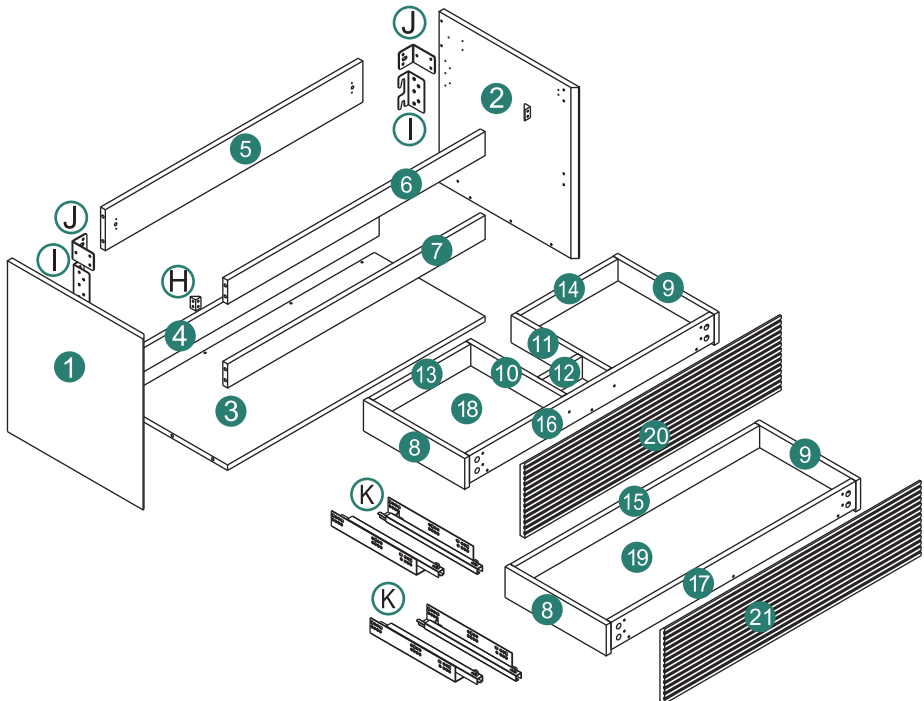

ASSEMBLY INSTRUCTIONS

1



1 1pc



2 1pc



8 2pc



9 2pc



10 1pc



11 1pc



A 48pcs



The floor needs to be covered with paper or carpet protective material before installation!

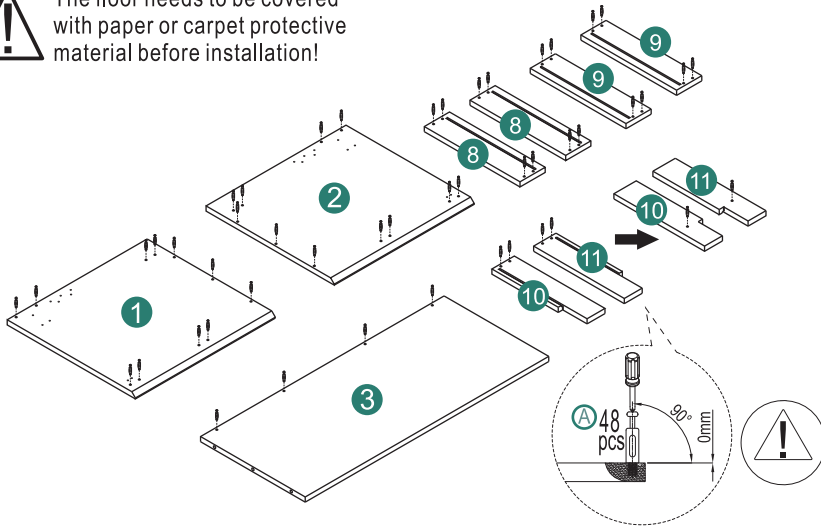

2



1 1pc



2 1pc



3 1pc



4 1pc



5 1pc



6 1pc



7 1pc



B 26pcs

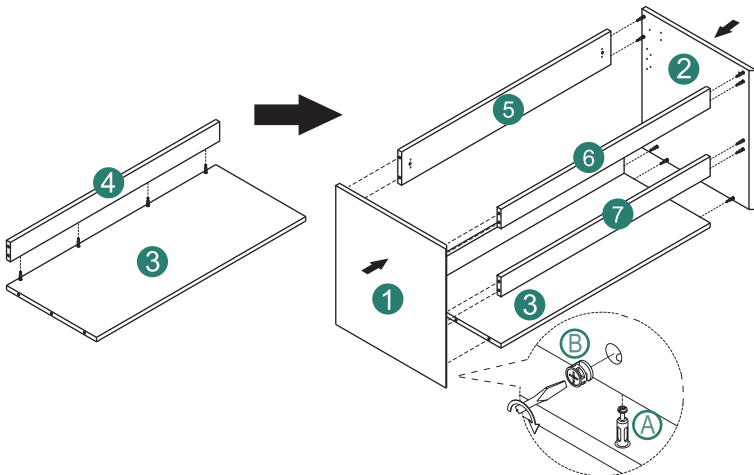

5

ASSEMBLY INSTRUCTIONS

3

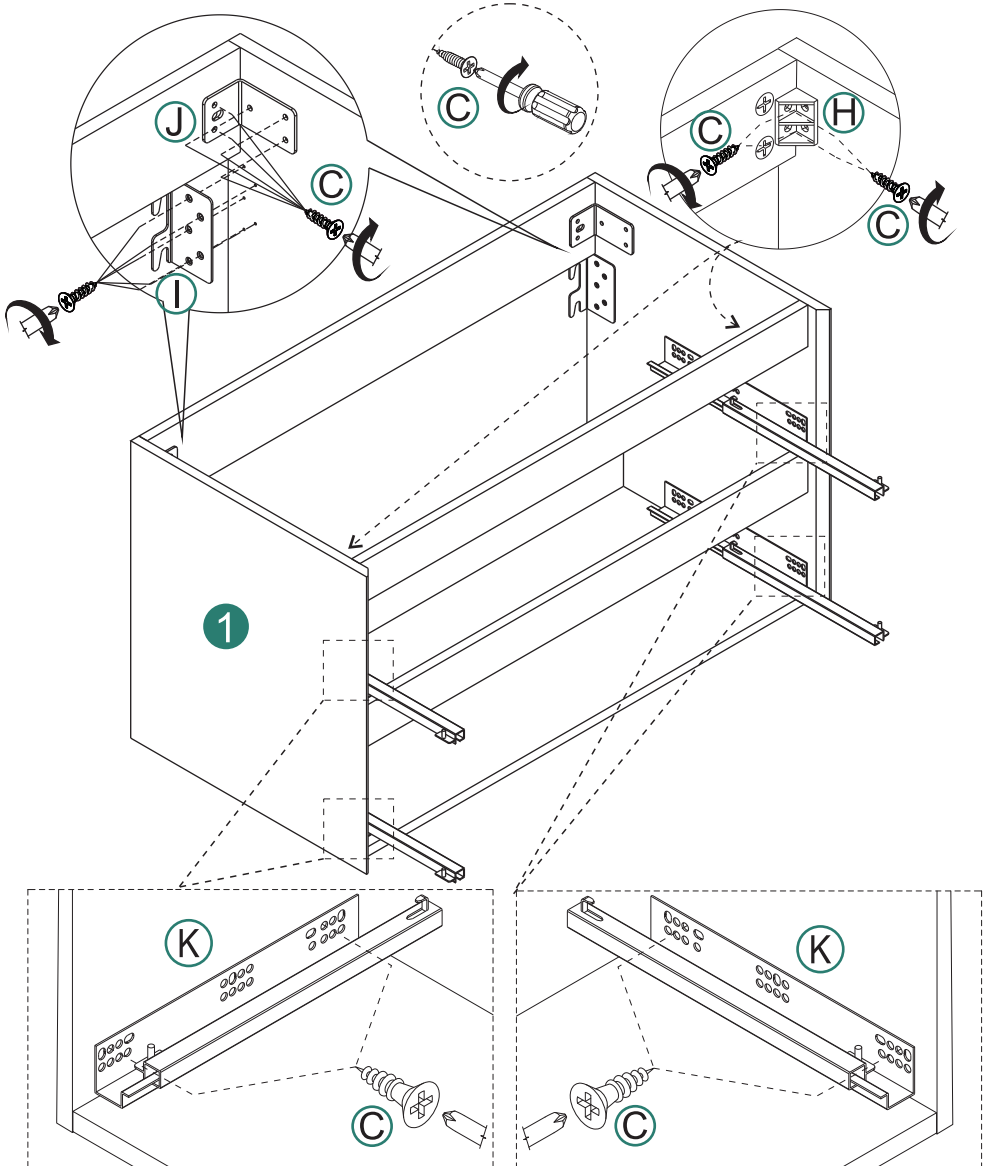
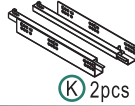

ASSEMBLY INSTRUCTIONS

4

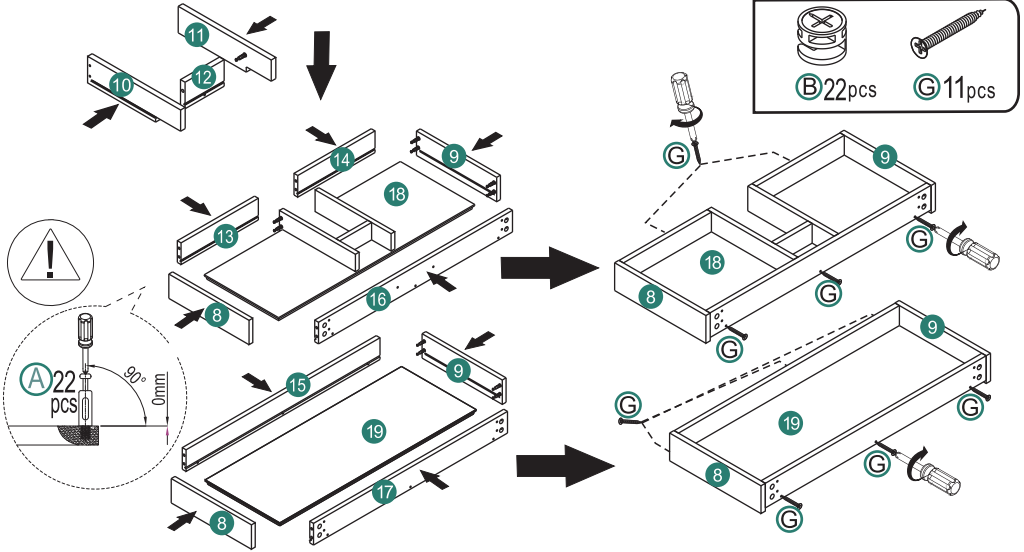
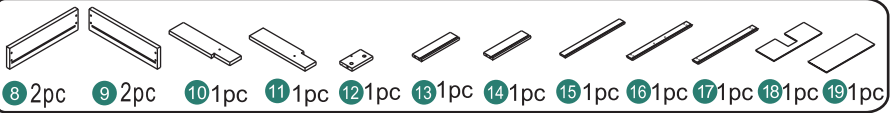

5

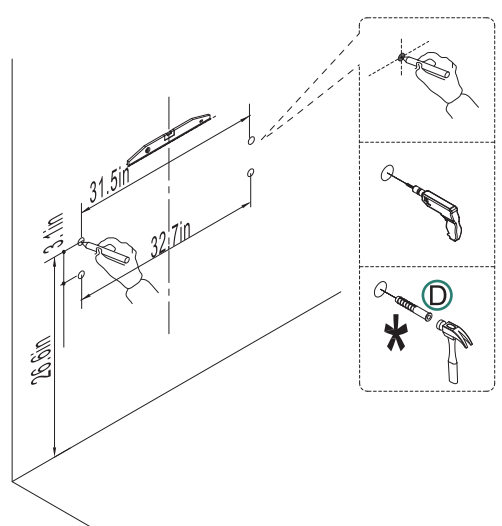
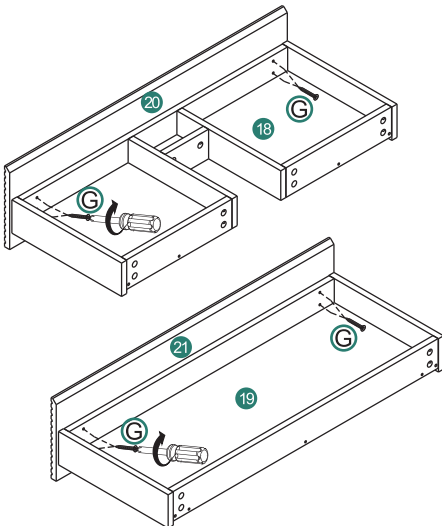

ASSEMBLY INSTRUCTIONS

6



C 8pcs



E 4pca



F 4pca

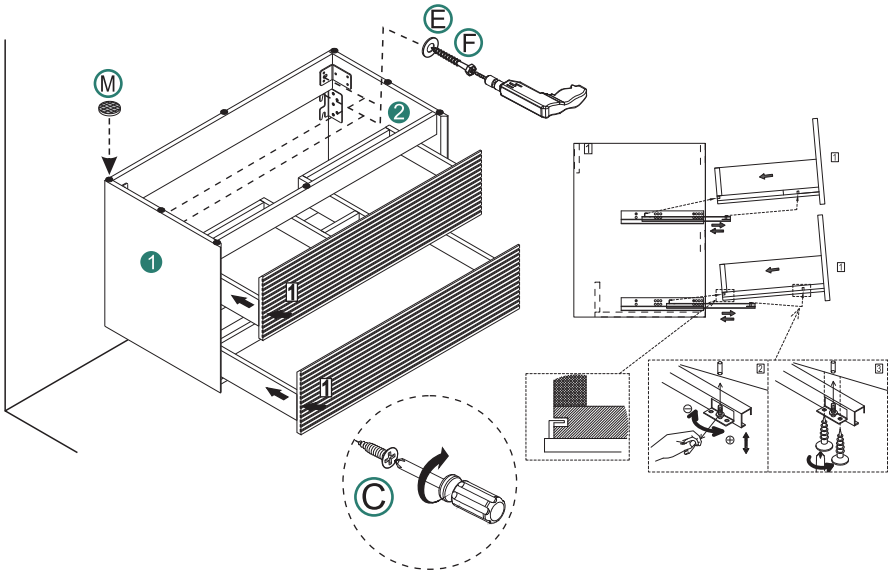

7

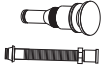

M 1pcs

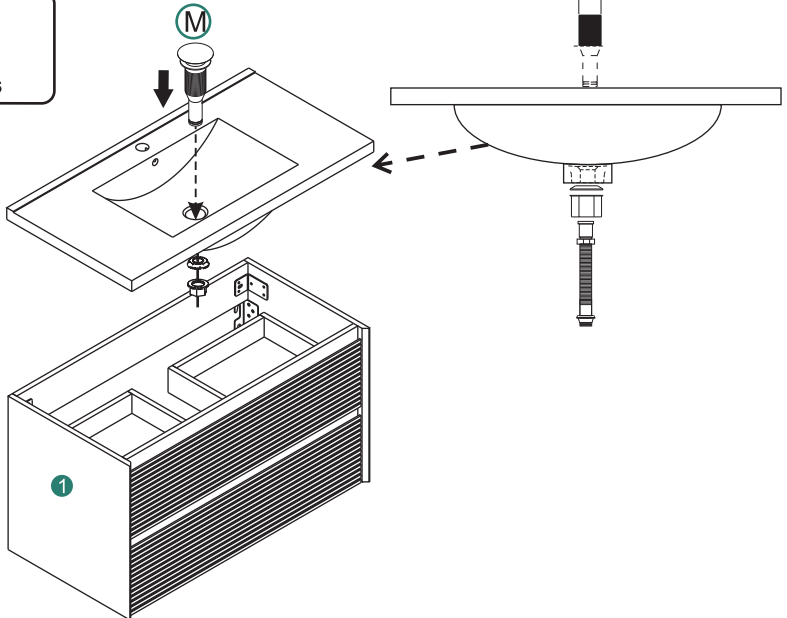

8